

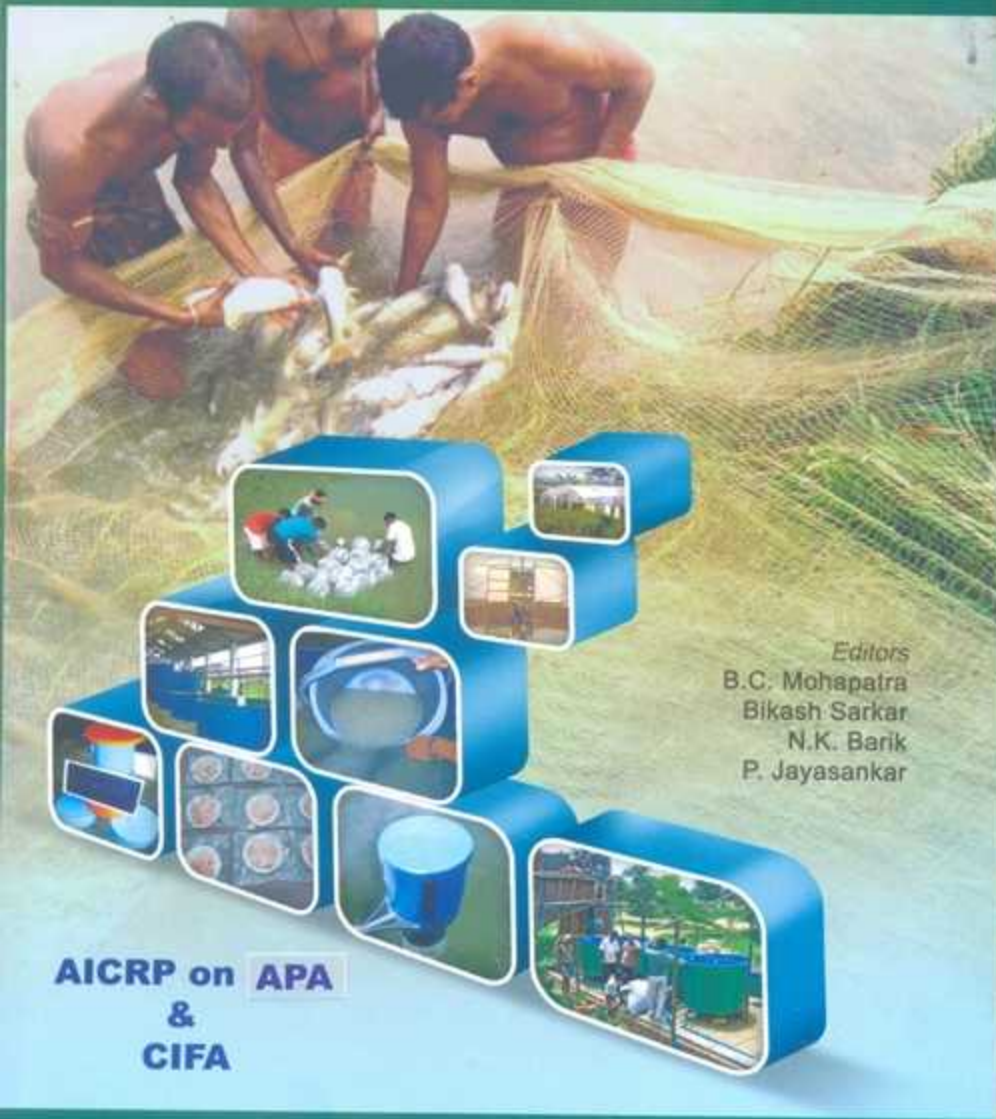

APPLICATION OF PLASTICS IN AQUACULTURE



Editors
B.C. Mohapatra
Bikash Sarkar
N.K. Barik
P. Jayasankar

**AICRP on APA
&
CIFA**

All India Coordinated Research Project
on
APPLICATION OF PLASTICS IN AGRICULTURE

Cooperating Centre
CENTRAL INSTITUTE OF FRESHWATER AQUACULTURE
(Indian Council of Agricultural Research)
Kausalyaganga, Bhubaneswar-751 002, Odisha, India





APPLICATION OF PLASTICS IN AQUACULTURE

Editors

B.C. Mohapatra
Bikash Sarkar
N.K. Barik
P. Jayasankar

All India Coordinated Research Project
on
APPLICATION OF PLASTICS IN AGRICULTURE

Cooperating Centre
CENTRAL INSTITUTE OF FRESHWATER AQUACULTURE
(Indian Council of Agricultural Research)
Kausalyaganga, Bhubaneswar-751 002, Odisha, India

PREFACE

The use of plastics has revolutionised the agricultural production system and has great impact in improving the overall scenario in all the production systems *e.g.*, field crops, vegetables, fruits, fishery, animal production, etc. Enough technologies have been developed in this direction, which is being used by farming communities all over the country. But still, there is long way to go, as so many technologies are still not reached to farmers or the technologies are not fully standardised for Indian conditions. Certainly the use of plastics in such systems are increasing day by day as new and more promising applications are invented and executed along with expansion in present use pattern. But still, Indian agriculture is much behind to realise potential of plasticulture technologies. Along with its use, environment concern is often raised about safe disposal of used plastic materials. Hence, it is time for all including researchers, policy makers and implementer to work out strategies for its use and disposal.

Plastic has found very important use in aquaculture field. Nylon fishnets, plastic pipe framed and nylon net cages, pen culture in water locked areas, etc are some of the important uses of plastics in aquaculture. Under the AICRP, CIFA, Bhubaneswar Centre is working since inception in 1988 and contributed several technologies on application of plastics in aquaculture, which has been found very useful in improving the overall scenario of inland fishery sector. Portable FRP carp hatchery, automatic and demand FRP feeders, solar operated automatic feeders, FRP fish silos for hi-tech aquaculture, HDPE floating cages, live fish transportation tanks, poplyhouse ponds for fish rearing in winter months, PVC aqua filters and freshwater fish packaging are some of important contributions made by the centre.

It is a moment of immense pleasure for me that during the "National Workshop on Portable FRP Carp Hatchery Technology", 11-13, July 2011 at CIFA, Bhubaneswar the APA Centre located at the Institute is releasing the Book on "Application of Plastics in Aquaculture". On this occasion, I would like to appreciate great efforts made by APA team of CIFA, Bhubaneswar in this direction to develop such valuable technologies and popularizing them among users and stakeholders.

On behalf of project team of APA, we like to express gratitude to Dr S. Ayyappan, Secretary DARE and Director General ICAR, and previous Directors, CIFA, Bhubaneswar whose guidance, inspiration, encouragement and support played key roles in success of these technologies. I thank Dr B.C. Mohapatra and his team for compilation of the book.

Thankful to all who directly or indirectly helped or contributed for projects under AICRP on APA at CIFA, Bhubaneswar and elsewhere.

Ludhiana
08 July 2011

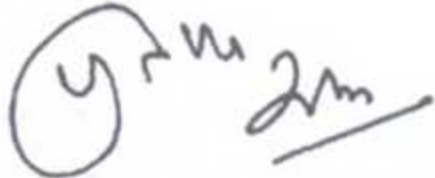
(P.R. Bhatnagar)
Project Coordinator
AICRP on APA
ICAR

PREFACE

Rapid changes in the aquaculture sector have occurred in relatively short period of time. From 0.2 million tonne in 1970-71 aquaculture production in the country has shot up to 3.4 million tonne in 2007-08. This explosive growth of the sector is regarded as 'blue revolution' as compared to 'green revolution' in agriculture. Significant development of the aquaculture technologies led to the improvement of the sector both quantitatively and qualitatively. Plastics have played a major role in various facets of aquaculture development. Central Institute of Freshwater Aquaculture (CIFA) has made considerable effort to increase the scope and application of plastics in aquaculture. The institute in collaboration with All India Coordinated Project on Application of Plastics in Agriculture (AICRP-APA) of Indian Council of Agricultural Research (ICAR) is working since 1989-90 on the application of plastics in aquaculture.

Over 2 decades of the research in the application of plastics in aquaculture have gone through time tested process of innovations, experimentation, iterations and refinements to develop many gadgets and tools. Among them portable hatchery, Silos, live transport system, feeder, poly house pond, packaging material etc. are notable. These gadgets are making significant contributions to the growth and development of the sector. Some of these technologies are fully adopted and accepted by the farmers. This book has attempted a comprehensive review of the work done in CIFA on the application of plastics in aquaculture and has been long overdue. I am glad that it is released during the Silver Jubilee Year of CIFA. Many of the current and past scientists of this great institute have made notable contributions to research in this vital area of aquaculture. Contents of this book will be available to the academic and farming community for posterity. I acknowledge the contributions made by the scientists of CIFA to this important book. I have no hesitation to state that this book will be a milestone in development of aquaculture technologies in coming times.

Bhubaneswar
8 July 2011



(P. Jayasankar)
Director (Acting)
CIFA

Acknowledgements

We wish to record our sincere thanks to Dr S. Ayyappan, Secretary (DARE) & Director General (ICAR), New Delhi; Dr (Mrs.) B. Meenakumari, DDG (Fy), New Delhi; Dr M.M. Pandey, DDG (Engineering), New Delhi and Dr P.R. Bhatnagar, Project Coordinator, AICRP on APA, Ludhiana for their inspiration during research work and help in bringing out this book. We wish to express our sincere thanks to all former DGs, DDGs, ADGs and concerned functionaries of ICAR especially from Fisheries and Engineering Divisions; Dr. S.D. Tripathi, Mr. M. Ranadhir, Dr S. Ayyappan, Dr C. Saha, Dr K.J. Ram; Dr R.K. Jana; Dr N. Sarangi and Dr A.E. Eknath; and Project Coordinators of AICRP on APA Late Dr O.D. Wanjari and Dr Ashwani Kumar. We offer our sincere thanks to all former Project Leaders, APA Project, CIFA Dr M.K. Bandyopadhaya, Dr P.K. Aravindakshan and Dr C. Saha; and our project colleagues Dr S.K. Singh and Dr K.K. Sharma.

At last we would like to thank the persons who have helped us directly or indirectly whose name could not find a separate place as duly acknowledge. It is our pleasure to acknowledge the financial support by AICRP on Application of Plastics in Agriculture, ICAR, New Delhi.

Bhubaneswar
08 July 2011

B.C. Mohapatra
Bikash Sarkar
N.K. Barik
P. Jayasankar

CONTENTS

Sl. No.	Subject	Page No.
	Preface I	iii
	Preface II	v
	Acknowledgement	vii
1	Contributions of Plastics to Aquaculture Development	1
2	Introduction to usable plastics: An Overview	13
3	Fabrication Techniques of Fibre Reinforced Plastics	20
4	Portable FRP Carp Hatchery	32
5	Fish rearing in FRP Silo	43
6	Polyhouse Ponds for Fish Rearing	55
7	Fish Feeders	70
8	Live Fish Transportation System	81
9	Plastic Packaging For Freshwater Fish Processing And Products	89
10	Socioeconomic Context of Impact of Portable Hatcheries in India	97

CONTRIBUTIONS OF PLASTICS TO AQUACULTURE DEVELOPMENT

The aquaculture is a newest chapter in the agricultural development. The fishes are being caught and consumed from the prehistoric dates, but the culture of fish in captivity is the recent developments. The earliest record of aquaculture was in 500 BC in China and Kautilya's Arthashastra - one of the oldest Indian epics indicates that fish culture activity in India dates back to 300 BC. Before introduction of the scientific culture, the fish culture was reported in the eastern part especially in the Bengal areas. The traditional system followed "trapping and holding" of fish seed and raising them to table size, and thus this marked the beginning of aquaculture in India (FAO, 1999). Such system continued till recently in these parts of the country. The organized research on the aquaculture was initiated with the establishment of the Central Inland Fisheries Research Institute in Barrackpore during 1945. Indian Council of Agricultural Research (ICAR) gave great emphasis on aquaculture research and training and established Freshwater Aquaculture Research and Training Center (FARTC) in 1977 under CIFRI at Kauslyaganga, Bhubaneswar, which also housed the Pond Culture Division. The Trainers Training Center (TTC) and Krishi Vigyan Kendra (KVK) were also established there at the same time. This institution later made into independent institute as Central Institute of Freshwater Aquaculture in 1987.

The focused research in the aquaculture has generated many technologies, package and practices and gadgets. Over a period, it has been learnt that the potential of the application of plastic in aquaculture is large and therefore, systematic research on this regards was initiated in CIFA. During the year 1988-89, All India Coordinated Research Project on Application of Plastics in Agriculture (APA) was commissioned with CIFA as a center to look after the aquaculture aspects. The plastics are being applied in many aspects of the agricultural operations which have shown positive results. Similarly, it holds a great promise to improve the aquaculture sector by applications in many aspects from pond management to package for consumption. During last two decades, the research on plastic applications in aquaculture has gone through many phases with diverse experiments and results. These results need to be made available to the new generations to so as to use them for further development in these aspects.

The world population is the total number of living humans on the planet Earth, currently estimated to be 6.93 billion by the United States Census Bureau. The world population has experienced continuous growth since the end of the Bubonic Plague, Great Famine and Hundred Years Wars in 1350, when it was about 300 million.

The highest rates of growth – increases above 1.8% per year – were seen briefly during the 1950s, for a longer period during the 1960s and 1970s; the growth rate peaked at 2.2% in 1963, and declined to 1.1% by 2009. Annual births have reduced to 140 million since their peak at 173 million in the late 1990s, and are expected to remain constant, while deaths number 57 million per year and are expected to increase to 80 million per year by 2040. Current projections show a continued increase of population (but a steady decline in the population growth rate) with the population to reach between 7.5 and 10.5 billion by the year 2050 (UNO, 2009). In 1798, Thomas Malthus incorrectly predicted that population growth would out-run food supply by the mid-19th century. In 1968, Paul R. Ehrlich reprised this argument in *The Population Bomb*, predicting famine in the 1970s and 1980s. The dire predictions of Ehrlich and other neo-Malthusians were vigorously challenged by a number of economists, notably Julian Lincoln Simon. Agricultural research already under way, such as the Green Revolution, led to dramatic improvements in crop yields. Food production has kept pace with population growth. From 1950 to 1984, as the Green Revolution transformed agriculture around the world, grain production increased by over 250%. The world population has grown by about four billion since the beginning of the Green Revolution and most believe that, without the Revolution, there would be greater famine and malnutrition than the UN presently documents (approximately 850 million people suffering from chronic malnutrition in 2005). Therefore, the challenges to the food supply can only be faced with the agricultural research and development.

The fisheries sector also responding positively to the challenges. The research on the breeding and culture of fishes were initiated in the country during fifties, but the actual technological development started in early seventies when the seed production and culture of fishes has been developed. Since then, the sector has grown in leaps and bounds maintaining a growth rate of about 6.2 % during last 25 years. The technologies of the aquaculture are evolving at rapid pace and therefore, the application of the research and development in other fields is welcome to the sector. One of such development is the plastic application in agriculture. The use of plastics in agriculture / aquaculture in the country has increased rapidly, and has acquired substantial significance in the conversion of material and energy, contributing greatly to the increased production of agricultural produce.

The plastics are perhaps the most versatile of the materials known. They being synthetic can be tailor made to meet the very specific performance requirements of the end-use. By virtue of their versatility, plastics are fast replacing the conventional materials such as wood, glass, metals, papers, etc. in vary varied segments like agriculture, irrigation, water management, aquaculture, packaging, etc. India has witnessed a

substantial growth in the consumption of plastics. Packaging is the major plastics consuming sector, with 42% of the total consumption, followed by consumer products and the construction industry. Elasticities of the individual material growth with respect to GDP were established for the past and for the next three decades estimated for India thereby assuming a development comparable with that of Western Europe. On this basis, the total plastics consumption is projected to grow by a factor of six between 2000 and 2030. In India, plastics consumption grew exponentially in the 1990s. During the last decade, the total consumption of plastics grew twice as fast (12% p.a.) as the gross domestic product growth rate based on purchasing power parities (6% p.a.). The current growth rate in Indian polymer consumption (16% p.a.) is clearly higher than that in China (10% p.a.) and many other key Asian countries. The average Indian consumption of virgin plastics per capita reached to 3.2 kg in 2000/2001 (5 kg if recycled material is included) from a mere 0.8 kg in 1990/1991. However, this is only one-fourth of the consumption in China (12 kg/capita, 1998) and one sixth of the world average (18 kg/capita).

The plastics most commonly used in aquaculture are Low Density Polyethylene (LDPE), High Density Polyethylene (HDPE), Polyvinyl Chloride (PVC), Polypropylene (PP), Polystyrene (PS), Polyamide (nylon), Polycarbonet (PC), Acrylic (PMMA), Fibre Reinforced Plastics (FRP), etc. The application of plastics in aquaculture and fisheries is very limited in India. In general, plastics are in use for packaging of processed fish, making of crafts and gears, etc. For effective utilization of plastics in agriculture in India, during 1988 ICAR has launched an All India Coordinated Research Project on "Application of Plastics in Agriculture". Under this project a Co-operating Centre on Use of Plastics in Aquaculture was established at Central Institute of Freshwater Aquaculture, Bhubaneswar. During its inception this Centre has developed various plasticwares for aquaculture purposes. The research in application of the plastics for aquaculture since two decades has produced many products which have been evaluated in the research stations as well as farmers fields for their applicability. At present, many of these gadgets are at the different levels of development, evaluation and adoption. The brief overview of these applications is presented in the chapter.

1.1. Carp Hatchery

Breeding of carps was undertaken traditionally using bundhs, hapas and recently by Chinese circular breeding pools which are having their own merits and demerits. Deviating from the above, a new breeding channel was developed with FRP suitable for small farmers (Aravindakshan *et al.*, 2000a). The developed breeding channel of 6.0 x 0.6 x 0.5 m is suitable for breeding of carps. The out let of the tank is connected to the FRP incubation tank of 1 million-egg capacity. This is a hybrid breeding system with principles of bundh and induced breeding, where the selected broods are released

after injection of inducing agents. The water flow of 6-15 l / min depending on the species and also density is provided. The fish breed in the system and the released eggs flow along with water, and automatically collected in the hatching pool connected to it. The system is suitable in field conditions for breeding of carps viz., Rohu (*Labeo rohita*), Catla (*Catla catla*), Mrigal (*Cirrhinus mrigala*), Kalbasu (*Labeo calbasu*), Common carp (*Cyprinus carpio*), Silver barb (*Puntius gonionotus*), etc. For breeding, 5 - 8.5 kg of brooders (fish) can be placed in the tank for effective spawning.

The AICRP on Application of Plastics in Agriculture (ICAR), Centre at CIFA, Bhubaneswar has designed and developed the complete set of hatchery system in FRP for carp fish breeding and hatchery rearing of seed (Mohapatra *et al.*, 2003; 2004; 2005 & 2008). In one operation it can produce 1.0 - 1.2 million spawn. The system consists of four major parts *i.e.*,

- Breeding/ spawning pool
- Hatching/ incubation pool
- Egg/ spawn collection chamber, and
- Overhead storage tank/ water supply system

The Breeding pool is of 2.15 m diameter, 0.9 m height, 1:22 bottom slope and 3409 l capacity (operation capacity: 2950 l). To provide water circulation inside the breeding pool 5 numbers of 15 mm dia rigid PVC elbows, carrying nipples fitted in the same direction. A single point water inlet of 25 mm diameter is also fitted at the sidewall of the bottom. All the water inlet pipes are inter connected and fitted with individual full way valves to regulate the flow of water. One or two showers are provided at the top for better aeration. The flow rate during egg collection is maintained 1-1.5 l/sec. The system is suitable for fish breeding of 10-12 kg of carps in single operation.

The Hatching or incubation pool is of 1.4 m diameter, 0.98 m height, 1,400 l total volume and 1,200 l net egg incubation volume with a FRP inner chamber (0.4 m diameter and 90 cm height covered with nylon bolting cloth of 0.25 mm mesh to filter the excess water to the drain), water supply system through six numbers of 15 mm dia duck-mouths fitted at the bottom of the hatchery at 45° angle. It also has drainage outlets fitted at the center and at the outer chamber of the pool. It has the capacity of hatching 1.0 - 1.2 million eggs per operation. The flow rate in the pool during operation is maintained at 0.3-0.4 l/sec.

The Eggs/ spawn collection tank is of rectangular with a size of 1.0 ´ 0.5 ´ 0.5 m with water holding capacity of 250 l. The water level in the tank is maintained at a height of 0.45 m (net water volume 225 l) by fixing the drainpipe of 63 mm diameter at a distance of 38.7 cm from the bottom. Cotton inner hapa of the tank size is fixed inside it to collect eggs/ spawn from breeding/ incubation pool, respectively.

The Water storage tank (not supplied with the unit) of minimum capacity 2000 l is required to operate the hatchery unit. The breeding pool and hatching pool are connected to the water storage tank separately or together in the same water line.

1.2. Catfish Hatchery

The catfish hatchery system consists of the following items. The egg incubation unit consists of 16 numbers of HDPE circular tubs (40 cm dia and 10 cm ht) each fitted with PVC inlet pipe (15 mm dia) associated with a tap. An outlet of PVC pipe (6 mm dia) is provided to each tub and the whole system is kept on a metallic frame (table type -90 cm ht). The larval rearing unit consists of 8 numbers of rectangular (90 x 45-x 20 cm) FRP trays with water inlet facility by using PVC pipes (25 mm dia). Facilities are also provided for excess out letting of water through siphoning system. The post- larval rearing unit consists of two numbers of FRP rectangular tanks (2.97 x 0.54 x 0.30 m each). Each unit is provided with water receiving arrangement through PVC pipe (25 mm dia). The egg incubation unit, larval rearing and post- larval rearing units are interconnected in series and are having facilities to receive water from a common source with full way valves.

1.3. Seed Rearing Tanks

The FRP translucent tanks of 1.52 m dia with height of 1.0 m are designed and fabricated with 1 mm thick FRP translucent sheets These are used for high density rearing of fish seed. Systems of re-circulatory water supply, aeration and bio-filtration are incorporated for rearing of spawn to fry, fry to fingerlings and fingerlings to juveniles with high survival and production compared to that of normal method of culture. Due to their unique features of easy handling, abrasion resistance, corrosion resistance, temperature resistance and easiness to incorporate to any type of fittings required to increase the efficiency of the rearing systems, the FRP pools are suitable for using in the aquaculture purposes.

1.4. Cages

Floating plastic cages are designed and fabricated using Rigid PVC pipes and FRP floats. The cages of 3.0 x 3.0 x 1.5 m each of 6 numbers are arranged in parallel in two rows with a wooden walkway in between (Bandyopadhyay *et al.*, 1991b). In each corner of all the chambers, FRP floats (45 cm dia and 32.5 cm ht) are attached to hold the total structure above the water surface. A 3 inch diameter RPVC (Sch-80) is fitted in the centre of the float and is equipped with four numbers of RPVC short pieces (63x 250 mm) in a crosswise direction from the top at distances of 7.5, 17.5, 27.5 and 37.5 cm respectively. To make the cage frame for holding nets, 2 inch diameter RPVC (Sch-80) is pushed inside the socket in all directions with nuts and bolts. Five numbers of metallic/ plastic drums (25 l cap) are used for providing floating support to the wooden walkway. Series are set side by side with a central walkway.

The circular cages of 5.0 and 7.0 m dia are made of 75 mm OD HDPE pipes (double collar) with vertical fencing for carps. The smaller cages fabricated for catfish culture are of 1.0 m diameter and 1.2 m ht made of 25 mm dia Rigid PVC pipes (Sch-80). All the sides of the cages are covered with plastic mesh. The cage is kept in floating condition in the water body by attaching 4 numbers of HDPE floats.

The rectangular cages of 13.0 x 7.0 m size with two chambers are made of GI pipe structures supported with HDPE drum floats (Photo 8). These cages float in reservoirs having more than 5.0 m depth for rearing different fish species. The size of the cages vary according to the need, species of culture, depth of the water body, size of the water body, wind velocity, water current, availability of finance, expertise, materials, etc. Easiness of stocking, harvesting, feeding and monitoring of biological parameters along with the high production potential in the system make it quite adaptable to the aquaculturists.

1.5. Pens

Pens are made with plastic netting (HDPE) materials supported by bamboo / wooden poles at the out let channel of the farm or at the shallow depth of the reservoirs, lakes, etc. Fishes are stocked in the pen and maintained with traditional methods of feeding. In this type of culture, 85-90% of survival is observed. The pens are also used for brood stock management, mono/ polyculture practices, etc.

1.6. Polyhouse Ponds

Water temperature is the key factor for fish growth. During winter periods in low temperature regions, the metabolic activity is greatly reduced, there by affecting the fish production. To maintain the high water temperature in ponds for fish growth during winter periods, two polyhouses of 13 x 8 m are made over two ponds of 11 x 7 m with G. I. Pipe frame structure covered with UV stabilized LDPE film of 250 micron thickness at CIFA. Experiments with *Labeo rohita* for two consecutive winter periods have shown the production level of 3066 – 5896 kg/ha/yr under polyhouse conditions against 1332 –2749 kg/ha/yr in control ponds (Bandyopadhyay *et al.*, 2000). Trials on carp culture indicated that higher production levels of 114 –130 % could be obtained in polyhouse ponds compared to that of control ponds during cold periods. Generally, the temperature maintained at higher side upto 4 -6°C in polyhouse ponds (Mohapatra *et al.*, 2002). Then after several fish rearing experiments are conducted in GI framed and bamboo polyhouse ponds at CIFA.

1.7. Fish Transportation Tank

Transportation of live fishes in large quantities is always a problem for aquaculture due to lack of proper transporting devices. Use of oxygen filled polyethylene bags is

popular among the fish farmers for transportation of fish seed. Transportation of larger fishes including brood fishes is still facing difficulty. Considering the above factors, a FRP live fish transportation tank is designed and fabricated at the APA Workshop of CIFA, Bhubaneswar. (Aravindakshan *et al.*, 2000b).

It is rectangular in shape (1.6 x 0.8 x 1.0 m) with volume 1,280 l suitable for transporting in a jeep trailer or in a power trailer / trolley. It is provided with a top door of 0.66 x 0.4 m for water filling and loading of fishes, and a rear side door of 0.3 x 0.25 m at the bottom to drain the water and to release fishes. A vent pipe of 25 mm is provided at the top for facilitating the supply of air / oxygen at the time of necessity. The tank is well suited for transportation of live table fishes for marketing. The experiment indicated that carps of 425 - 1095 g require 19.74 -70.58 mg O₂ / kg fish / hr. The transportation tank with 1,000 l of water fill is able to transport around 100 kg of carps varying the size from 425 - 1095 g for one hour with partial oxygenation for 10 minutes at every 30 minutes (Aravindakshan *et al.*, 2000c).

1.8. Aqua Filter

Optimum water quality is the prime requirement for the wellbeing of fishes in aquaria. Normally aquarium water gets spoiled frequently due to accumulation of fish excreta and uneaten food besides other decaying organic matter. Maintenance of water quality in aquaria is always a problem. Cleaning of aquaria is a regular affair for aquarium keepers, that spends hours for cleaning and changing water. Due to the frequent change of water, the fishes get disturbed and take much time to adjust to the water qualities besides disturbing the entire settings of the aquarium. To remove the excreta and uneaten food, to maintain the water quality in optimum conditions and for the wellbeing of fishes, an FRP aqua-filter is designed and fabricated at the APA Workshop of CIFA (Aravindakshan *et al.*, 2000d). It is cylindrical in shape with 250 mm diameter with a conical bottom connected with an out let. Different filtering media such as stones, pebbles, charcoal, sand, wool, etc. are filled inside the chamber of the filter. It is having inlet to the aquarium at the bottom and outlet at the top connected with an airlift pump. Back washing facility is also provided in the filter. In operation, the filter can pump 48 l of water / hour.

1.9. Silos

Culture of fishes in silos/ vertical tire system is a new approach, where, the stocking densities are dependent on the volume of water as well as to the height of silos. The new hi-tech system of fish culture is like that of the re-circulatory systems. Flow-through facility can easily be incorporated in the silos for high fish production.

1.10. Fish Feeder / Feed Dispenser

Fish feed is the single most important component in different production systems. The economy of a fish farm is greatly dependent on the efficiency with which the fish utilize the food supply. It accounts for more than 50-70% of the total operating costs depending on the type of feed used and the intensity of other management practices. Different traditional feeding systems are vogue in India, but there is no scientific evaluation of the efficiency of those feeding systems. Mostly farmers adjust the quantity of feed dispersed by simple turbidity determination of water. In traditional feeding system, wastage of feed is higher because of primitive way of feeding and also involves more recurring expenditure due to labour involvements. Keeping in view, demand and automatic feeding systems are introduced that will not only economize the culture operation, but also, reduce the feed loss, maintaining the environmental make-up of the system (Mohapatra *et al.*, 2009).

1.10.1. Automatic Fish Feeder

An Electro-magnet operated automatic fish feed dispenser of 30 l capacity consisting of four major components *viz.*, Feed hopper, Hopper lid, Housing box and Floating buoy is designed and fabricated for operation in aquaculture system. The feed dispenser is fabricated using FRP. The housing box incorporates an opening- closing mechanism (Sliding door), electro- magnet/ solenoid, converter, time switch and contractor inside the box. The sliding door fitted with the channel is mounted inside the housing box below the opening of the feed hopper. The end of the sliding door is connected directly with the soft iron core of the solenoid by mechanical fastener. The sliding movement of door starts when the magnet is energized. The time switch consists of a 15 min interval timer, controls the time of day when the feeder is activated. It can operate a maximum of twice per hour (two periods of 15 min ON and 15 min OFF) or as frequently as once every 24 hours. The quantity of feed delivered per activation cycle is controlled by adjusting the dials of the captive segments of the timer which can be radically pulled out or pressed in while rotating, when actuating mechanisms come in contact with the pulled out segments. The feed outlet can be adjusted by putting different diameter of PVC bush to deliver finer or larger particles respectively. The total feeding unit is placed on the floating structure consisting of HDPE floats fixed on a wooden frame for easy loading of feed materials inside the feed hopper and for its easy installation at the pond site.

1.10.2. Demand Fish Feeder

A demand fish feeder of FRP materials with an angle of repose 50° is designed for pelleted feed for pond culture systems. The main components of the feeder are 30 l capacity Feed hopper and activated mechanisms. The feeder is designed to be installed

in a pond with the activating mechanism extending into the water through an activator rod. Feed drops by gravity onto an adjustable 100 mm diameter and 5 mm thick circular acrylic feed platform positioned below the hopper and above the water level. An acrylic tube of 200 mm OD and 150 mm ht protects the feed platform. The bait-rod (Bright steel of 6 mm dia and 750 mm length.) is suspended from the conical tube on V- shaped steel wire that holds the rod. The feeder is suspended from a M. S. Pulley of 15 kg capacity, which can move on a steel wire fixed over the ponds.

1.11. Other Areas of Application

In addition, there are many other areas of the application of plastics in aquaculture. Some of them are viz., (i). Twines, ropes, net webbing, monofilament for making nets and hapas, etc., (ii) Pipes and fittings for water supply, aeration and drainage, (iii) Tubs, buckets, trays, basins, storage tanks and pools for water holding, (iv) Film for pond lining to prevent seepage, making fish seed transportation bags and live food culture, (v) FRP raceways and re-circulatory structures, shellfish breeding and culture systems and other plastic wares for research purposes. Besides, there are numerable other applications which often goes unnoticed but contribute significantly to the fisheries and aquaculture.

1.12. Summary

The rapid expansion of the application of plastics has been experienced in all walks of the life. It has been observed that use of the plastics is directly and positively related to the development of the economy. It has many applications in agriculture so also in fisheries and aquaculture. The APA and CIFA have collectively made systematic research in developing tools and gadgets potentially useful for aquaculture. The materials, design and dimension of these products are put into experiments to evaluate its applicability, adoptability and efficiency in research stations as well as farmers field. These products are the various stages of the development as some has been in the farmers' field and some are at the research stations. Therefore, this book makes a complete assessment of the research and development on the application of plastics in aquaculture. The summary of the most important applications are presented in each chapter as review of past works. The review can help the future generation to give a proper guidance to do research and development in important aspects of the aquaculture development in India.

References

- Aravindakshan, P.K., Bikash Sarkar, S.K. Singh, D. Majhi, and S. Ayyappan, 2000a. Fiberglass reinforced plastics open enclosure breeding system: A new approach. Abstract. *The Fifth Indian Fisheries Forum*, 17-20 January, 2000, CIFA, Bhubaneswar, India, p. 133.

- Aravindakshan, P.K., Bikash Sarkar, S.K. Singh, D. Majhi and S. Ayyappan, 2000b. FRP live fish transportation tank- An aid to freshwater aquaculture. *The Fifth Indian Fisheries Forum*, 17-20 January, 2000, CIFA, Bhubaneswar, India, p. 20.
- Aravindakshan, P.K., S.K. Singh, Bikash Sarkar, K.C. Pani, H.K. Muduli, D. Majhi and S. Ayyappan, 2000c. A preliminary study on the oxygen consumption of table fishes during transportation. *The Fifth Indian Fisheries Forum*, 17-20 January, 2000, CIFA, Bhubaneswar, India, p. 83.
- Aravindakshan, P.K., Bikash Sarkar, S.K. Singh, D. Majhi and S. Ayyappan, 2000d. Design and fabrication of FRP Aqua filter for aquaria. *The Fifth Indian Fisheries Forum*, 17-20 January, 2000, CIFA, Bhubaneswar, India, p. 133.
- Aravindakshan, P.K., Bikash Sarkar, S.K. Singh and D. Majhi, 2001. Analysis of manufacturing cost for factory production of portable FRP carp hatchery." in *National Symposium on Fisheries Technologies and their Commercialization*. 11-12 January, 2001. CIFE, Mumbai, India.
- Bandyopadhyay, M.K., S.D. Tripathi, P.K. Aravindakshan, S.K. Singh, Bikash Sarkar, D. Majhi and S. Ayyappan, 2000. Fish culture in polyhouse ponds- A new approach for increasing fish production in low temperature areas. Abstract. *The Fifth Indian Fisheries Forum*, 17-20 January, 2000, CIFA Bhubaneswar, India, p. 7.
- Bandyopadhyay, M.K and Bikash Sarkar, 1991a. Construction of fibreglass reinforced plastic major carp hatchery. National Workshop on *Aquaculture Economics*, Asian Fisheries Society (Indian Branch), 20-22 Nov, 1991. CIFA, Bhubaneswar, India
- Bandyopadhyay, M.K., S.K. Singh and Bikash Sarkar, 1991b. Growth and production of *Ctenopharyngodon idella* reard in the plastic cage. *National Symposium on New Horizons in Freshwater Aquaculture* 23-25 January, 1991. CIFA, Bhubaneswar. India
- FAO, 1999. Rural Aquaculture in India. *RAP publication 1999/21. Food and Agriculture Organization*. Regional Office for Asia and Pacific. Thailand. Bankok
- Mohapatra, B.C., S.K. Singh, Bikash Sarkar, D. Majhi, C. Moharathi and K.C. Pani, 2002. Common carp, *Cyprinus carpio* (L.) seed rearing in polyhouse pond environment during low temperature periods. *The Sixth Indian Fisheries Forum*, 17-20 December, 2002, CIFE, Mumbai, India, AQ- 4: 4.
- Mohapatra, B.C., Bikash Sarkar and S.K. Singh, 2003. Use of plastics in aquaculture. In: Satapathy, K. K. and Ashwani Kumar (Ed.) *Plasticulture intervention for agriculture development in North Eastern Region*. ICAR Research Complex for NEH Region, Umiam, Meghalaya: pp 290-305.

- Mohapatra, B.C., S.K. Singh, Bikash Sarkar and D. Majhi, 2004. Portable carp hatchery for carp seed production. In: *Technologies on Livestock and Fisheries for Poverty Alleviation in SAARC Countries*. SAARC Agricultural Information Centre, Dhaka: pp 132-135.
- Mohapatra, B.C., S.K. Singh, Bikash Sarkar and N. Sarangi, 2005. Portable FRP carp hatchery: An aid for rural aquaculture. *Proceedings International Conference on Plasticulture and Precision Farming, November 17-21, 2005, New Delhi, India*: pp 515-522.
- Mohapatra, B.C., Bikash Sarkar and N. Sarangi, 2008. Portable FRP carp hatchery technology: Successful adoption in India. *Fishing Chimes*, **28** (4): 48-52.
- Mohapatra, B. C., Bikash Sarkar, K. K. Sharma and D. Majhi 2009. Development and testing of demand feeder for carp feeding in outdoor culture system. *Agricultural Engineering International: the CIGR Ejournal*,. Vol **XI**: 2009.
- UNO, 2009. *World Population Prospects: The 2008 Revision*. Population Division of the Department of Economic and Social Affairs of the United Nations Secretariat. June 2009.

INTRODUCTION TO USABLE PLASTICS : AN OVERVIEW

Bikash Sarkar

Plastics are perhaps the most versatile of the materials known to us. These being synthetic can be tailor made to meet the very specific performance requirements of the end-use. By virtue of their versatility, plastics are fast replacing the conventional materials such as wood, glass, metals, papers, etc. in many sectors like agriculture, irrigation, water management, aquaculture, packaging, etc. The use of plastics in agriculture/ aquaculture in the country has increased rapidly, and has acquired substantial significance in the conversion of material and energy, contributing greatly to the increased production of agricultural produce. Population of India is growing by almost 16 million a year. There is no doubt that plastics will play a major role in all sectors of human society in the coming years. It is not just the population explosion, which will lead to influence demand, but the fact that it will increase because of urbanization, phenomenal changes taking place in the Indian economy and the rise in consumerism.

The per capita consumption of plastic in the country stood at 6 kg now. By 2012, India is also projected to be the third largest consumer market for plastic goods with a consumption of 12.5 million tonnes per annum, behind US and China. While the consumption of plastics in US is projected at 38.9 million tonnes per annum, China will be neck to neck with US at 38.8 million tonnes per annum." India's consumption of plastics will grow from 7.5 million tonnes to 15 million tonnes by 2015 and is set to be the third largest consumer of plastics in the world

The increasing quantities of plastics waste and their effective and safe disposal has become a matter of public concern. The increasingly visible consequences of indiscriminate littering of plastic wastes (in particular plastic packaging wastes and discarded bags) has stimulated public outcry and shaped policy. Littering also results in secondary problems such as drains becoming clogged and animal health problems (both domesticated and wild).

2.1. Why Plastics

- Plastics are the lightest (*e.g.*, density as low as 0.55 g/cc for foam) among the materials commonly used.
- Being synthetic materials, plastics can be tailor-made to meet the exact performance requirements of any end products.

- Plastics are available from glass clear transparent to any colours- opaque and metallic, etc.
- Plastics can be co-processed, blended, compounded, etc. to improve mechanical and physical properties.
- Plastics require the least energy for conversion from raw to finished products.
- Plastic products can be produced with close dimensional tolerances from the first piece to say the millionth piece.
- They are very easy to recycle and reuse.
- Plastics waste can be incinerated to produce energy.
- Around 7% of the oil explored is used for producing the total quantity of plastics globally.

2.2. Thermoplastic and Thermosetting Plastics

Plastics can be subdivided into two large categories: thermoplastic and thermosetting. The former term refers to a material that can be melted and shaped over and over again. Examples of thermoplastics include acetal, acrylic, cellulose acetate, polyethylene, polystyrene, vinyl and nylon. A thermosetting plastic, in contrast, can be melted and shaped only once. If it is then heated a second time, it tends to crack or disintegrate. Examples of thermosetting plastics (or just thermosets) include amino, epoxy, phenolic and unsaturated polyesters.

2.2.1. Thermoplastic

A polymer that softens when heated and that returns to its original condition when cooled to ordinary temperatures.

Types of Thermoplastics

- Acrylonitrile butadiene styrene (ABS)
- Acrylic (PMMA)
- Cellulose acetate (CA)
- Ethylene-Vinyl Acetate (EVA)
- Fluoroplastics (PTFE, alongside with FEP, PFA, CTFE, ECTFE, ETFE)
- Polyacetal (POM or Acetal)
- Polymethyl methacrylate (PMMA)
- Polyamide (PA or Nylon)
- Polyethylene terephthalate (PET)
- Polycarbonate (PC)
- Polyester

- Polyethylene (PE)
- Polyimide (PI)
- Polypropylene (PP)
- Polystyrene (GPPS/HIPS)
- Polyurethane (PU)
- Polyvinyl acetate (PVA)
- Polyvinyl chloride (PVC)
- Styrene-acrylonitrile (SAN)
- Low density polyethylene (LDPE)
- High density polyethylene (HDPE)
- Celluloses (CA, CAB, CP)
- Saturated polyester

2.2.2. Thermosetting Plastic (or Thermosets)

A polymer that solidifies when heated and that cannot be melted a second time. Thermoset materials are generally stronger than thermoplastic materials due to this 3-D network of bonds, and are also better suited to high-temperature applications up to the decomposition temperature.

Types of Thermosetting

- Unsaturated polyester
- Phenol formaldehyde (PF)
- Urea formaldehyde (UF)
- Melamine formaldehyde (MF)
- Epoxy
- Vinyl ester (VE)
- Silicons
- Polybutadiene
- Furans and
- Polyurethane

Some examples of thermosets are:

- Polyester fiberglass systems: (SMC Sheet molding compounds and BMC Bulk molding compounds)
- Bakelite, a phenol-formaldehyde resin (used in electrical insulators and plasticware)

- Duroplast, similar to Bakelite
- Urea formaldehyde foam (used in Plywood, particleboard and medium-density fibreboard)
- Melamine resin (used on worktop surfaces)
- Epoxy resin (used as an adhesive and in fibre reinforced plastics such as glass reinforced plastic and graphite reinforced plastic)
- Polyamides (used in printed circuit boards and in body parts of modern airplanes)

2.3. Most Commonly Used Plastics in Aquaculture

- **PVC:** Pipe and fittings, aeration pipeline, hosepipes and fittings, valves, cage floats, cage structure, drums, jeri-cans , prawn shelter, fish handling crates, etc.
- **HDPE (Hi-density Polyethylene):** Floats for cages, twines and ropes, net webbing, monofilament for making nets and hapas, storage tanks, Pipes and fittings for water supply, aeration, drainage, pools for water holding, Tubs, buckets, trays, basins, and different components of aquaculture implements, laboratory wares
- **PP:** Twines and rope, crates, Tubs, buckets, trays, basins, laboratory wares
- **Nylon:** Twine and ropes, fish nets, components for implements
- **LDPE:** Pond lining, greenhouse canopy cover,, fish seed transportation carry bags
- **FRP or Composite:** Boats, floats, plastic gadgets, live fish transportation tank, carp hatchery, fish feeding device, magur hatchery
- **Acrylic (PMMA):** Glass Jar hatchery, small container

2.4. How to Select the Plastics

- First examine the material and cutting test to determine, whether it is Thermoplastics or Thermosetting.
 - If a shaving can be pared off with a knife, it is probably thermoplastics
 - If the material is rigid and will not pare but instead, flakes or powders, it is probably thermosetting.
- PMMA and polystyrene are difficult to pare.
- An electric soldering iron is a good tool to use for identification. Before it get red hot, press it against the unknown samples. If it sinks the sample is thermoplastics and if not sinks it is Thermosetting.
- Floating test in water
 - Sinks: Nylon, Polycarbonate, PF, UF, etc.
 - Floats: LDPE, HDPE or PP

- v) Observe colour
- Black or brown: Probably PF
 - Light or pastel colour: Probably UF or MF
- vi) Dropping test on hard surface
- Metallic ring: PC, PS, SAN or ABS
 - Dull sound: CA, PVC, Nylon, PTFE, PMMA and Acetal resin
- vii) Scratch test: (Surface finish try to scratch with finger nail)
- Low gloss easily scratched: probably LDPE
 - High gloss can be scratched: Probably HDPE
 - High gloss can not be scratched: Probably PP

2.4.1. Specific Gravity Test in Water

Floats on water (SG < 1)	Specific gravity	Sinks in water, (Floats in HYPO)	Specific gravity	Sinks in HYPO	Specific gravity
Polypropylene	0.90	Polyethylene oxide	1.06	CAB	1.20
LDPE	0.92	Polystyrene	1.07	PC	1.20
HDPE	0.96	SAN	1.10	PMMA	1.20
Ethylene vinyl acetate copolymer	0.93	ABS	1.10	Polysulphone	1.24
		Nylon	1.10	PP	1.30
				CA	1.30
				Cellulose Nitrate	1.37
				PVC	1.40
				Polyamides	1.40
				Acetal resin	1.40
				PTFE	2.75
				PF	1.42
				MF	1.48
				UF	1.501

2.4.2. Burning Test

Plastic material	Colour of flame	Kind of smoke	Other features
Polyethylene	Blue with yellow tip	Almost absent	Flaming plastics tends to drip off
Polypropylene	Yellow with blue base	-do-	-do-
PTFE	Not burn	None	None
Polystyrene	Orange-yellow	Heavy, black sooty	Spurting, burn readily
ABS	-do-	-do-	Strong smell of styrene and rubber
PVC	Yellow with green at bottom edges	Some white smoke	Burns with difficulty self-extinguishing
Cellulose Nitrate	Hot, white	None	Burns furiously, very dangerous
CAB	Yellow	Some light smoke	May be spurting
PMMA	Blue and yellow flame clear tipped, bubbles at base	A little black smoke	Spurting, not self-extinguishing
Nylon	Blue with yellow tip	None	Charring observed and material drips flame tends to go out self-extinguishing
Acetal resin	Pale blue	None	Burns readily
Polycarbonate	yellow	Smoky	Self-extinguishing (Phenol based)
PET	Yellow	Slightly smoky	-
Polyvinyl acetate	Dark yellow	Sooty	-
Thermosets			
Phenol resin	Yellow	None, Some sparks	Self-extinguishing, swells and cracks
Urea resin	Yellow with a light blue edge	None	Flame tends to go out, swell and cracks, white when burnt self-extinguishing
Melamine resin	Pale yellow light blue edge	None	Burns with difficulty, swells and cracks, self-extinguishing
Epoxy	Yellow	Smoky	-

2.5. Conclusion

India's plastic consumption is currently about 6 kg/capita, compared with the world average of 20 kg/capita. The use of plastics in aquaculture and fisheries is very limited in India. In general, plastics are in use for packaging of processed fish, making of crafts and gears, etc. For effective utilization of plastics in agriculture in India, during 1988, ICAR has launched an All India Co-ordinate Research Project on "Application of Plastics in Agriculture". Under this project a Co-operating Centre on Use of Plastics in Aquaculture was established at Central Institute of Freshwater Aquaculture, Bhubaneswar.

References

- APME (Association of Plastics Manufacturers in Europe), 2000. Plastics: An analysis of plastics consumption and recovery in Western Europe, 1998. Brussels, Belgium: APME; 2000.
- Athalye, A.S., 2002. Use of plastics as alternative materials, *Popular Plastics and Packaging*, January 2002 (81-87).
- Business Standard Reporter / Kolkata/ Bhubaneswar, January 13 2009.
- <http://www.plastindia.org>
- Kushreshtha, A.K. and S.K. Awasthi, 2000. The present status of the Indian plastics industry and its future developments: *Popular Plastics and Packaging. Plastindia Exhibition Special Issue*, 2000 (29-60).
- Nayak, S.K., S.N. Yadav and S. Mohanty, 2010. *Fundamentals of Plastics Testing*. Springer (India) Private Limited, New Delhi (1-421).
- Plast India, 2009. *7th International Plastics Exhibition and Conference*. Venue: Pragati Maidan, New Delhi, February 4 - 9, 2009.
- Shastry, H.V., 1989. Identification and selection of plastics for product development. *Training Manual, CIPET, Bhubaneswar Centre*, 1989.
- Wikipedia, the free encyclopedia.

FABRICATION TECHNIQUES OF FIBRE REINFORCED PLASTICS

Bikash Sarkar, Dukhia Majhi and B.C. Mohapatra

Glass Fibre Reinforced Plastic (GRP) has emerged as one of the important class of construction material for making load bearing structures and products. Several products are being made out of these materials and the applications are spread in almost all fields of engineering. A thorough understanding of the materials and their property are essential for their effective utilization. Over the years several new materials have been developed by man for his technological needs and comforts. As the technology became more and more sophisticated, correspondingly the materials used also have to be made more efficient. The conventional materials may not always be capable of meeting the demands. New materials are being created for meeting these performance requirements. The glass-reinforced plastic (GRP) otherwise known as FRP is one class of such materials developed for the modern technological applications. The percapita composite consumption in different countries is as follows.

Countries	Overhead composite consumption
India	0.09 kg
China	0.8 kg
USA	7.0 kg

The per capita consumption of fibre-reinforced plastics in India is very small in comparison to the consumption in other countries. There is abundant scope for the growth of this sector. All the resins are locally manufactured.

3.1. Glass Fibre Reinforced Thermoset Plastic

Thermosets are cross-linked polymers, which cannot be reshaped or reworked subsequently. They are initially available in linear polymer form, which can be cross linked using heat and/or catalyst. Unsaturated Polyester, Phenolics, Epoxies, Furan, Amino resins, Polyamides, Melamine, Polyurethane, Silicones, etc. are the thermoset resins used for making GRP. Out of these resins, polyesters and epoxies that account for the bulk of the composite. Composite materials are made up of by combining two or more materials in such a way that the resulting material has certain desired or improved properties. The example is the Glass Reinforced Plastics (GRP).

Composite materials are made out of glass fibre and thermosets by 18 different processing methods. These methods give a wide range of material structure and help

to make products of different complexities. The properties of the composites made by these manufacturing methods also differ considerably. The choice of a particular composition of GRP and the manufacturing methods depend on the type of product and the property requirements. Composites have several properties and features that make them to stand above all other conventional materials both in their performance efficiency and manufacturing adaptability. Some of these attributes are given below:

- Fibrous composites have generally high specific strength and specific modulus.
- Composites are multifunctional materials.
- Composites are generally energy efficient.
- Composites generally can be made corrosion resistant and weather resistant.
- The composites can be designed to give properties for specific design conditions.
- By proper orientation of fibres, directional properties can be obtained.
- Products of complex shapes can be easily molded without any material wastage.

3.2. Basic Features of GRP Product Design

Design of GRP product differs in two respects from the design of products made out of other conventional materials. In the case of conventional product design, ready-made materials like steel, aluminum, timber, etc are used. The materials generally do not undergo any chemical changes during the product manufacture. In the case of thermoset matrix GRP, the geometrical arrangement of fibres is being made during the product manufacture and resin generally undergoes chemical changes.

The second feature of GRP product design is the role played by the material design as a part of the overall design. Since the material can be designed to have combination of properties required for specific design situations, material design brings considerable freedom and efficiency in the product design.

3.2.1. Material Considerations in the Design Selection

The First step in a designing process is the selection of a set of design parameter, which can be listed as follow:

- Overall shape, sizes and dimensions of the product
- Selection of raw materials likes fibre, resin, filler, etc.
- Selection of the structural concepts like beams, un-stiffened panels, stiffened panels, sandwiches, panels, etc.
- Selection of the material microstructure
- Selection of interconnection of various structural elements and support arrangements.
- Selection of the processing/ fabrication / erection method
- Selection of finish, color, texture, fittings and accessories, etc.

3.3. Basic Tools Used

Some of the basic workshop tools used during building of any FRP products are as follows.

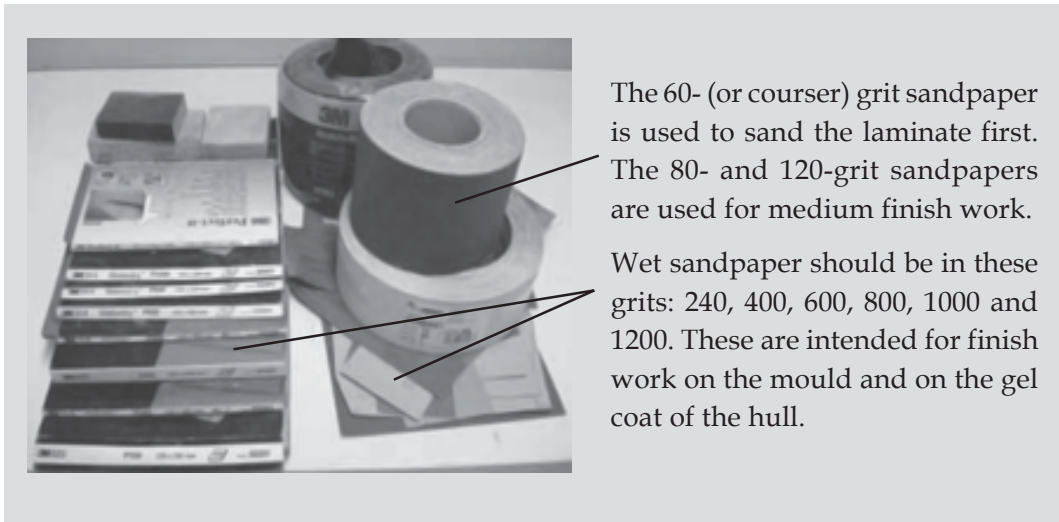
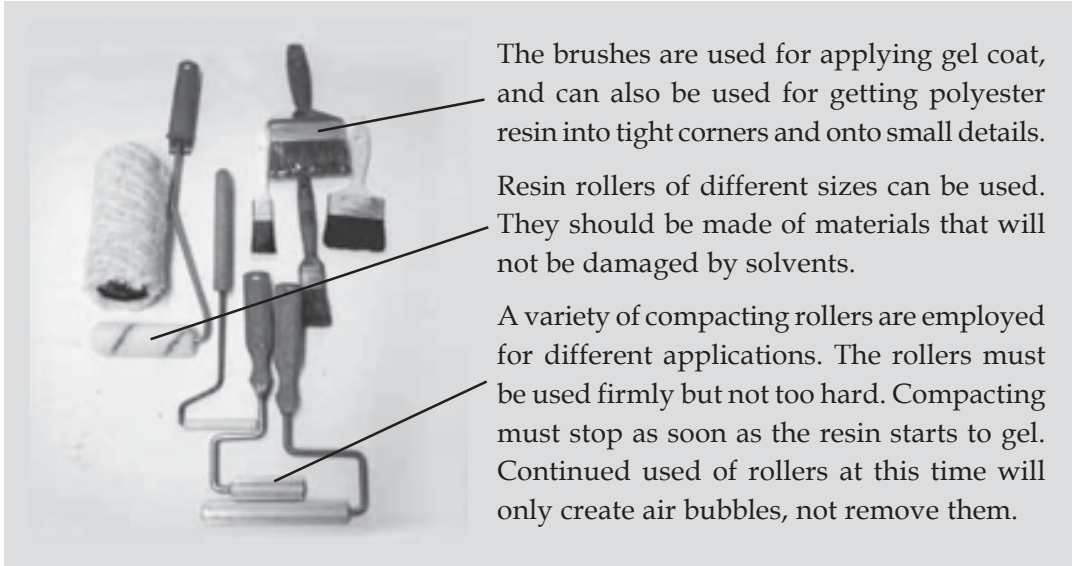

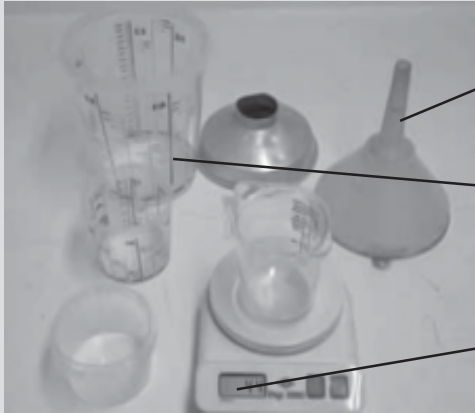

Funnels are handy for pouring polyester safely into smaller containers when larger buckets are not being used.

Transparent measuring containers of several sizes are useful for measuring polyester and gel coat.

A weight scale is an alternative for measuring small amounts of gel coat and polyester, and also for weighing fibreglass.

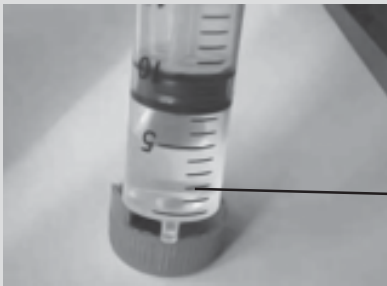

A variety of syringes can be used for correctly measuring very small amounts of hardener.

A typical cap from a soda bottle can usually hold around 5 ml of hardener.

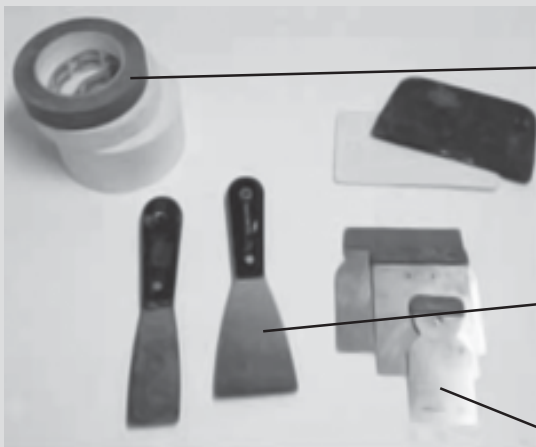

Two sizes of masking tape are used for a variety of tasks. For example, it can be used to keep two different colours of gel coat separate on the hull during construction or when isolating an area for repair operations. The tape is also handy for securing a plastic cover used for protection against dust or rain.

Scrapers with handles are used for spreading putty.

The wider, soft steel trowels typically used for bodywork on cars can also work well for this purpose.

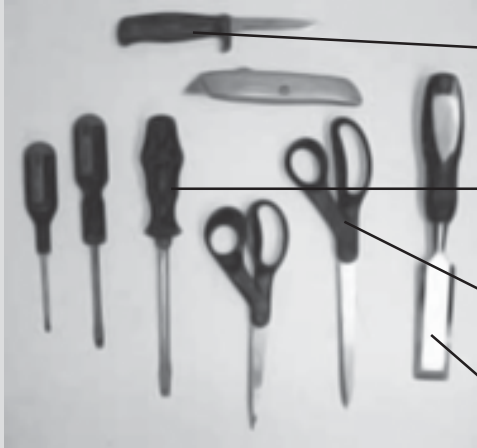

A regular knife or utility-type knife with extra blades can be used for cutting dry reinforcement (CSM) or "soft" laminate from edges.

Screw drivers are needed for mounting stainless steel cleats and drain plugs.

CSM can also be cut with scissors or torn gently by hand.

A wood chisel is handy for removing bumps and cured strands of fibreglass.

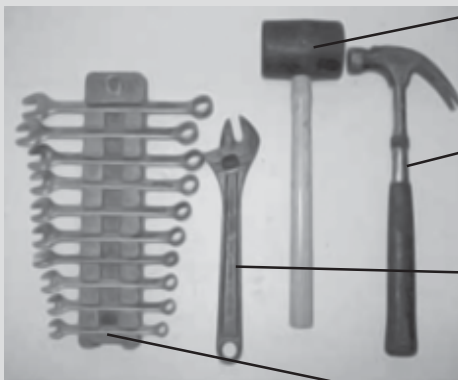

Rubber mallets are useful for careful tapping of moulds to help with demoulding.

A regular hammer is more useful for driving in wooden wedges inserted around the edge of the mould.

Combination wrenches are used for mounting bolts and nuts on the fender and with cleats, eye bolts and u-bolts.

A spanner (adjustable wrench) is also handy for holding bolts and nuts during tightening.

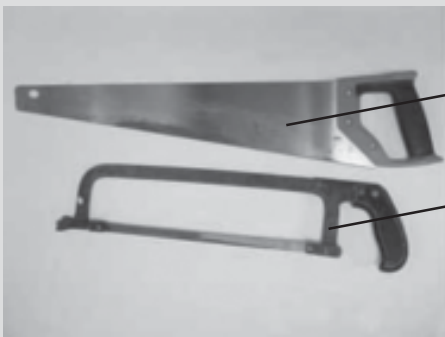

A wood saw can be used for cutting foam.

A hack-saw can be used for cutting both cured laminate and stainless steel bolts.



An electric drill should be available with a full set of twist bits.

Flat wood bits of different sizes for countersinking the 6 mm bolts for wooden fenders.

Hard metal hole saw attachments are used with the electric drill for making larger holes in the FRP laminate.



Electric disc grinders are mainly used for sanding away damaged FRP, but also for abrading the laminate prior to assembly and to improve secondary bonding. They can be fitted with rubber backing discs for use with 40-grit sandpaper.

Carborundum cutting and grinding discs can be attached and used for cutting or grinding cured laminate and cutting off stainless steel bolts.

The machine at the right of the exhibit is excellent for flattening large areas.



Belt sanders are excellent for sanding in preparation for repairs and for getting into tight corners.



A power saw with a laminated hard metal blade, like the one shown here, is useful for cutting both wood and FRP laminate.

3.4. Process Description (Hand-Lay up/ Contact Molding)

This is the most popular method of manufacturing of large and complex items. It requires minimum equipment and inexpensive moulds. Moulds are made of reinforced plastics, plaster of Paris, wood, etc. Only one mould, male or female is used and the articles produces have finish on the side that comes in contact with the mould. Resins used are of polyester and epoxy. Resin is mixed with a catalyst or hardener if working with epoxy; otherwise it will not cure (harden) for days/ weeks. Next, the mould is wetted out with the mixture. The sheets of fiberglass are placed over the mould and rolled down into the mould using steel rollers. The material must be securely attached to the mould; air must not be trapped in between the fiberglass and the mould. Additional resin is applied and possibly additional sheet of fiberglass. Rollers are used to make sure the resin is between all the layers, the glass is wetted throughout the entire thickness of the laminate, and air pockets are removed. The work must be done quickly enough to complete the job before the resin starts to cure. Various curing times can be achieved by altering the amount of catalyst employed. The lay-up normally cures at room temperature. The schematic of the lay-up process is given in Fig. 3.1.

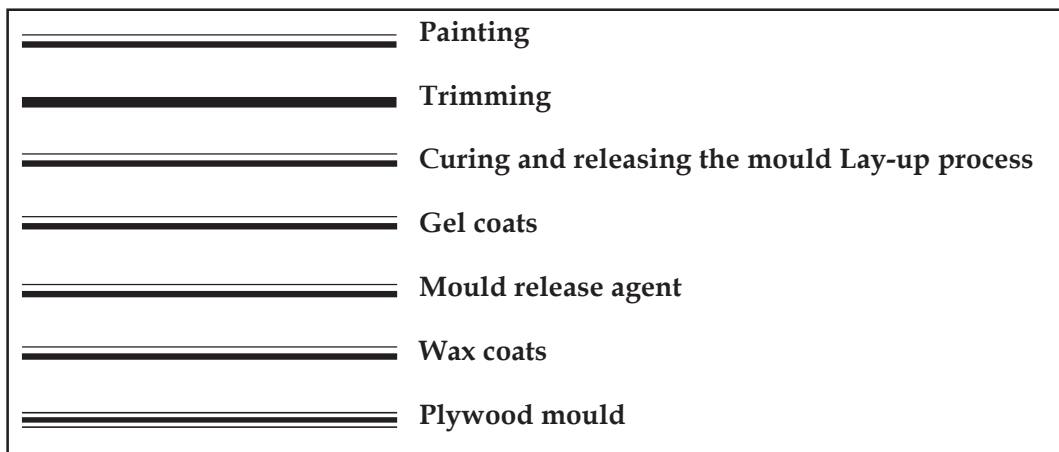

Fig. 3.1. Lay-up process of Fibre Reinforced Plastics

3.4.1. Selection of Hand Lay-up as a Fabrication Process

- When only one side smooth finish is required.
- Slight thickness variation is permissible
- Labour charges are not prohibitively high
- When the product is large in size and very complex in shape
- When only few numbers of moldings are required and the number of molding does not justify the use of costly metal dies and press molding.

3.4.2. Advantages of Hand Lay-up Process

- This method is largely used in FRP industry for boat manufacturing, automotive components, corrugated and flat sheets, tanks, etc.
- No costly machinery is required, and tools like plain brushes and rollers, and accessories like mug, knives, disc sander, hand tools and drill are used.
- Colors and decorative finishing can be obtained to individual liking and this flexibility ensured a large market for hand lay-up products.
- Hand lay-up method requires comparatively a very low investment of capital and is ideally suited for small fabrication unit. Today hand lay-up is most popular method in India and practically every FRP fabricator is equipped with the lay-up process.

3.4.3. Limitations

- This technique is labour intensive and quality of the product depends largely on one finished surface and is unsuitable if finish is required on both surfaces.
- For mass productions, normally it cannot compete with press molding.
- Thickness cannot be controlled with any degree of accuracy.
- It is difficult to obtain uniform glass to resin ratio.

3.5. GRP/ FRP Making

Step-1: Design of Mould

Mould is the prime requirement for making any FRP product. A suitable mould must be made before any molding process is undertaken. This is one of the most important steps, since it affects the quality of the molding. When wide ranges of possible molding processes are available, many different types of moulds are required. This can be made from wide varieties of materials including wood, plaster of Paris, concrete, sheet metal, epoxide, polyester resins, non-ferrous metals and steel or a combination of these factors, which affect choice of mould materials, include the number and size of the moldings

to be produced, the type and finish required and the molding process. While designing the mould, several parameters like material selection, mould thickness, mould trim line size, mould taper, etc. are to be considered.



Mould for hatchery unit

Step -2: Construction of Mould

Open mould processes of FRP fabrication make use of only the male or female half of the mould. Since pressure is not applied in hand lay-up or spray-up methods, the moulds need not be as strong as the moulds used in compression molding. Also, when heating is not required metallic moulds are not essential. Wooden mould requires finishing work on moulds after every cycle of molding. FRP moulds are ideal for intricate shapes. When heating or pressing is required the metallic mould has to be coated with wax and releasing agent. For trimming some allowances may be allowed, which is slightly larger than the product dimensions.

Step - 3: Seal the Mould

The mould must be sealed to keep the resin from sticking on to it. Sealers also tend to make the mould surface smoother. Mould sealed with polyester resin is thoroughly dried. The plastic resin produces the best sealer finish. It buffed to give a higher polish on the molded laminate.

Step - 4: Wax the Mould

After the mould is properly sealed, hard paste wax is applied on it twice. A good automobile wax, one that contains Carnauba, is desirable. Polishing should be done on the mould as to an auto body, using a clean soft cloth.

Step - 5: Apply Mould Release

Mould release (PVA) is to be applied over the paste wax to make the separation of mould and product quite easy. The separation should be at the wax line, but if the

mould release is not present, the heat of cure may destroy the wax. Water-soluble film forming of paste type mould release may be used as mould releasing agent and applied with brushes/sponge. It will dry after 3-4 hours of application and form a thin plastic film, which can be removed with water.

Step - 6: Apply Get Coat of Resin

Mix the gel resin first with the colour pigments (10%) and then 1-2% accelerator (Cobalt naphthanate) is added to this mixture. Then add 2% catalyst (MEK) peroxide to it and mix again. Brush the resin mix in a thick coat on the mould surface. Allow it to cure. The first coat should be as thick as possible without severe drainage. It makes a nice surface with polish. These gel coats are allowed to cure before any other materials are added to the laminate. Sand the cured gel coat or rough lightly with steel wool before the next coat is applied to prevent the delamination.

Step - 7: Application of Resin

The resin is mixed with the normal amount of accelerator and catalyst, and applied over the cured get coat. This resin coat will hold the glass material in place, and also help to keep out air bubbles.

Step - 8: Apply First Layer of Glass Material

Cut chopped stand mat (300 g/m²) to the shape of the product (allow enough on all sides to grasp the material and pull out the wrinkles) and lay it over the mould, which has just been covered with resin. Lay it down from one side to prevent air from being trapped in it.

Step- 9: Additional Glass Material Layers

Additional layers of material (300 g/m² or 450 g/m²) either chopped stand mat or woven moving placed over the mould in the same manner as the first ones. This layer may be of different kind of material than the first. Greater strength is achieved with each additional layer. Be sure to remove all air pockets between the layers. Layers will stick well if each layer is added in the right manner.

Step - 10: Final Resin Coat

A final coat of resin with colour is added after the laminate is cured properly. This coat is needed to get a better finish on the outer side of the product.

Step -11: Curing the Laminate

The fiberglass reinforced plastic laminate is allowed to be cured until it is hard. If the laminate is removed from the mould before the plastic is cured, the layers of glass fabric may separate from each other. The usual time of curing is from 16-24 hours and it could be adjusted with catalyst concentration to reduce the curing period. In some

cases it is desirable to remove the laminate from the mould before it is completely cured, as slight flexibility of the laminate at this stage will allow easier removal/separation from the mould.

Step -12: Removal of the Product from the Mould

Remove the laminate from the mould with as much care as possible. It is easy to damage the laminate and the mould at this point. An inexpensive putty knife with the end ground well may be used for this purpose. Several thin pieces of wood may be pushed between the mould and the laminate. Water will soften the film forming mould release for easier removal. A soft mallet may be used for this purpose.

Step -13: Trim and Finish the Edges

The edges of the laminate are very rough when it is removed from the mould. The extra fabric and plastic resin dripping is removed with hand wood working or metal cutting hand tools. The trimmed edges is planned with a hand plane, filed with wood or metal files, and sanded with wet or dry sand paper. After sanding, the edges may be coated with resin. This is not always necessary, but, it improves the appearance of thicker laminates. It will seal the edges and improve the color. If the edges are not sealed, they are to be buffed.

Step -14: Strength of the Materials/ Laminates

When fiberglass materials are combined with plastic resins and the resins are cured, the greatest strength is produced. It is possible only when the correct balance is kept between the two materials. In general, the larger the volume of glass in the product the greater the strength achieved to the product.

Thickness in mm of one layer of Glass Fibre Reinforced Polyester or Epoxy Laminates

Type of mat/ cloth and density	Resin to Fibre ratio by weight				
	1.0	1.5	2.0	2.5	3.0
Chopped strand Mat	1.0	1.5	2.0	2.5	3.0
300 g / m ²	-	-	0.62	0.74	0.87
450 g / m ²	-	-	0.93	1.11	1.30
600 g / m ²	-	-	1.24	1.49	1.74
900 g / m ²	-	-	1.86	2.22	2.60

3.6. Conclusions

It is difficult to quantify the growth prospects for composites, but qualitatively it can be predicted that with increasing emphasis on strength, light weight, chemical resistance, heat resistance and corrosion resistance, etc. the demand for FRP is bound to grow significantly for such applications.

References

- Aravindakshan, P. K., Bikash Sarkar, S.K. Singh, D. Majhi and S. Ayyappan, 2000a. Fibreglass reinforced plastics open enclosure breeding system: A new approach. Abstract. *The Fifth Indian Fisheries Forum*, 17-20 January, 2000, CIFA, Bhubaneswar, India, p. 133.
- Aravindakshan, P.K., Bikash Sarkar, S.K. Singh, D. Majhi and S. Ayyappan, 2000b. FRP live fish transportation tank- An aid to freshwater aquaculture. *The Fifth Indian Fisheries Forum*, 17-20 January, 2000, CIFA, Bhubaneswar, India, p. 20.
- Bandyopadhyay, M.K. and Bikash Sarkar, 1991. Construction of fibreglass reinforced plastic major carp hatchery. National Workshop on *Aquaculture Economics*, Asian Fisheries Society (Indian Branch), 20-22 Nov, 1991. CIFA, Bhubaneswar, India.
- FAO, 2010. *Training Manual on the construction of FRP beach landing boats*, FAO, Rome (GCP/GLO/200/MUL)
- Nair, N.G., GRP- Properties and Design Considerations- Course Module 120. FRP Research Centre, IIT, Madras.
- Nair, N.G. Introduction to Composite Product Design- Course module CM 300, FRP Research Centre, IIT, Madras.
- Vivek Patel, 2009. Ample opportunities in India's FRP pipes & tanks market. *FRP Today*, 18 August 2009.

PORTABLE FRP CARP HATCHERY

B.C. Mohapatra, Bikash Sarkar, S.K. Singh,
D. Majhi and N. Sarangi

The earlier part of 20th century has witnessed the carp seed collection from Bundhs and riverine resources by adopting different devices and collection methods. In India for the first time in 1957 carps were induced bred in captivity by administering carp (fish) pituitary extract. The breeding of carps, hatching of eggs and rearing of hatchlings up to spawn stage were carried out in different rectangular hapa made up of cloth. They were fixed in the pond for clear oxygenated water. In hapa system, the entire operations were weather dependent and subject to various environmental hazards. During seventies, glass jar hatching units of various capacities were designed and made to use successfully for hatching. The system had its own drawbacks for commercial seed production. During eighties, the carp eco-hatchery technology got familiar in India. During nineties, different models of hatcheries with different materials (HDPE, PVC, LDPE liner, Ferro-cement, etc. in various shapes and sizes) came to the existence with certain degrees of success at research level, but, they could not penetrate to the grassroots levels. The AICRP on Application of Plastics in Agriculture (ICAR), Centre at CIFA, Bhubaneswar has designed and developed the complete set of hatchery system in FRP for carp fish breeding and hatchery rearing of seed (Mohapatra *et al.*, 2003; 2004; 2005 & 2008). In one operation it can produce 1.0 - 1.2 million spawn. It has several merits like: easy for transportation to different farm sites, easy installation and operation, low water consumption during fish breeding and spawn (fish seed) production, easy to repair, less space requirement for installation, less weight and durability of the product for 10-15 years. In recent times there are available several inducing agents for fish breeding. Newly developed FRP hatchery coupled with easy availability of hormonal products can change carp seed production scenario at rural front and ultimately aquaculture productivity in the 21st century in the country. In lean season the system can be used for ornamental fish rearing or common carp breeding or water storing. This hatchery can be used as a tool for fish biodiversity conservation also. The unit can be operated by unemployed youth, Gram Panchayat and Cooperative Society on self-operational / rental basis. The innovation of portable FRP carp hatchery system is adding a feather to the blue revolution in the country by producing fish seed at the farmer's field. Thus, introduction of this hatchery is reducing the transportation of stocking material from different far off places to the aqua-farm sites involving substantial cost.

4.1. System Description

The complete hatchery unit is made in four parts for easy transport, installation, dismantle and repair. They components of the hatchery are:

- Breeding/ spawning pool
- Hatching/ incubation pool
- Egg/ spawn collection chamber, and
- Overhead storage tank/ water supply system

The schematic diagram of FRP carp hatchery unit is shown in Fig. 4.1.

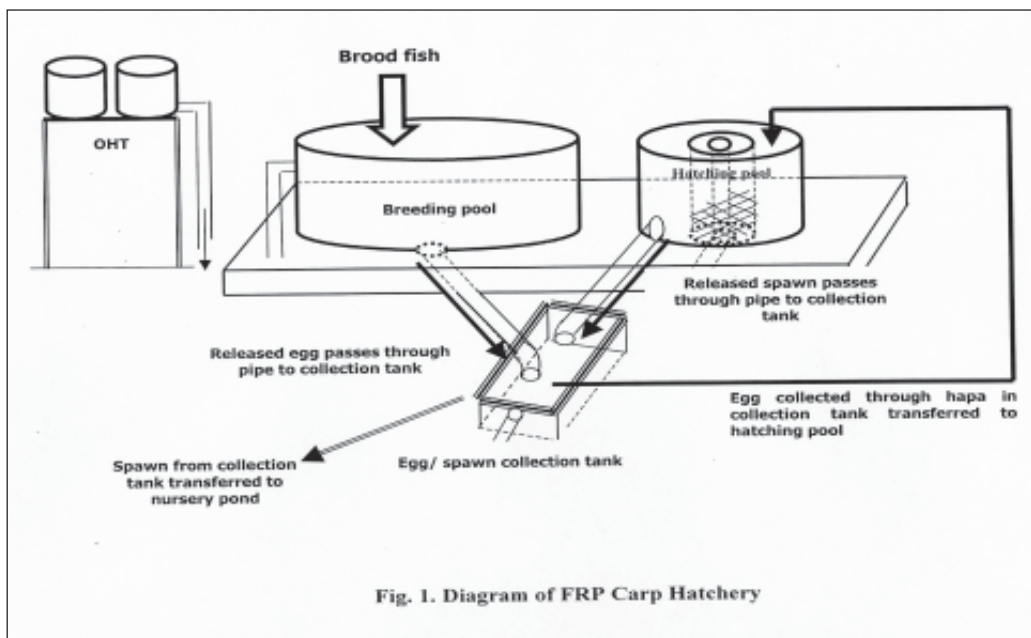

4.1.1. Breeding/ Spawning Pool

The breeding pool (Fig. 4.2.) is cylindrical in shape with 2.15 m diameter, 0.9 m height and 3409 l capacity. The bottom is with uniform slope (1:22) towards outlet at the centre. The wall thickness varies between 4.2 and 6.0 mm. To provide water circulation/flow, 5 numbers of 15 mm diameter rigid PVC elbows are fitted at the bottom of the sidewall at equal spacing. Five numbers of rigid PVC nipples 15 x 75 mm are fitted with elbows in the same direction. A single point water inlet of 25 mm diameter is also fitted at the sidewall of the bottom. All the water inlet pipes are interconnected and fitted with individual full-way valves to control the flow of water. One/two shower(s) is/are also provided at the top of the tank to sprinkle and aerate the water. The water supply to the pool comes from the overhead tank(s). If necessary the water

supply to the system can be made with an electric pump of 0.5-1.0 HP capacity. The system is suitable for breeding 10-12 kg of carps in field conditions. The breeding success has been recorded at cent percent level in various carp species. The flow rate during egg collection is maintained in the pool at 1-1.5 l/sec. depending on species.

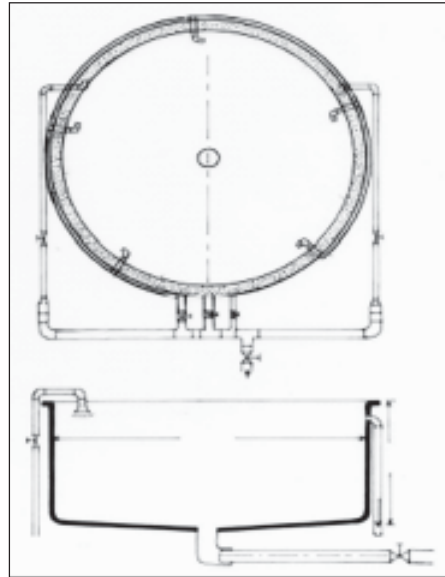

Fig. 4.2. Cross-sectional view of the FRP Breeding Pool

4.1.2. Hatching/ Incubation Pool

The pool (Fig. 4.3.) is cylindrical in shape with 1.4 m diameter, 0.98 m height and 1200 l net egg incubation volume. It consists of egg incubation chamber, FRP inner chamber, water supply system and accessories. The FRP inner chamber of the tank is with 0.4 m diameter and 89 cm height, covered with nylon bolting cloth of 0.25 mm mesh to filter the excess water to the drain. Five numbers of RPVC (15 mm diameter) duck-mouths are fitted at the bottom of the hatchery at 45° in between outer and inner chamber at equal distances to get required water flow for the eggs. It also has drainage outlets fitted at the centre and at the outer chamber for draining and cleaning purposes.

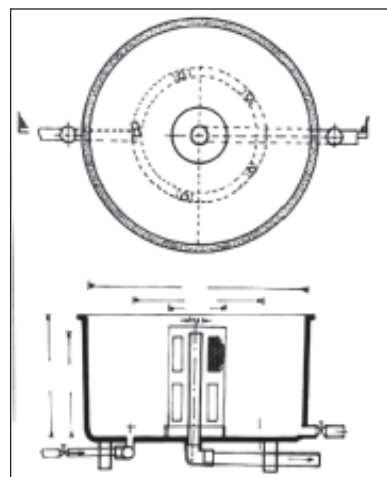

Fig. 4.3. Cross-sectional view of the FRP Hatching Pool

The carp eggs are introduced in the outer chamber of the system and water flows continuously through the duck-mouths. The excess water flows continuously through the cloth of the inner chamber to the outlet pipe. The eggs hatch out in 14-18 h and remain in the pool for 72 h. The spawn is collected from the hatching pool through PVC hose pipes/spawn collection tank. It has the capacity of hatching 1.0-1.2 million eggs per operation. The hatching percentage of the carp eggs in the system is found generally in the range of 80-95. The flow rate in the pool during operation is maintained at 0.3-0.4 l/ sec.



Fig. 4.2. Cross-sectional view of the FRP Breeding Pool



FRP hatching pool inner chamber

4.1.3. Eggs/ Spawn Collection Tank

This is a rectangular tank of size $1.0 \times 0.5 \times 0.5$ m with capacity of 250 l. Its wall thickness is 3 mm and it is reinforced with MS angle of $25 \times 25 \times 5$ mm at all sides from the bottom in a height of 0.35 m. The water level in the tank is maintained at a height of 0.45 m (net water volume 225 l). To drain the excess water, PVC pipe of 63 mm diameter and 150 mm length is fitted at a distance of 38.7 cm from the bottom. Cotton inner hapa of the tank size is fixed inside it to collect eggs/ spawn from breeding/ incubation pool, respectively.

4.1.4. Overhead Water Tank

Water storage tank of capacity 2000 l is required to operate the hatchery unit. As per the space availability, 2 tanks of 1000 l capacity each can solve the purpose. The breeding pool and hatching pool are connected to the water storage tank separately or together in the same water line. One 1.0 HP pump set is required to fill the storage tank periodically to supply water to hatchery continuously.

4.2. Site Selection for Installation of FRP Carp Hatchery

The site, which fulfills the following objectives and criteria, naturally or inexpensively, will be most suitable for installation of a hatchery.

- The water retention of the soil of the site should be very good to hold water in ponds for longer duration
- The soil preferably should be clay-loam to loam and water retention capacity more than 85%
- There should be dependable source of perennially available water in adequate quantity at the hatchery site
- There should be scope for making self draining ponds for brood and seed rearing
- The gravity flow should be utilized wherever possible to reduce pumping cost
- The physical and chemical properties of the water should be within acceptable limits
- The site should be easily accessible by road
- Building material for construction should be available nearby to reduce cost of transport
- Susceptibility of the site to flooding
- Proximity of good market for sale of seed and fish
- Availability of suitable manpower to operate the farm/ hatchery
- Availability of transport for the dispatch of fish/ seed
- Availability of electricity
- Availability of brood fishes for the hatchery
- Potential impact on neighbors and environment

4.2.1. Platform

Proper installation of the FRP hatchery unit at one place for a longer period requires a platform. The platform should be strong to withstand the pressure of the hatchery unit placed over it. The height of the platform should be such that eggs/spawn are collected in collection tanks through pipes by gravity flow only. For stability construct the periphery wall with bricks/stones masonry (1:4) from 1-2 feet below the earth surface up to 2 feet above the ground level. Fill the platform with sand up to 2 feet to give the strength. The top surface of the platform may also be provided with 4 inch concreting (1:4:8) to make more durable and strong.

The size of the platform is to be decided as per the size of the hatchery unit. It is essential to keep at least 0.5 m distances around each pool as a working space. Hence,

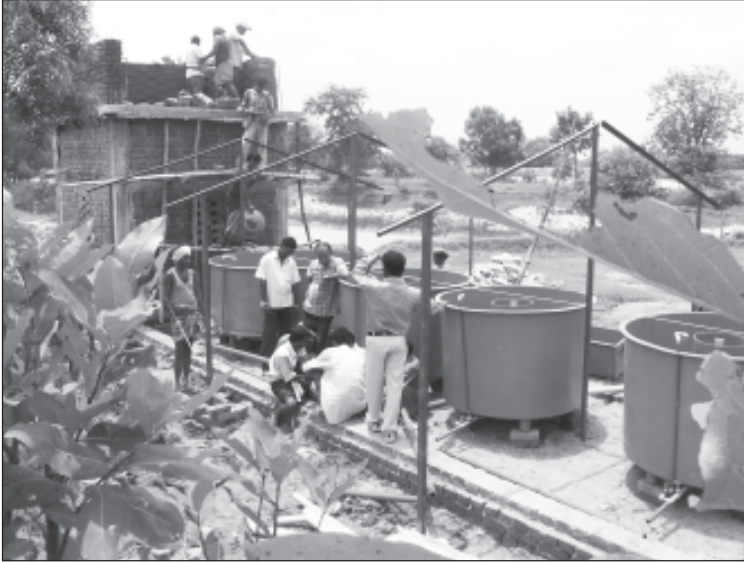

Platform and OHT

the size of the platform can easily be calculated as per the size and number of breeding and hatching pool to be kept over it. For example a hatchery unit (breeding pool 2.15 m diameter and incubation pool 1.4 m diameter) requires a platform of size 6.0 x 4.0 m.

4.2.3. Shed

A semi-open type shed of required size is to be provided for housing the breeding and incubation pools.

4.3. Carp Species Suitable for Breeding and Seed Production

The system has been designed for breeding of carps. So far all the Indian major carps *viz.*, Rohu (*Labeo rohita*), Catla (*Catla catla*), Mrigal (*Cirrhinus mrigala*), Kalbasu (*Labeo calbasu*); and three Chinese carps *viz.*, Silver carp (*Hypophthalmichthys molitrix*), Grass carp (*Ctenopharyngodon idella*), Common carp (*Cyprinus carpio*) have been successfully bred in the unit. The medium carps like *Puntius* sp. and *Labeo bata* also have been found suitable for breeding in the system.

4.4. Steps of Hatchery Operation

Clean the breeding and hatching pools by potassium permanganate (KMnO_4) solution and then by water before the hatchery operation.



Close the outlet valve of breeding pool and then fill it with water. Fix a clean cotton hapa inside it for brood fish conditioning.



Collect fish breeders male to female ratio in 1:1, transport them to breeding pool, place them in hapa and run the shower(s) for conditioning.



After 1-2 hours of conditioning, inject the breeders with suitable inducing agents and dose, release them to the breeding pool, remove the hapa, cover the pool with net clothing to prevent the escape of brood fish by jumping out from it and run the shower(s).



After 4-5 hours of injection, allow the flow/ circulation of water in the breeding pool, open the outlet valve, allow the water to pass from breeding pool through the hapa of the eggs/ spawn collection tank to the outside. If eggs released from the fishes, they are collected and removed by the hapa in the eggs/ spawn collection tank. The water current and whirling effect is created in the breeding pool by regulating the water flow through the inlets and outlet.



In hatching pool fix the FRP inner socket and then fix the screen on the socket, fix the PVC drain pipe in the center of the tank to drain excess water, the height of the drain pipe in the pool is maintained at 0.9m so that, up to that height water level can be maintained, give water circulation in the egg incubation chamber through duck-mouths (inlets).



Collect the released eggs from the egg/ spawn collection tank by hapa time to time, measure them and release to the egg incubation chamber of the hatching pool. The egg release generally stops within 8-10 hr from injection to breeders.



Remove the breeders from breeding pool once the spawning is over. They may be released to the pond after dipping them in 5 ppm KMnO_4 , clean the breeding pool by KMnO_4 solution and then by water.



On release of eggs maintain the flow rate in the hatching pool in such a way that the eggs float in the water (can be checked by putting light from a torch from the top of water), periodically check the eggs/ spawn, clean the filtering mesh by a brush with long handle from the side of inner chamber to avoid water choking.



On 4th day collect the spawn through hapa in the eggs/ spawn collection tank by opening the outlet valve connected to the outer wall of the hatching pool.



After spawn removal the hatching pool and the eggs/ spawn collection tank are cleaned by KMnO_4 solution and then by water.



To avoid direct sun light to the pools and tank, over the hatchery unit a shed may be erected.

4.5. Experimental Trials

Several experimental trials in FRP hatcheries were carried out in different locations of India with carp species for breeding and hatching of eggs (Mohapatra *et al.*, 2008). Successful seed production depends on various environmental factors *i.e.*, water temperature, dissolved oxygen, pH, water current, etc. The fish will breed, if the environmental factors are favorable to them.

As an example we report the fish breeding experiment, conducted during a cloudy period *i.e.*, 25-29 June, 2008 at West Utkal Agriculture Centre, Diptipur, Bargarh District, Odisha. Rohu, *Labeo rohita* was selected as test specimen. Five sets having average weight of 1.75 and 1.80 kg for male and females respectively were kept in the breeding pool for conditioning. The conditioning was continued for 3 hours to acclimatize the fishes to the new environment. After conditioning, breeder fishes were injected with inducing agent (Ovaprim) @ 0.2 and 0.5 ml/kg for male and female, respectively and released again to the breeding pool. The breeding response was cent percent. In total 9.50 lakhs eggs were harvested from the breeding pool. The required water flow during breeding operation is given in Table 4.1. The minimum and maximum water requirement was calculated for better understanding of the operation. The complete breeding cycle including conditioning for release of eggs took about 9-11 ½ hours. It was calculated that for 17.75 kg of fish (male: 8.75 kg + female: 9.0 kg =17.75 kg) the water requirement in breeding pool was 26.52-30.92 l/min and total water requirement was 1.59-1.85 m³/h.



Fish egg released to FRP incubation pool



Carp spawn

Table 4.1. Water requirement in FRP breeding pool

Sl. No.	Operational activity	Duration in hours	Water flow in l/min	Total water consumption (l)	
				Min	Max
1.	Initial loading of water	-	-	3409	-
2.	Conditioning of fish in the breeding pool	3.0	6.0	1080	1080
3.	Showering of water after injection of fish	4.0-5.0	5.0	1200	1500
4.	Water flow through duck-mouths	1.0 -2.0	80.0	4800	9600
5.	Egg collection	1.0- 1 ½	64.0	3840	5760
Total				14,320	21,340

After successful spawning the eggs were transferred to the hatching pool. The details of water requirement in hatching/ incubation pool are given in Table 4.2.

Table 4.2. Water requirement in FRP hatching pool

Sl. No.	Operational activity	Duration in hours	Water flow in l/min	Total water consumption (l)	
				Min	Max
1.	Initial loading of water	-	-	1200	-
2.	Initial showering and flow before eggs hatch out	12-18	28.0	20,160	30,240
3.	Water flow through duck-mouth	54-60	21.0	68,040	75,600
4.	Spawn collection	½- 1.0	21.0	630	1260
Total				90,030	1,07,100

The spawn recovered was approximately 8.50 lakh (89% of the egg production). The water requirement for operation of the hatching pool was calculated to be approximately 22.56-22.59 l/min to produce 8.50-lakh spawn from 9.50 lakh of eggs. The water requirement in hatching pool was 1.35 m³/h. In the hatchery operation, total average water requirement for both breeding and hatching of eggs was 116.39 m³. For production of one lakh spawn from the hatchery, the water requirement is calculated to be 9.58-13.28 m³.

4.6. Economics of FRP Carp Hatchery Operation

Hatchery unit of "one million spawn production per operation" consists of one breeding pool associated with one hatching pool. In this hatchery the spawn (final product from hatchery) is harvested on 4th day during operation. The fertilized eggs are kept in hatching pool for incubation and it takes 14-18 hours for hatching, and then after 72 hours for transformation to spawn. Thus, four days are required for spawn production from one million capacity unit. Similarly hatchery for "two million spawn capacity" means one breeding pool associated with two hatching pools and "three million capacity" includes one breeding pool with three hatching pools. In case of two million capacity hatchery, the eggs produced from two consecutive fish breeding operations can be incubated in two hatching pools, thus two times the seed can be harvested (totaling to two million seed production from two operations) i.e., on 4th and 5th days from initial hatchery operation. Once one hatching pool is free after harvest, the next breeding programme can be taken up. In case of three million capacity hatchery, three times the seed can be harvested (totaling to three million seed production from three operations) i.e., on 4th, 5th and 6th days from initiation of hatchery operation. Then after operations can continue with serial harvesting of spawn from hatchingpools.

Sl. No.	Items	1.0 million spawn capacity	2.0 million spawn capacity	3.0 million spawn capacity
I.	Expenditure			
A.	Fixed Capital			
1.	FRP Carp hatchery	1,00,000	1,45,000	1,90,000
2.	FRP water storage tank	15,000	22,000	30,000
3.	1 HP single phase mono block pump set (2 nos)	10,000	10,000	10,000
4.	Miscellaneous accessories	5,000	6,000	7,000
	Sub-total	1,30,000	1,63,000	2,33,000
B.	Variable Cost per Cycle			
1.	Brood fish (@ 50/kg)	1,000	2,000	3,000
2.	Electricity and fuel	200	300	400
3.	Inducing agent	325	650	975
4.	Wages (@ Rs. 100/day for 8 man-days per operation <i>i.e.</i> , 4 days)	800	800	800
5.	Miscellaneous	175	250	350
	Sub-total	2,500	4,000	5,525
C.	Total Costs			
1.	Total variable costs (20 cycles)	50,000	80,000	1,10,500
2.	Depreciation cost on fixed capital @ 10% yearly	13,000	16,300	23,300
3.	Interest on fixed capital @10% per annum	13,000	16,300	13,000
	Grand Total	76,000	1,12,600	1,46,800
II.	Gross Income (per Cycle)			
	Sale of spent brood (@ Rs. 40/kg)	600	1,200	1,800
	Sale of spawn (ave. @ Rs 600/lakh)	6,000	12,000	18,000
	Sub-total	6,600	13,200	19,800
	Gross Return (for 20 cycle)	1,32,000	2,64,000	3,96,000
III.	Net Income (Gross income - Total costs)	56,000	1,51,400	2,49,200

4.7. Conclusion

The system is so designed that it creates the environment suitable for fish breeding in the field conditions for 10-12 kg of carps in one operation. In one cycle 1.0-1.2 million spawn can be produced from the system. This much spawn in the field condition can be used as stocking material for 30 hectare of water area for biomass (fish) production.

References

- Mohapatra, B.C., B. Sarkar and S.K. Singh 2003. Use of plastics in aquaculture. In: Satapathy, K. K. and Ashwani Kumar (Ed.) *Plasticulture intervention for agriculture development in North Eastern Region*. ICAR Research Complex for NEH Region, Umiam, Meghalaya: pp 290-305.
- Mohapatra, B C., S.K. Singh, B. Sarkar and D. Majhi 2004. Portable carp hatchery for carp seed production. In: *Technologies on Livestock and Fisheries for Poverty Alleviation in SAARC Countries*. SAARC Agricultural Information Centre, Dhaka: pp 132-135.
- Mohapatra, B.C., S.K. Singh, B. Sarkar and N. Sarangi, 2005. Portable FRP carp hatchery: An aid for rural aquaculture. *Proceedings International Conference on Plasticulture and Precision Farming*, November 17-21, 2005, New Delhi, India: pp 515-522.
- Mohapatra, B.C., Bikash Sarkar and N. Sarangi, 2008. Portable FRP carp hatchery technology: Successful adoption in India. *Fishing Chimes*, 28 (4): 48-52.

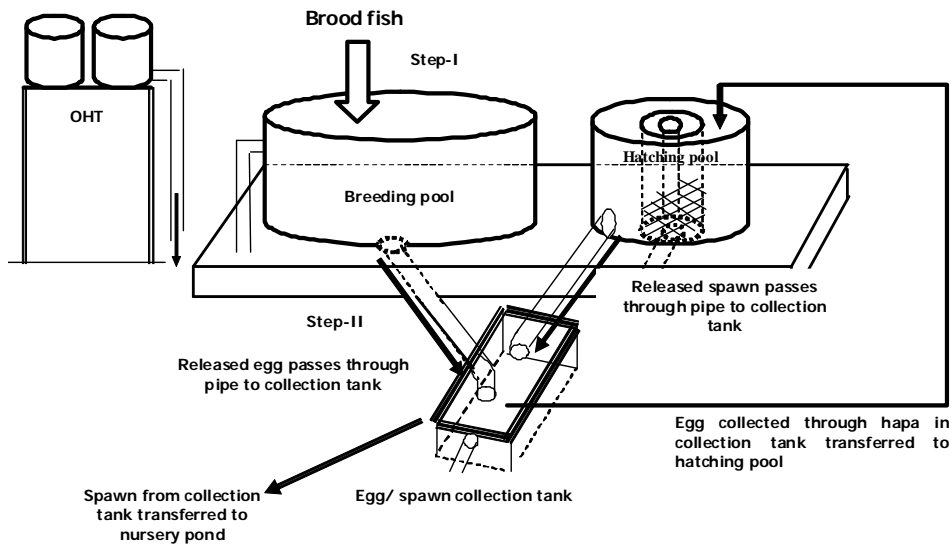

FISH REARING IN FRP SILO

B.C. Mohapatra, Bikash Sarkar, S.K. Singh, Dukhia Majhi, D. Swain and B.K. Das

There are many types of systems to grow fish. Rearing of fish in silos is a new approach (Mohapatra *et al.*, 2003; Sarangi *et al.*, 2005). It is like re-circulatory fish culture, which can hold higher biomass than traditional system per unit area. This system filters and cleans the water for recycling back through fish rearing silos. Fresh water is added to the silo tanks only to make up for water loss due to splash out and evaporation and for that used to flush out waste materials. Because this system recycles most of its water, it consumes considerable less than other types of culture systems and is well suited to areas with limited water supplies. Keeping the base as constant, the volume of the system is increased by increasing the height of the silo. This system can be located in areas where large amounts of level land are not available. The low land requirement also permits the facility to be located in areas where the soil cannot hold water or again, in urban areas, or housed in vacant warehouse buildings converted to fish farming. The system can be used in hotel industries and fast food centers for keeping fishes live for attracting and serving fish food items to tourists or customers, and also for live fish marketing. By rearing the fish indoors, the farmer is no longer limited by weather conditions where a sudden change in critical parameter can wipe out the fish stock. In this system the culturist has the opportunity to control water quality, both to the benefit of the live fish and to the final product. By maintaining dissolved oxygen at optimum levels, the fish have better food conversion and are less stressed, which translates into greater disease resistance. Having the fish indoors permits harvest at times when there exists market advantage.

5.1. Design

The system needs a continuous supply of clean water for rearing of fish. A mechanical and biological system is necessary to purify the water, and remove or detoxify harmful waste products and uneaten feed. The design will work efficiently if it accomplishes oxygenation and aeration, removal of particulate matter, biofiltration to remove waste ammonia and nitrite and buffering of water pH levels. The silos were



FRP silo

designed (Fig. 5.1.) at CIFA, Bhubaneswar for high density fish rearing (Mohapatra *et al.*, 2003).

The effluent channels of all the silos were connected to the biofilter. The filtration media were kept in five layers in the biofilter. The bottom layer (1st layer) was fitted with fine net. The second layer was filled with pebbles of size 8-16 mm and height of the layer was 20 cm. The 3rd represented the charcoal layer (these were collected from leftovers of burnt firewood). Above to this a fine net of mesh size (0.02 mm) was placed to avoid clogging from the upper layer (sand layer). The top most layer was filled with very coarse sand of size 1-2 mm. The effluent water from each silo was passed through the top layer, percolated down and stored in the filtered tank for recirculation with the help of 1HP water pump. The water of the filtered tank was pumped to the over head tank for recirculation through shower to maintain dissolved oxygen level in silo.

5.2. Fish Rearing Experiments in Silo

5.2.1. Rearing of Rohu

The silo's fish rearing experiment at CIFA was initiated with rohu, *Labeo rohita* on 17 February and was continued up to 26 March 2009. Fish (average weight 410 ± 60 g) were stocked @ 8 nos/m³ in the silos with 3, 6 and 9 m³ water volumes and 0.8, 1.6 and 2.4 m water depths respectively. Fishes were daily fed @ 3% of their body weight with pellet floating feed provided through the feeding trays. After one month of experimental trial the following results were obtained and presented in Table 5.1. In general, it was seen that the silo could be used as a holding system for short-term rearing of rohu up to 3 kg/m³. The water quality was managed in the system during the rearing period (Table 5.2.). Increasing the oxygen supply to the system and efficient biofiltering of the used water can further enhance the density, but needs experimentation.

Table 5.1. Results of rohu rearing in silo

Parameters	S-1	S-2	S-3	S-4	S-5	S-6
Effective water volume (m ³)	9.0	9.0	6.0	6.0	3.0	3.0
Water depth (m)	2.4	2.4	1.6	1.6	0.8	0.8
Stocking density (no/m ³)	8	8	8	8	8	8
No. of rohu stocked	72	72	48	48	24	24
Av. stocking size (g)	410	410	410	410	410	410
Rearing period (days)	30	30	30	30	30	30
Fish recovered (nos)	61	66	45	43	24	22
Mean size harvested (g)	449	442	450	455	461	466
Survival (%)	84.7	91.7	93.8	89.6	100	91.7

S = Silo

Table 5.2. Water quality parameters in silo during rohu rearing

Parameter	Source	S-1	S-2	S-3	S-4	S-5	S-6	Filter
D.O. (mg/l)	4.0-6.6	3.2-4.1	3.6-4.3	4.0-4.6	4.3-5.1	4.5-5.8	4.5-6.0	4.5-6.5
PH	6.8-7.5	6.1-6.9	6.3-7.2	6.5-7.6	6.2-7.3	6.6-7.4	6.8-7.4	7.0-7.4
Free CO ₂ (mg/l)	8-12	11-18	10-20	8-18	9-15	8-11	6-13	4-9
Total alkalinity (mg/l)	115-120	110-145	120-136	110-130	120-155	110-125	110-125	120-150
P ₂ O ₅ (mg/l)	0.08-0.10	0.13-0.20	0.09-0.24	0.09-0.19	0.07-0.12	0.06-0.08	0.04-0.10	0.04-0.07
NH ₄ -N (mg/l)	0.04-0.07	0.07-0.17	0.09-0.13	0.06-0.10	0.06-0.12	0.02-0.06	0.04-0.08	0.02-0.04
NO ₃ -N (mg/l)	0.08-0.16	0.09-0.13	0.05-0.11	0.05-0.08	0.02-0.04	0.01-0.05	0.01-0.03	0.01-0.03
NO ₂ -N (mg/l)	Trace	0.005-0.008	0.004-0.010	0.003-0.007	0.001-0.005	Trace-0.003	Trace-0.003	Trace
Conductivity (μmho/cm ²)	0.32	0.30	0.35	0.22	0.35	0.30	0.30	0.30

S = Silo

5.2.2. Rearing of Juvenile Rohu

Juveniles of rohu were stocked in the silos @ 2,00,000 nos/ha-m (20 nos/m³). The mean weight stocked was 122 mm/ 22.6 g in the silos with 3, 6 and 9 m³ water volumes and 0.8, 1.6 and 2.4 m water depths respectively. Fishes were daily fed @ 5% of their body weight. After five months of rearing, they grew to 70-100 g in different silos. The water parameters were monitored at regular intervals. The final data are being analyzed and given in Tables 5.3. & 5.4.

Table 5.3. Results of juvenile rohu rearing in silos

Parameter	S-1	S-2	S-3	S-4	S-5	S-6
Effective water volume (m ³)	9.0	9.0	6.0	6.0	3.0	3.0
Water depth (m)	2.4	2.4	1.6	1.6	0.8	0.8
Stocking density (nos / m ³)	20	20	20	20	20	20
No. of rohu stocked	180	180	120	120	60	60
Av. stocking size (g)	22	22	22	22	22	22
Rearing period (days)	150	150	150	150	150	150
Fish recovered (nos)	110	117	105	100	59	60
Size harvested (g)	70-80	72-76	81-86	85-90	95-100	95-100
Survival (%)	73.3	78.0	87.5	83.3	98.3	100

S = Silo

Table 5.4. Water quality parameters in silo during rohu juvenile rearing

Parameter	Source	S-1	S-2	S-3	S-4	S-5	S-6	Filter
D.O. (mg/l)	3.2-4.8	2.8-4.4	3.1-4.5	3.4-4.8	3.6-5.2	3.8-5.4	3.7-5.6	3.4-5.0
pH	7.2-7.6	7.3-7.5	7.4-7.6	7.3-7.6	7.2-7.8	7.2-7.9	7.3-7.8	7.3-7.6
Free CO ₂ (mg/l)	10-14	8-10	8-10	8-12	6-12	4-10	6-10	2-8
Total alkalinity (mg/l)	130-150	140-155	136-160	140-155	150-160	150-160	140-160	120-150
P ₂ O ₅ (mg/l)	0.04-0.1	0.03-0.12	0.09-0.14	0.07-0.1	0.07-0.12	0.03-0.08	0.02-0.10	0.02-0.07
NH ₄ -N (mg/l)	0.04-0.10	0.12-0.21	0.18-0.26	0.10-0.38	0.10-0.32	0.19-0.25	0.190-24	0.06-0.09
NO ₃ -N (mg/l)	0.01-0.03	0.10-0.15	0.06-0.16	0.06-0.12	0.08-0.10	0.07-0.11	0.07-0.13	0.01-0.04
NO ₂ -N (mg/l)	Trace	Trace-0.005	0.004-0.005	0.001-0.003	Trace-0.001	Trace-0.001	Trace-0.001	Trace
Conductivity (µ mho/cm ²)	0.32-0.348	0.33-0.349	0.31-0.348	0.32-0.348	0.33-0.348	0.30-0.345	0.30-0.350	0.26-0.347

S = Silo

Second experiment on rearing of rohu, *Labeo rohita* was conducted in the silo for four months. The juveniles of rohu were stocked @ 50,000 nos/ha (5 nos/m³). The mean weight stocked was 46.7 g in the silos with 3, 6 and 9 m³ water volumes and 0.8, 1.6 and 2.4 m water depths respectively. Fishes were daily fed @ 3% of their body weight. The results are given in Tables 5.5 & 5.6.

Table 5.5. Results of rohu juvenile rearing in silos

Parameter	S-1	S-2	S-3	S-4	S-5	S-6
Effective water volume (m ³)	9.0	9.0	6.0	6.0	3.0	3.0
Water depth (m)	2.4	2.4	1.6	1.6	0.8	0.8
Stocking density (no/m ³)	5	5	5	5	5	5
No. of rohu stocked	45	45	30	30	15	15
Av. stocking size (g)	46.7	46.7	46.7	46.7	46.7	46.7
Rearing period (days)	120	120	120	120	120	120
Fish recovered (nos)	40	38	26	27	15	15
Mean size harvested (g)	71.0	72.16	81.4	79.6	109.0	105.0
Survival (%)	88.8	84.4	86.6	90.0	100	100

Table 5.6. Water quality parameters in silo during rohu juvenile rearing

Parameter	Source	S-1	S-2	S-3	S-4	S-5	S-6	Filter
D.O. (mg/l)	4.8-5.6	4.0-4.8	3.9-4.6	4.3-4.8	4.6 - 5.2	4.6-5.0	4.5-4.6	4.8-5.4
PH	7.2-7.8	7.3-7.5	7.4-7.6	7.3-7.6	7.2-7.6	7.2-7.6	7.3-7.8	7.3-7.6
Free CO ₂ (mg/l)	10-14	4-10	6-10	8-12	6-12	4-8	6-10	2-6
Total alkalinity (mg/l)	110-130	120-140	120-136	116-140	150-156	150-152	140-152	150-156
P ₂ O ₅ (mg/l)	0.06-0.1	0.08-0.12	0.09-0.14	0.07-0.1	0.07-0.12	0.03-0.08	0.04-0.10	0.02-0.07
NH ₄ -N (mg/l)	0.03-0.07	0.07-0.12	0.08-0.13	0.06-0.1	0.06-0.08	0.03-0.06	0.02-0.08	0.02-0.04
NO ₃ -N (mg/l)	0.01-0.06	0.01-0.08	0.05-0.06	0.05-0.06	0.01-0.04	0.01-0.02	0.01-0.03	0.01-0.04
NO ₂ -N (mg/l)	Trace	Trace-0.005	0.004-0.005	0.001-0.003	Trace - 0.001	Trace-0.001	Trace-0.001	Trace
Conductivity (μ mho/cm ²)	0.22	0.33	0.31	0.32	0.33	0.30	0.30	0.26

5.2.3. Rearing of Rohu Fingerlings

Experiment on seed rearing (fingerling to juvenile) of rohu, *Labeo rohita* was conducted in the silo. Fingerlings (6.1 g/ 65-105 mm) were stocked @ 10 nos/m³ in the silos. The supplementary feed was given @ 5% of body weight. The fingerlings grew to 66.0, 58.4 and 54.3 g after eight months of rearing in the silos with 3, 6 and 9m³ water volumes with 0.8, 1.6 and 2.4 m water depths respectively. The mean survival percentage was 100, 99.2 and 93.3 in respective silos. The results are given in Table 5.7.

Table 5.7. Results of Fingerling Rearing of Rohu in Silos

Parameter	S-1	S-2	S-3	S-4	S-5	S-6
Effective water volume (m ³)	9.0	9.0	6.0	6.0	3.0	3.0
Water depth (m)	2.4	2.4	1.6	1.6	0.8	0.8
Stocking density (no/m ³)	10	10	10	10	10	10
No. of rohu stocked	90	90	60	60	30	30
Av. stocking size (g)	6.1	6.1	6.1	6.1	6.1	6.1
Rearing period (days)	240	240	240	240	240	240
Fingerlings recovered (nos)	84	86	60	59	90	90
Mean size harvested (g)	67.0	65.0	57.2	59.6	54.0	54.6
Survival (%)	95.5	94.4	100	98.33	100	100

S = Silo

5.3. Biofilter Efficiency Experiment

In silos system biological filter plays a pivotal role for reducing total ammonical nitrogen, nitrite and dissolve organic matter, and increases the nitrification rate. The concentration of the total ammonical nitrogen is the most important factor to consider the biofilter design and operation (Chen *et al.*, 2006). Recirculatory aquaculture system using biological filter is highly accepted as it maintains a superior environment for fish rearing, where water is frequently cleaned and reused. This type of system reduces the space and maintains desired water quality for maintenance of a particular fish species under various agro-climatic regions.

A study was conducted from 14 July 2008 for one week in the silo fish rearing system to find out the biological filter efficiency. The rohu biomass stocked was 3.3 kg/m³ of water in the silo. The experiment was run in duplicate. The following tables explain the water quality change over time in the silo system. (Tank S-1 & S-2 with height of 2.7 m, S-3 & S-4 with height of 1.8 m and S-5 & S-6 with height of 0.9 m; silo diameter is 2.15 m)

Table 5.8. Water quality in different silos on the day of stocking

Silo	pH	Cond. (NTU)	DO (mg/l)	Alkalinity (mg/l)	Hard ness (mg/l)	Ammonia (mg/l)	Nitrite (mg/l)	Nitrate (mg/l)
S-1	7.4	0.390	5	110	50	0.0638	0.445	0.0124
S-2	7.4	0.389	5	110	50	0.0640	0.440	0.0128
S-3	7.4	0.390	5	100	50	0.0640	0.513	0.0127
S-4	7.4	0.390	5.3	110	50	0.0638	0.513	0.0124
S-5	7.4	0.390	6	100	50	0.0627	0.513	0.0128
S-6	7.4	0.390	6	100	50	0.0628	0.510	0.0128

Table 5.9. Water quality before biofiltration in different silos after 3 days of fish stocking

Silo	pH	Cond. (NTU)	DO (mg/l)	Alkalinity (mg/l)	Hard ness (mg/l)	Ammonia (mg/l)	Nitrite (mg/l)	Nitrate (mg/l)
S-1	7.0	0.412	4.2	100	50	0.0840	0.781	0.0419
S-2	7.0	0.391	4.0	110	53	0.1301	0.803	0.0322
S-3	7.2	0.471	4.1	100	55	0.0712	0.612	0.0415
S-4	7.2	0.428	3.6	110	50	0.0612	0.672	0.0593
S-5	7.2	0.472	4.8	100	50	0.0713	0.612	0.0473
S-6	7.2	0.413	5.0	100	50	0.0718	0.637	0.0418

Water quality after bio-filtration after 3 days of fish stocking, which was recycled to silos

pH	Cond. (NTU)	DO (mg/l)	Alkalinity (mg/l)	Hard ness (mg/l)	Ammonia (mg/l)	Nitrite (mg/l)	Nitrate (mg/l)
7.1	0.316	6.3	101	50	0.0513	0.0410	0.0138

Table 5.10. Water quality before bio-filtration in different silos after 7 days of fish stocking

Silo	pH	Cond. (NTU)	DO (mg/l)	Alkalinity (mg/l)	Hard ness (mg/l)	Ammonia (mg/l)	Nitrite (mg/l)	Nitrate (mg/l)
S-1	6.7	0.463	4.0	80	50	0.1038	0.736	0.0431
S-2	6.8	0.401	3.86	90	53	0.1446	0.812	0.0378
S-3	7.0	0.406	4.0	100	55	0.0831	0.610	0.0443
S-4	7.1	0.413	4.0	110	50	0.0793	0.663	0.0596
S-5	7.0	0.469	5.0	110	50	0.0637	0.713	0.0417
S-6	7.0	0.411	5.0	115	50	0.0791	0.637	0.0389

Water quality after bio-filtration after 7 days of fish stocking, which was recycled to silos

pH	Cond. (NTU)	DO (mg/l)	Alkalinity (mg/l)	Hard ness (mg/l)	Ammonia (mg/l)	Nitrite (mg/l)	Nitrate (mg/l)
6.8	0.301	5.8	110	50	0.0816	0.0513	0.0158

After filtration the amount of the nitrogenous wastes reduced in the biofiltered water. To study the stabilization of the biofilters with same filter media as in the case of biofilter of silo, one experiment was conducted in the laboratory. It was found that the biofilter got stabilized on 21st day (Swain *et al.*,2011).

Table 5.11. Reduction of ammonia through biofiltration over time

Bio-filter	Ammonia concentration in ppm							
	Initial	After 1 hour	After 1 day	After 7 days	After 14 days	After 21 days	After 28 days	After 45 days
Set 1	2.499	2.515	1.203	0.916	0.816	0.517	0.517	0.516
Set 2	2.532	4.439	1.298	0.913	0.838	0.538	0.539	0.539
Set 3	2.594	2.583	1.387	0.871	0.830	0.612	0.612	0.610

5.4. Water Quality Monitoring

While monitoring the water quality one has to keep in mind that he is dealing with two living things, the reared species and the bacteria in the biofilter. During operation one or more water parameters may record high or low values. Correct these gradually, as a rapid change for what you perceive to be the better may be more harmful in the long run if done too quickly. Make the changes gradually giving both the biofilter and the cultured species a chance to adapt to the new conditions. The possible exception to this is low DO, if this is very low it should be raised as quickly as possible.

Temperature

Temperature is a parameter that affects the rate at which the fish metabolize feed, the saturation point of oxygen and the rate at which the biofilter functions. Rapid changes upset all of the above in the system. The actual system temperature will be determined by the species cultured, but should not vary by more than a few degrees over the course of the day. This will probably not seriously affect the cultured species, but one has to keep in mind a drop of about 10°F will reduce the biofilter capacity by 25 to 50%. The biofilter will adjust to new temperatures, but it does take time.

Dissolved oxygen

Dissolved oxygen (DO) limits the amount of feed the cultured species can metabolize, the density of the species in silo and the activities of the biofilter. Maintain the DO level at 5 ppm+. It may fall below this level occasionally, but usually this causes no harm if it persists for short periods of time and other parameters are in good order. DO depressions occur mostly in the hour after feeding and the more feed used the greater the variation. Good feeding practices of spreading the daily ration over the greatest number of feedings possible will reduce these depressions. Automatic feeders can take this concept to its ultimate level of spreading food over the longest period possible. One must also keep in mind that DO is consumed by many processes in the system other than the cultured species or biofilter, some of those are chemical, some heterotrophic bacteria and algae under low light conditions. So, all oxygen is not available to the reared fish.

CO₂

CO₂ is mostly controlled by aeration of the water and in some cases by algae. CO₂ higher than 2 ppm will cause the pH to be more acid. CO₂ values can be lowered by addition of more air stones in the culture tanks.

Ammonia

Ammonia is produced in the system by the metabolism of the fish and is also produced by the decomposition of the fish wastes and uneaten feed. This is one reason why solid wastes and uneaten feed should be removed as quickly and completely as possible. Ammonia comes in two forms NH₃ (toxic) and NH₄ (non-toxic). At pH values near neutral the percentage of toxic ammonia is very low. At pH values of 7.0 - 7.5 total ammonia values of 6 ppm seem to cause few problems, especially if oxygen is in good order. Typical systems have seemed to produce ammonia levels of 1.5 - 2.0 ppm under stable operating conditions. Ammonia produced in the system increases as the feeding rate goes up or as the protein content of the feed increases. Since as the fish grow, amount of feed into the system increases and the biofilter must be given an opportunity to adjust to these increases gradually and to be able to assimilate the additional ammonia this practice produces. As long as the amount of ammonia does not exceed the biofilter is capable of removing it.

Nitrite

Nitrite is the product of the biofilter resulting from the breakdown of ammonia. Converting nitrite to nitrate seems to be the least dependable part of the nitrification process. It seems to be easily upset by rapid changes of nearly any kind, also these bacteria seem to be easily dislodged, so swings in nitrite levels are fairly common. Nitrites are toxic because they inhibit the haemoglobin of the fish from absorbing oxygen from the water, therefore even though oxygen tests indicate that DO is in good supply, if the fish are exposed to high nitrite levels they are still oxygen starved resulting in poor growth and poor general health. Fortunately, nitrite toxicity can be counteracted by the addition of chlorides (NaCl) at the rate of 6 ppm chloride for each 1 ppm of nitrite. It may be good practice to routinely maintain chlorides at 100 - 150 ppm in the system at all times. It not only reduces the threat of nitrite toxicity, but also relieves stress, reduces fungus infections and reduces the energy required by the fish to perform active transport of materials across cell membrane.

Nitrate

Nitrate, the final product of the biofilter, does not seem to cause many problems to the fish and is mostly managed by the daily replacement of water, which is removed when cleaning tanks and evaporation. If 5 - 10% of the total water is replaced daily, it will help control nitrate levels.

Alkalinity

Alkalinity is one of the factors that is interrelated with others such pH, CO₂ and ammonia nitrification. In a functioning biofilter the bacteria remove carbonates from the water to produce bacterial mass. The energy to do this comes from nitrification, therefore, as the amount of ammonia removed by the biofilter increases the amount of alkalinity in the system will decrease. The process also produces acids, which further reduce the alkalinity of the system. If the proper alkalinity is not maintained in the system, the pH will drop due to the lack of buffering and the bacteria in the filter stop functioning due to lack of carbonates. It is to maintain alkalinity 75 - 120 ppm in the system by adding sodium bicarbonate on a daily basis. In fact the filter to handle 1.0 gram of ammonia consumes about 7.0 grams of alkalinity.

pH

The pH has already been mentioned in relation to ammonia toxicity and CO₂ concentration as well. In the system maintain pH levels to alkaline zone of 7.0 - 7.5. In near acidic water adding sodium bicarbonate and aerating to reduce CO₂ accomplish this. If nothing is done to prevent it, the system will eventually become acid. The pH should not be adjusted more than 0.5 units per day. It would save money to use agricultural sodium bicarbonate, but it is not 100% pure when calculating amounts to be added.

5.4.1. Managing the Biofilter

An aquaculturist will often explain that keeping the biofilter happy is the most important job in recirculation system. If the biofilter dies, all fish will die in a few days, and it will take weeks to recondition the filter and start again. Here the goal is to make the biofilter function as efficiently and as stable as possible, while the practice of growing fish, increasing feed, harvesting fish and adding material to the water reduces efficiency and makes the filter less stable. If the biofilter is functioning well, sudden removal of a large portion of the reared fish and thus their wastes may upset the filter as badly as rapidly increasing the feed rate. A healthy biofilter has a very thin growth of orange-brown colored bacteria on the surface of the biofilter material. A thick clump of a brown slimy material is likely to be heterotrophic bacteria and not vitrifying bacteria. These may lead to clogging of the filter and also pipes, and should be discouraged by keeping the particles of uneaten feed and wastes out of the system as much as possible. Organic material added to water is not pollution, organic material added to water too rapidly or in quantities beyond the capacity of the biofilter, natural or in the system, is pollution. One has to keep this in mind when managing the biofilter.

5.5. Conclusion

The concept of carp fish rearing in silo started at CIFA, Bhubaneswar for the first time in 2001 (Mohapatra *et al.*, 2003). It is reported that the concrete silos used for trout vary from 2 to 10 m diameter, depending on the size of the rearing species (www.lib.noaa.gov/korea/korean_aquaculture/raceway.htm). According to Timmons *et al.*, 1998, large cost savings have been achieved in the production of food fish with the use of large systems and enhanced production strategies. These trends have also included the use of large circular tanks because of their many advantages for food fish production. Circular tanks make good culture vessels because they can provide a uniform culture environment, can be operated under a wide range of rotational velocities to optimize fish health and condition, and can be used to rapidly concentrate and remove settleable solids. The flow inlet and outlet structures, and fish removal mechanism should be engineered to reduce the labor requirements of handling fish and to obtain effective tank rotational characteristics, mixing and solid flushing.

References

- Chen S, J. Ling , and J.P. Blancheton, 2006. Nitrification kinetics of biofilm as affected by water quality factors. *Aquacult. Eng.* **34**, 179–197
- Mohapatra, B.C., B. Sarkar and S.K. Singh, 2003. Use of plastics in aquaculture. In: Satapathy, K. K. and Ashwani Kumar (Ed.) *Plasticulture intervention for agriculture development in North Eastern Region*. ICAR Research Complex for NEH Region, Umiam, Meghalaya: pp 290-305.

- Sarangi, N., B.C. Mohapatra, S.K. Singh and K K. Sharma, 2005. Application of plastics in aquaculture. *Proceedings International Conference on Plasticulture and Precision Farming, November 17-21, 2005, New Delhi, India*: pp 507-514.
- Swain, D.K., B.C. Mohapatra and B.K. Das, 2011. Hydrobiological dynamics of biofilter in recirculating aquaculture system with special reference to silo. *e-Planet* (In press).
- Timmons, M.B., S.T. Summerfelt and B.J. Vinci, 1998. Review of circular tank technology and management. *Aquacultural Engineering*, **18** (1): 51-69.

POLYHOUSE PONDS FOR FISH REARING

B.C. Mohapatra, Bikash Sarkar, S.K. Singh, Dukhia Majhi and K.K. Sharma

The ambient air temperature falls to 10°C or even below in winter season in colder or hilly areas of India. Use of polyhouses for raising vegetable, floriculture crops and shelter for human beings at high altitude is a common practice in winter months. Their use in aquaculture is very recent in India. Air temperature influences the water temperature, which is the most important factor for fish growth (Brett and Groves, 1979; Corey *et al.*, 1983). Growth rate increases with increasing water temperature, but when the temperature becomes super optimal, it has a negative effect instead of a stimulatory influence (Jobling, 1993). Due to lower water temperature in the pond, the metabolic activity of fish reduces (Schaperclaus, 1961; Halver, 1972; Jhingran, 1975; Brett, 1979; Degani, 1991 and Nikitin, 1996), growth retards, mortality increases, and thereby affects the fish production per unit area in winter. Sometimes extreme months of winter season witness virtually no growth due to stoppage of food intake by fishes below 7-8°C (<http://archives.nic.in/tecnofocus/june99/high.htm>). Due to low temperature regime, breeding and rearing of fish are difficult. It is necessary to maintain the water temperature between 18.3 and 37.8°C (Jhingaran, 1975) for better fish production. Especially in carps farming the gross production may be hampered below 18.3°C water temperature. In tropical climate extension of growth period is obligatory to enhance the fish production. Several workers have reported of using passive greenhouses to increase the water temperature in cultured ponds for higher fish production (Ra'anand and Cohen, 1983; APA/CIFA, 1993-2003; CIFE, 1998-99/2001-02; Pillai *et al.*, 1999; Bandyopadhyay *et al.*, 2000; Baruah *et al.*, 2000; Kumar *et al.*, 2000; Tripathi, 2001; Mohapatra *et al.*, 2002, 2003 & 2007; Khan *et al.*, 2004; Sarkar and Tiwari, 2006; Jain, 2006). In passive system, fish pond is covered with the transparent plastic film without any auxiliary heating source. The water body heated by natural convection process and absorption of direct solar radiation. The fish culture experiments conducted in polyhouse pond environment at CIFA, Bhubaneswar are reviewed in this chapter.

6.1. Working Principle of Polyhouse

The working principle of a greenhouse/ polyhouse pond is same as any conventional type of greenhouse. During sunshine hours, total solar radiation received by the greenhouse cover is partly reflected, absorbed and transmitted inside greenhouse through walls and roofs. A large portion of transmitted radiation is absorbed by water. This is utilized in raising the water temperature. The exposed surface area of the pond

absorbs rest part of the radiation. This absorbed thermal energy is further convected, radiated and evaporated into the room air and some heat conducted into the ground, respectively. Further, there are heat transfer from greenhouse room air to canopy cover by convection radiation and evaporation, and finally thermal energy is lost to ambient air by convection and radiation.

6.2. G.I. Frame Experimental Polyhouse

In ponds to maintain high water temperature for fish growth during winter periods, two arch shaped polyhouses of 13 x 8 m each and central height of 2.5 m were constructed in east- west direction over two ponds of 11 x 7 m size with G.I. pipe and UV stabilized low-density polyethylene (LDPE) film of 200 micron thickness. The property of the film is that, it is transparent to short wave length radiation ($0.23-2.3 \mu m$) to enter inside the greenhouse and does not allow long wave radiation ($> 2.3 \mu m$) from the interior surface cover to leave outside. There were provisions of two doors fixed opposite to each other in the polyhouses for natural cooling during over heating, if any. The view of the greenhouses is shown in Fig. 6.1. The depth of water in the ponds was maintained at 1.0m. Two similar sized ponds without polythene cover were used for control experimentation.



GI framed polyhouse pond

6.3. Bamboo Framed Even-span Polyhouse

The size of experimental pond was 10 ´ 6 m with maintained water volume of 50 m³. The mean water depth was maintained at 1 m. The even span bamboo framed structures each of size 12 ´ 8 m with central height 2.7 m and lateral height 1.5 m were erected over two ponds. Over the structure 200 micron LDPE sheet was spread to give greenhouse effect in pond.

6.4. Fish Culture/ Rearing Experiments in Polyhouse Ponds

6.4.1. Monoculture of Rohu

Trial-I

Polyhouse fish pond experiment was conducted for fish growth at CIFA, Bhubaneswar (Latitude- 20°15'c, Longitude- 85°52'c, and an altitude 33 m above mean sea level) during October 1994 - March 1995. The experimental place is grouped under warm and humid climate (Bansal and Minke, 1988). The greenhouse size was 13 ´ 8 m constructed over the earthen fish pond of size 11 ´ 7 m. The experiment was conducted for a period of 180 days. Advanced fingerlings of 159 ± 4.16 mm/ 33.5 ± 3.49 g of rohu, *Labeo rohita*

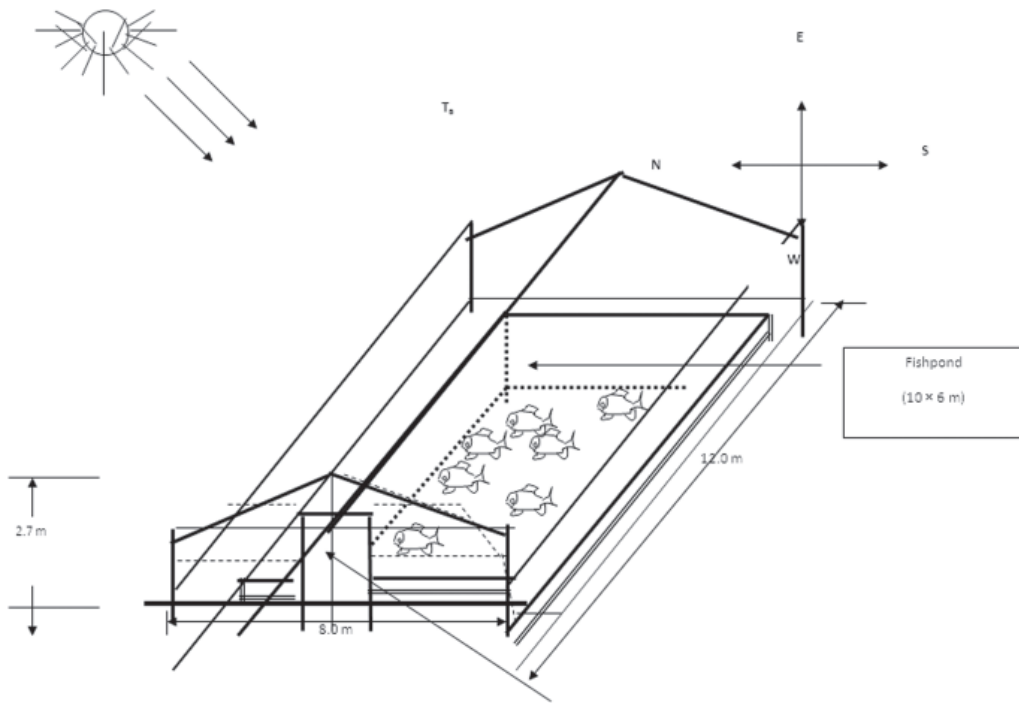

Fig. 6.1. Cross-sectional view of the bamboo framed even-span greenhouse over pond

(Ham.) were stocked @ 10,000 numbers/ha. The water levels in both the ponds were maintained at 1.0 m, compensating the loss of water due to seepage and through evaporation. Supplementary formulated feed with crude protein level of 35% was given @ 2-3% of body weight twice a day at 10:00 and 15:00 hours. The feeding quantity was adjusted at monthly intervals after estimating the biomass increase through intermittent sampling. Samplings of fishes



Bamboo framed polyhouse pond

were conducted at monthly intervals for growth and survival. Water, ambient air and greenhouse room air temperature were measured with a mercury-filled glass bulb thermometer having least count of 0.1°C. Water temperature was recorded at 8:00 and 16:00 hours. Physio-chemical parameters *e.g.*, transparency, dissolved oxygen, pH, free CO₂, total alkalinity, ammonia-N and nitrate-N were monitored at 8:00 hours fortnightly intervals following the standard methods of APHA, 1998.

Water temperature was high in greenhouse pond than the open pond throughout the experiment (Table 6.1.). The low temperature in open pond may be attributed to the

presence of higher wind velocity, lower humidity level and faster release of heat. Maximum and minimum mean water temperature $28.8 \pm 2.05^\circ\text{C}$ and $20.01 \pm 1.52^\circ\text{C}$ were observed in the month of March and January in case of greenhouse pond, while $22.12 \pm 2.13^\circ\text{C}$ and $16.20 \pm 1.42^\circ\text{C}$ were recorded in the same months respectively. The variation of water temperature in open and greenhouse pond is shown in Fig. 6.2.

Table 5.1. Results of rohu rearing in silo

The highest water temperature was found at 15:00 hours, while minimum at 5:00-7:00 hours in case of greenhouse and in case of open pond it was noticed at 14:00 and 3:00-7:00 hours, respectively. There was an increase of 3.1-5.7°C (4.21°C) water temperature in greenhouse pond as compared to open pond. The mean values of physico-chemical parameters of both the ponds are presented in Table 6.2. The chemical parameters in the water in general did not show any significant difference through-out the culture period in both the ponds, which are acceptable to fishes. Dissolved oxygen concentration showed similar pattern in both the ponds. However, dissolved oxygen level was slightly higher in greenhouse due to lowering of temperature in the greenhouse which is indicated by high densities of phytoplankton (Mohan *et al.*, 2002).

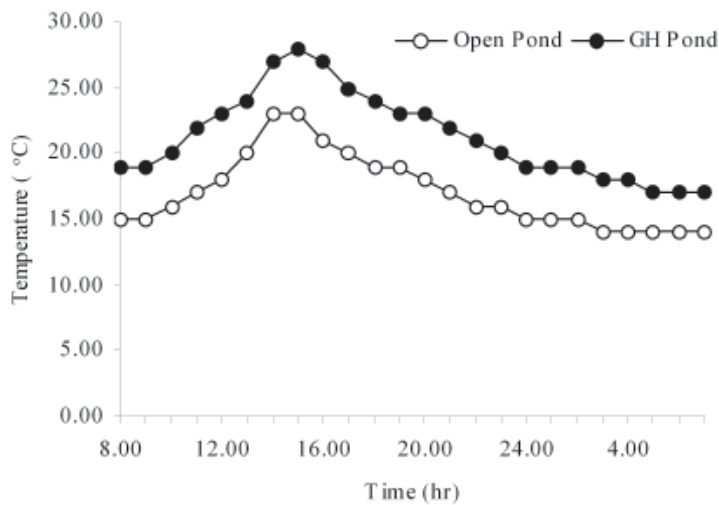

Fig. 6.2. Variation of water temperature in open and greenhouse pond on 17.01.1995

Table 6.2. Physio-chemical parameters for open and greenhouse pond

Parameters	Open ponds	Greenhouse ponds
Transparency (cm)	16.0±2.06	12.0±2.23
Dissolved oxygen (mg/l)	4.5±0.25	5.0± 0.85
Free CO ₂	5.5±1.21	6.2±1.32
pH	7.8±0.20	7.7±0.25
Total alkalinity (mg/l as CaCO ₃)	72.0±4.61	71.0±4.97
NH ₄ -N (mg/l)	0.12±0.04	0.12±0.038
NO ₃ -N (mg/l)	0.08±0.01	0.06±0.01

The mean fish growth showed higher in the greenhouse pond in comparison with the open ponds (Table 6.3.). The survival-recorded in the open and greenhouse ponds were 57.15 and 82.86%, respectively.

Table 6.3. Results of rearing experiments of rohu, *Labeo rohita* in open and greenhouse pond

Parameters		Open Pond	Greenhouse Pond
No. of fish stocked		70	70
Stocking size	Total length (mm)	159±4.16	159±4.16
	Weight (g)	33.5±3.49	33.5±3.49
Biomass (kg) stocked		2.34	2.34
No. of fish harvested (kg)		40	58
Final weight (kg)		117.5	184.5
Final biomass (kg)		4.69	9.22
Survival (%)		57.15	82.86
Production (kg/ha/crop)		657	1512.1
Gross production (kg/ha/yr)		1332.2	3066.1
Net production (kg/ha/yr)		997	2731.1
Net gain (%)		-	114.5

The mean biomass production levels were 657 and 1512 kg/ha/180 days, shown in Table 6.3. Comparing the production levels, it is observed that, higher gross and net productions of *Labeo rohita* were obtained in the greenhouse pond than in open pond. The additional biomass production was 1733.9 kg/ha/yr in the greenhouse pond than the open pond. Figure 6.3. presents the total fish weight gain for a period of 180 days rearing in open and greenhouse ponds. From the figure, it is clearly indicated that the net weight gain is higher in greenhouse, accounting to 114.5%.

Trial- II

Rohu, *Labeo rohita* was reared in greenhouse and open-air experimental ponds of size 10 ´ 6 m each at CIFA farm complex, Bhubaneswar during 2 December 2007- 10 March 2008. The ponds were stocked with 50 numbers of rohu, *Labeo rohita* (avg. wt. 75.83 ± 13.96 g and avg. length 186.1 ± 20.01 mm). Normal culture practices were followed

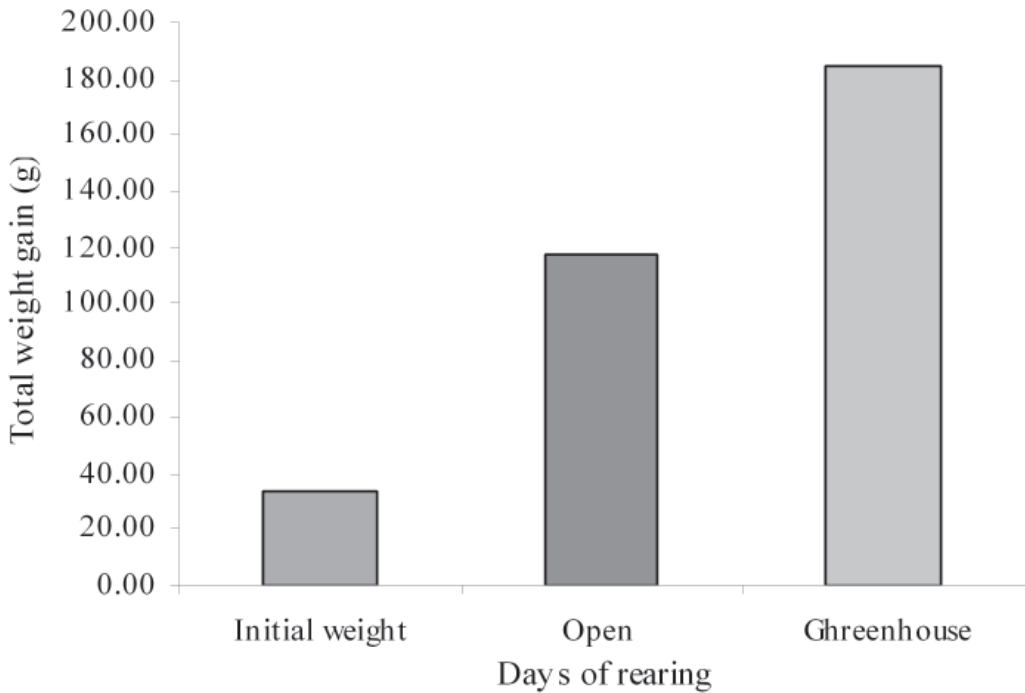

Fig. 6.3. Total weight gain of fish in 180 days rearing period in open and greenhouse pond during the experimental period. The fishes were fed with supplementary pelleted floating feed (Godrej make) with protein content 30% and @ 2-3 % of fish biomass twice a day during the entire cultured period. Feeding rates were adjusted periodically for weight gain in fish. The sampling was done at 15 days interval throughout the rearing period to assess the growth of the cultured fishes. Water, ambient air and greenhouse air temperatures were measured on hourly basis once in a week with glass bulb thermometer having least count of 1°C. Water quality parameters *e.g.*, dissolved oxygen, pH, transparency, free carbon dioxide, total alkalinity, ammonia, nitrite and nitrate were monitored once in a week. The water quality parameters were analyzed as per the standard laboratory procedures (APHA, 1998). Phytoplankton and zooplankton samples were taken from both the ponds for qualitative and quantitative analysis in every fortnight.

The water temperature in greenhouse pond was recorded higher than that of open-air pond throughout the experimental period (Table 6.4.). This was due to heating of water by greenhouse effect and simultaneous reduction of thermal loss during night hours. Hourly variation of temperature of water in greenhouse and open-air pond; greenhouse room and ambient air on a typical colder day (13.01.2008) is represented in Fig. 6.4. The maximum water temperature was recorded at 15:00 h of the day and minimum temperature was in the morning hour at 5:00 h. Klemetson and Rogers (1985) could

achieve 2.8-4.4°C increase in water temperature for each month of the year in greenhouse or plastic shelter pond when compared with an open-air pond. According to Brooks and Kimball (1983), 9°C rise in water temperature could be achieved in January in Phoenix, USA in a solar heated aquaculture pond.

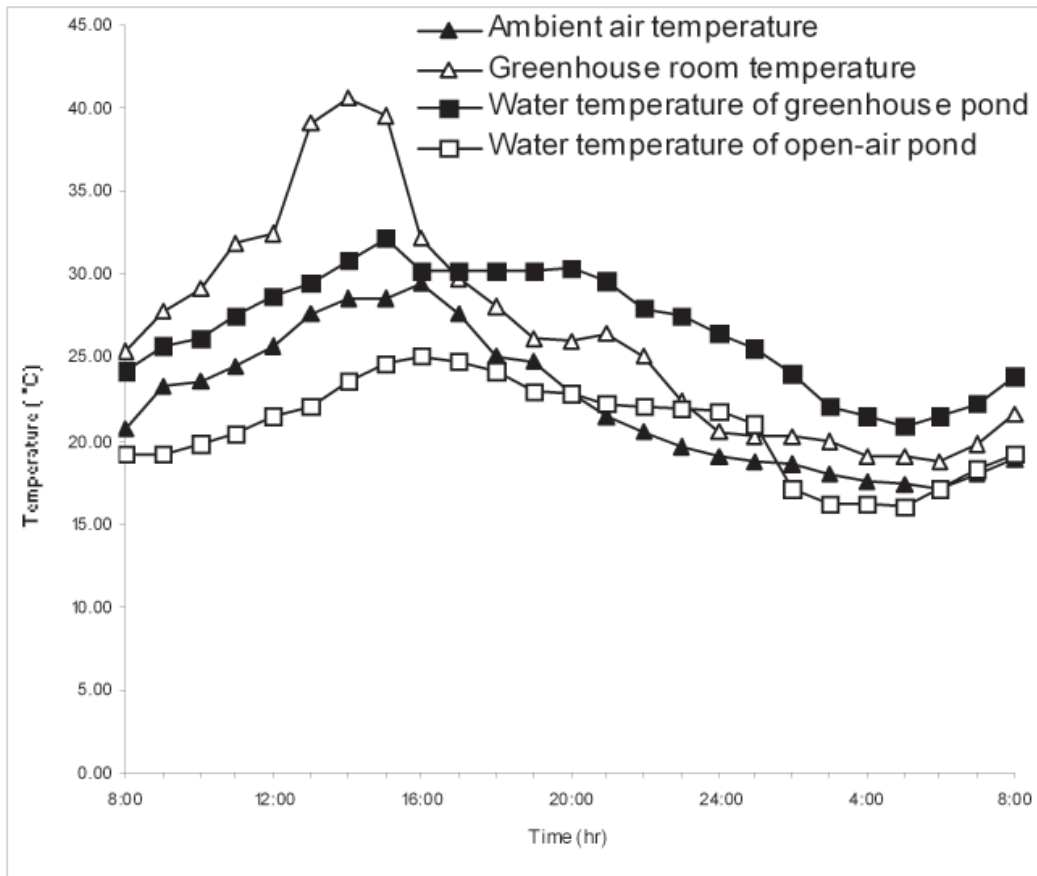

Fig. 6.4. Hourly variation of temperature with time on a typical winter day (13/01/2008)

Water quality parameters such as dissolved oxygen, pH, transparency, free carbon dioxide, total alkalinity, ammonia and nitrite (Table 6.5.) were found similar and non-significant in both the experimental ponds. Nitrate was higher in greenhouse pond water. These values were in the acceptable range for the fish rearing. However, dissolved oxygen concentration was recorded lower in greenhouse pond than the open-air pond in the morning hours. In greenhouse pond, greater respiration by pond biota (fish, plankton and benthic organisms) in higher temperature than the open pond added to the depression of O_2 concentration during night time. But in afternoon hours dissolved oxygen concentrations were of similar magnitude in both types of ponds. Plankton mass was recorded significantly higher in greenhouse pond water. Zooplankton

community was dominated mainly by Naupli, Cyclops, *Daphnia* sp., *Moina* sp., *Brachionus* sp. and *Keratella* sp. Phytoplankton was dominated by *Cosmarium* sp., *Senedesmus* sp. *Cyclotella* sp., *Anabaena* sp., *Pandorina* sp., *Oscillatoria* sp., *Merismopedia* sp., *Nitzschia* sp., *Navicula* sp., *Melosira* sp., *Gyrosigma* sp., *Fragillaria* sp. and *Synedra* sp. Higher concentration of nitrate (Lovejoy *et al.*, 2004) and temperature (Mathew, 1975) contribute to the higher production of plankton in water medium. Similarly higher nitrate concentration and temperature had contributed to the higher production of plankton in the greenhouse pond water. These plankton species were suitable as live feed for fish and their abundance had contributed to the significant higher fish growth in greenhouse pond than control.

Table 6.4. Water temperature (°C) (Mean ± SD) in greenhouse and open-air pond during winter months at CIFA, Bhubaneswar

Months	Open-air pond		Greenhouse pond	
	Min.	Max.	Min.	Max.
December, 2007	17.1±0.71	26.0±1.09	25.1±1.13	31.4±1.46
January, 2008	16.2±1.17	25.1±1.03	21.4±1.04	32.2±1.01
February, 2008	19.1±0.47	28.0±1.07	22.1±0.97	32.3±1.09
March, 2008	21.2±0.83	28.3±1.17	25.1±1.01	32.1±1.56

Table 6.5. Water quality parameters in greenhouse and open-air pond during winter months of 2007-2008 at CIFA, Bhubaneswar

Parameters	Open air-pond	Greenhouse pond
Dissolved oxygen (mg/l)	6.4±2.7	5.2±1.9
Free CO ₂ (mg/l)	6.1±1.85	7.0±2.1
Transparency (cm)	21.0± 3.2	17.5±2.8
pH	7.3±1.2	7.4±1.3
Total alkalinity (mg/l as CaCO ₃)	112.0±22.3	105.0±19.7
NH ₄ -N (mg/l)	0.037±0.09	0.041±0.17
NO ₂ -N (mg/l)	0.021±0.012	0.026±0.018
NO ₃ -N (mg/l)	0.029±0.017	0.059±0.02
Phytoplankton density (×10 ³)	9.4±3.1	19.1±5.3
Zooplankton density (×10 ³)	4.0±1.2	6.4±2.7

The fish rearing trial of 99 days indicated the promising result in terms of growth in greenhouse pond than open-air pond. The mean size of rohu was 152.52 g (76.67 g higher over initial) and percentage increment in growth was 101 in greenhouse pond. Where as, in open-air pond the mean harvest size was 104.2 g (28.33 g higher over initial) with percentage increment of 37. The percentage survival was 96 and 84 in greenhouse and open-air ponds respectively. In greenhouse ponds the predation of fishes by birds was nil.

6.4.2. Carp Polyculture

The biological experiments were initiated during November 2003 in two open and two polyhouse ponds with an effective water area of 50 m² each. The advanced carp fingerlings were stocked. The ratio of carp species was Catla-30%, Rohu-40% and Mrigal-30%. The stocking density of fishes was 5,000 nos/ha. The size range was 25-35g. The pellet feed was prepared in the proportion of rice bran-50% and groundnut oil cake-50% for the experiment and fed regularly @ 2-3% of the body-weight. The air and water parameters were recorded regularly. The carp species grew to 245 and 130 g (mean growth) in polyhouse and open ponds respectively after three months of culture. The results are given in Tables 6.6. & 6.7.

Table 6.6. Carp polyculture experiment in polyhouse and open ponds

Parameters	Open Pond			Polyhouse Pond		
	O-1	O-2	Ave. of O-1 & O-2	P-1	P-2	Ave. of P-1 & P-2
Effective water area (m ²)	50	50	50	50	50	50
Water depth in pond (m)	1.0	1.0	1.0	1.0	1.0	1.0
SD-fish (nos/ 10m ²)	5	5	5	5	5	5
Numbers stocked (Fish)	25	25	25	25	25	25
Rearing period (days)	90	90	90	90	90	90
Stocking size (Fish-g)	25-35	25-35	25-35	25-35	25-35	25-35
Fish recovered (nos)	18	21	19.5	25	23	24
Final size range –Fish (g)	90-170	95-195	95-195	165-300	165-300	165-300
Mean size fish (g)	127.0	133.1	130.05	246.2	241.7	243.9
Survival of fish (%)	72	84	78	100	92	96
Production (kg/ha/crop)	457	559	508	1231	1111	1171
Gross production (kg/ha/yr)	1829	2236	2032	4924	4447	4685
Net production (kg/ha/yr)	1826	2233	2029	4921	4441	4684
Net gain (%)	-	-	-	-	-	231

(P= Polyhouse pond, and O= Open pond)

6.4.3. Common Carp Seed Rearing

Common carp, *Cyprinus carpio* (L.) seed/ spawn was reared in polyhouse and control (open) nursery pond environments during January - February, 2002. The ponds were prepared as per the recommended practices. Spawn was stocked @ 5 million/ha in all the experimental ponds. Supplementary feed (rice bran, groundnut oilcake and wheat flour in the ratio of 1:1:1) was given @ 4, 6 and 8 times of initial body weight of spawn during 1st, 2nd and 3rd weeks of rearing respectively. The temperature difference of 4-6°C of water was recorded in between polyhouse and open nursery ponds, being the temperature in polyhouse ponds at higher side. After 20 days of seed rearing in control

Table 6.7. Physico-chemical parameters of open and polyhouse ponds (NV=No visibility)

Parameters	Open Pond			Polyhouse Pond			
	Dec.	Jan.	Fe.	De.	Jan.	Feb.	
R. humidity	Max	92.6	93.16	94.02	95.39	95.27	95.78
	Min	39.6	57.45	53.55	63.72	64.00	55.1
Air Temperature (°C)	Max	26.56	26.02	29.33	34.0	36.44	36.45
	Min	16.28	15.36	17.38	18.0	19.2	20.5
W. Temperature (°C)	Max	24.95	25.98	26.12	28.26	28.3	31.7
	Min	20.09	20.81	22.15	24.14	24.92	25.11
Light intensity 10 ² (Lux)	Max	240.16	278.7	290.1	149.45	164.24	159.8
	Min	NV	NV	NV	NV	NV	NV
D.O.(mg/l)	Max	6.0	7.0	6.4	7.6	8.4	8.6
	Min	3.0	3.2	2.8	2.8	3.0	2.4
Free CO ₂ .(mg/l)	Max	14.0	12.0	16.0	12.6	14.0	16.0
	Min	NIL	NIL	NIL	NIL	NIL	NIL
pH	Max	7.9	8.0	8.4	7.6	8.0	8.6
	Min	7.2	7.1	7.0	7.3	7.3	7.2
Phytoplankton 10 ³ /l	Max	12.2	12.0	10.0	15.2	18.3	19.2
	Min	4.61	3.2	4.6	4.8	6.0	5.8
Zooplankton 10 ³ /l	Max	2.36	2.46	4.6	3.6	2.8	3.0
	Min	1.23	1.2	2.8	1.26	1.3	1.28

and polyhouse ponds, mean growth and survival of fry from spawn were 19.7 mm / 0.139 g (40.2%) and 21.95 mm / 0.202 g (61.5%) respectively. The desirable planktonic density was higher in polyhouse ponds than that of control ponds. The observation revealed that the growth and survival of fish seed were remarkably higher in polyhouse ponds than the open ponds in cooler periods of the year.

6.4.4. Monoculture of Giant Freshwater Prawn

Growth of post-larvae of *Macrobrachium rosenbergii* reared in polyhouse earthen ponds was evaluated during the winter (1996-97). The polyhouse ponds along with two control ponds were stocked with post-larvae (0.013±0.004 g) at 40,000/ha stocking density. Prawns were fed with the formulated feed (35% crude protein) @ 10% of the biomass and reared for 100 days. The percentage survival varied widely (24-82) in different ponds. Average daily growth of prawn in polyhouse ponds was found to be 83.72% higher than the control ponds. The major difference between experimental polyhouse and control ponds was the water temperature. The average early morning (minimum) and afternoon (maximum) water temperatures were 21.23±1.88 and 24.4±2.1°C for control ponds, and 24.4±2.1 and 26.89±1.76 °C for polyhouse ponds. The average temperature differences between the experimental and control ponds were 3.09°C. The minimum water temperature in the control and polyhouse ponds was 17.0 and 19.8°C respectively.

6.4.5. Carp Polyculture with Giant Freshwater Prawn

The biological experiments were initiated during October 2002 in two open and two polyhouse ponds with an effective water area of 50 m² each. The advanced carp

fingerlings and giant freshwater prawn ten days old post-larvae were stocked in the open and polyhouse ponds for the experiments. The ratio of carp species was silver carp 10%, catla 20%, rohu 25%, common carp 5%, punti (*Puntius gonionotus*) 25%, grass carp 10% and mrigal 5%. The stocking density of fishes was 10,000 nos/ha and of prawn was 25,000 nos/ha. The size range was 8-15 g for fishes and 10-12 mm/ 10 mg for prawn. The pelleted feed was prepared in the proportion of rice bran 37%, GOC 38%, soybean meal 20% and fish meal 5% and fed regularly @ 2-3% of the body weight. The experiment got completed in March 2003. The results are given in tables 6.8. The production levels were of 6,204-7,767 kg/ha/yr for carps and 92.5-97.3 kg/ha/yr for prawns under polyhouse conditions against 3,327-3,935 kg/ha/yr for carps and 43.8-77.9 kg/ha/yr for prawns in non-polyhouse (open) ponds. Trials on carp polyculture indicated that higher production level of 202% for fish and 156% for prawn could be obtained in polyhouse ponds compared to that of control ponds during winter periods. Growth and survival of fish and prawn were higher in polyhouse ponds (fish mean growth 311.0g with 86% survival; prawn 11g with 17.6% survival) than open ponds (fish mean growth 216.5g with 75% survival; prawn 7g with 14% survival) during experimentation. In each month of experiment the water temperature and physico-chemical parameters of the control and experimental ponds were recorded. The monthly minimum mean water temperature was 17.2 in open pond and 21.2°C in polyhouse ponds during January, whereas, highest was 32.1 in open pond and 35.7°C in polyhouse ponds during March.

Table 6.8. Carp and prawn polyculture experiment in polyhouse and open ponds

Parameters	O-1	O-2	P-1	P-2
Effective water area (m ²)	50	50	50	50
Water depth in pond (m)	1.2	1.2	1.2	1.2
SD-fish/ prawn (nos/ 10m ²)	1/ 2.5	1/ 2.5	1/ 2.5	1/ 2.5
Numbers stocked (fish/ prawn)	50/125	50/125	50/125	50/125
Rearing period (days)	150	150	150	150
Stocking size (fish/ prawn-g)	8-15/10	8-15/10	8-15/10	8-15/10
Fish/ prawn recovered (nos)	38/20	40/15	42/25	44/19
Final size range (fish/ prawn- g)	145-295/ 6-10	128-358/ 5-8	208-433/ 10-15	225-425/ 8-12
Final mean size (fish/ prawn- g)	212.14/8	220.85/6	313.4/12	304.6/10
Survival (fish/ prawn- %)	76/12	74/16	84/20	88/15.2

(P= Polyhouse pond, and O= Open pond)

Table 6.9. Water quality parameters

Parameters	Open air-pond	Greenhouse pond
Dissolved oxygen (mg/l)	4.4±0.7	4.2±0.5
Free CO ₂	9.1±1.85	10.5±2.1
pH	7.3±0.2	7.4±0.3
Total alkalinity (mg/l as CaCO ₃)	112.0±22.3	105.0±19.7
NH ₄ -N (mg/l)	0.037±0.09	0.041±0.17
NO ₃ -N (mg/l)	0.029±0.017	0.059±0.02
Phytoplankton density (×10 ³)	9.4±3.1	19.1±1.3
Zooplankton density (×10 ³)	4.0±1.2	2.4±0.7

6.5. Conclusion

The fish culture in polyhouses at CIFA farm, Bhubaneswar has been reviewed in this chapter. Some reports are also available from India on fish culture. Khan *et al.* (2004) had conducted a 122-day trial to observe the impact of polyhouse in winter on growth, conversion efficiencies and body composition of *Labeo rohita* fingerling. At the end of the trial they could observe that the polyhouse reared fish produced significantly higher values of these parameters. Kumar *et al.* (2000) reported the common carp fingerlings rearing in a greenhouse pond in the Himalayan region. They stocked the pond @ 10,000/ha and found 81% higher growth in fish inside the greenhouse than 11% in open condition within a rearing period of five months. In a field experiment for 20 days at CIFA, Bhubaneswar, Mohapatra *et al.* (2000) reported 45% higher growth rate of common carp spawn in the greenhouse pond. Higher growth rates in IMC from polyhouse pond culture operations (more than 100% in most of the culture operations) were achieved at CIFA could be attributed to the higher temperatures of water in these ponds. The studies showed that the plastic covered ponds can keep the water temperature 5.2-7.0 °C higher than the open-air ponds in the colder season at Bhubaneswar. It is desirable to use these ponds in conjunction with hatcheries for advancing maturity of the brood stock and raising fry/ fingerlings. In off seasons, the polyhouses could be utilized for fish drying, or for other economic activities. However, the benefits of temperature rise in polyhouse pond in winter period are to be utilized for aquaculture purposes in India.

References

- APA/CIFA, 1993-2003. *Annual Progress Reports of AICRP on Application of Plastics in Agriculture*, CIFA, Bhubaneswar, India.
- APHA (American Public Health Association), 1998. *Standard Methods for the Examination of Water and Wastewater*. APHA, AWWA, WPFC, 16ED, New York.
- Bandyopadhyay, M. K., S.D. Tripathi, P.K. Aravindakshan, S. K. Singh, Bikash Sarkar, D. Majhi and S. Ayyappan, 2000. *Fish culture in polyhouse ponds- a new approach*

- for increasing fish production in low temperature areas. *The Fifth Indian Fisheries Forum*, Bhubaneswar, 17-20 January, 2000, 7p.
- Bansal, N.K. and G. Minke, 1988. Climatic zones and rural housing in India. *Indo-German Project on Passive Space Conditioning, Part-I*.
- Brett, J. R., 1979. Environmental factors and growth. In: *Fish Physiology*. Academic Press Inc., Florida, **8**: 665-666.
- Baruah, H.K., P. Barua, and J. Saikia, 2000. Application of plastic tunnel for overwintering of carpfish. *J.agric.Sci. Soc.*, NE India ,**13**(2):218-221.
- Brooks, Jr., G.B. and B.A. Kimball, 1983. Simulation of a low cost method for solar heating and aquaculture pond. *Energy in Agriculture*, **1**: 281-285.
- Chakraborty, R.D, P.R. Sen, N.G.S. Rao and S. Ghosh, 1979. Intensive culture of Indian major carps. In: *Advances in Aquaculture*, Pillay, TVR and W.A.Sdill (Eds), Fishing News Book England, 153-156p.
- CIFE, 1998-99/2001-02. *Annual Reports*, Central Institute of Fisheries Education, Versova, Mumbai.
- Corey, P.D., D.A. Leith and M.J. English, 1983. A growth model for Coho salmon including effects of varying rations allotments and temperature. *Aquaculture*, **30**:125-143
- Degani, G., 1991. Effect of diet, population density and temperature on growth of larvae and juveniles of *Trichogaster trichopterus* (Bloc. & Schneider 1801). *J. Aqua. Trop.*, **6**:135-141.
- Halver, J.E., 1972. *Fish Nutrition*. Academic Press, London: 541p.
- <http://archives.nic.in/tecnofocus/june99/high.htm>. *Technology Focus*, **7**(3), June 1999.
- Jain, D., 2006. Modeling the thermal performance of an aquaculture pond heating with greenhouse. *Building and Environment*, **42**: 557-565.
- Jhingran, V.G., 1975. *Fish and Fisheries of India*. Hindustan Publishing Corporation (India), Delhi: 954p.
- Jobling, M., 1983. Bioenergetics: feed intake and energy portioning, In: Rankin, J.C., Jension, *Fish Eco-physiology*. Chapman & Hall, London, 1-44.
- Khan, A.M., A.K. Jafri and N.K. Chadha 2004. Growth and body composition of rohu, *Labeo rohita* (Hamilton), fed compound diet: winter feeding and rearing to marketable size. *J. Appl. Ichthyology*, **20**(4): 265-270. Klemetson, S.L. and G.L. Rogers, 1985. Aquaculture pond temperature modeling. *Aquaculture Engineering*, **4**: 191-208.

- Kumar, Ashok, C.K. Pandey and N.Kumar, 2000. Effect of polyhouse on growth of common carp at high altitude of central Himalayas during winter. *J. Aqua.*, **8**: 73-75.
- Lakhamanan M.A.V., K.K. Sukumaran, D.S. Murthy, D.P. Chakraborty and M.T. Phillips, 1971. Preliminary observation on intensive fish farming in freshwater ponds by the composite fish culture Indian and exotic species. *J. Inland Fish soc. India.* **3**:1-21
- Lovejoy, C., N.M. Price and L. Legendre, 2004. Role of nutrients supply and loss in controlling protist species dominance and microbial food-webs during spring blooms. *Aquatic Microbial Ecology*, **34**: 79-92.
- Mathew, P.M., 1975. Limnology productivity of Govindgeth Lake, Rewa, Madhya Pradesh. *J. Indian Fish Soc.*, **7**: 16-24.
- Mohapatra, B.C., S.K. Singh, Bikash Sarkar, D. Majhi, C. Moharathi and K.C. Pani, 2002. Common carp, *Cyprinus carpio* (L.) seed rearing in polyhouse pond environment during low temperature period In: *Sixth Indian Fisheries Forum*, Central Institute of Fisheries Education, Mumbai, 17-20 December, 2002, 4p.
- Mohapatra, B.C, B. Sarkar and S.K. Singh 2003. Application of plastics in aquaculture published in the book 'Plasticulture Intervention for Agriculture Development in NEH region' edited by K.K Satpathi and Ashwani Kumar, Published by Dr. K. M. Bujarbaruah, Director ICAR Research Complex for NEH Region, Meghalaya pp:290-305.
- Mohapatra, B.C., S.K. Singh, B. Sarkar, D. Majhi and N. Sarangi, 2007. Observation of carp polyculture with giant freshwater prawn in solar heated fishpond. *Journal of Fisheries and Aquatic Sciences*, **2**(2): 149-155.
- Nikitin, P. P., 1996. Hibernation of carp fingerlings in tanks or hibernation houses, Sbornic Rybn. Khozvo, V. *Nutr. Vodoemoulatv, SSR, IZD, Acad Nauk hatv, SSR Vol.6*
- Pillai, B.R., A.P. Tripathi and K.J. Rao, 1999. Observation on the growth of post-larvae of *Macrobrachium rosenbergii* in polyethylene sheet covered earthen nursery pond during winter. *Indian J. Fish.*, **46**: 57-59.
- Ra'anana, Z and D. Cohen, 1980/81. Production of the freshwater prawn *Macrobrachium rosenbergii*, in Israel. Winter activities. *Bamidgeh*, **34**:47-58.
- Sarkar, B and G.N. Tiwari, 2006. Thermal modeling and parametric studies of a greenhouse fish pond in the central Himalayan Region. *Energy Conversion and Management*, **47**(18-19): 3174-3184.

- Schaperclaus, W., 1961. *Lehrbuch der Teichwirtschaft*. P. Parey. (Ed.) Verlag, Berlin: 582p.
- Sinha, V.R.P., M.V. Gupta, M.K. Banerjee and D. Kumar, 1973. Composite fish culture in Kalyani. *J. Inland Fish. Soc. India*, 5:201-208.
- Tiwari, G.N., B. Sarkar and L. Ghosh. 2006. Observation of Common carp (*Cyprinus carpio*) fry-fingerlings rearing in a greenhouse during winter period. *Agricultural Engineering International: the CIGR Ejournal*, FP 05 019, Vol. VIII.
- Tripathi, S.D., 2001. New dimensions in Indian aquaculture. *J. Applied Fisheries and Aquaculture*, 1 (1): 129-132.

FISH FEEDERS

B.C. Mohapatra, Bikash Sarkar, S.K. Singh, Dukhia Majhi and K.K. Sharma

One of the major components of the scientific fish culture is to provide artificial feeds to the fishes according to their requirement, reducing feed loss and maintaining suitable culture environment. It is the most important challenge to the engineers for proper designing of feeding devices for fish farms. Several authors have reported different types of automatic fish feeding devices (Baldwin 1983; Charlton and Bergot, 1986; Parker 1989; Mohapatra *et al.*, 2003) and different kinds of demand feeders (Meriwether, 1986; Alexander *et al.*, 1993; Alanara, 1996; Mohapatra *et al.*, 2003 & 2009; Rubio *et al.*, 2004). Many of the existing feeders operate successfully with pellet or powder feed (Parker, 1989), but, these are not tested for carp feeding in Indian condition. In most of the automatic feeders, it is difficult to adjust the exact time and amount of feed to be delivered to fish, as well as real feed demands and appetite of the fish. Sometimes it leads to over feeding, wastage of food and pollution of pond water. From these points of view, the self-demand feeders appear to be more preferable and fish themselves decide when and what amount of feed they consume. Because of some good qualities such as easy to fabricate, low cost and maintenance free, the demand feeders will be more useful in aquaculture sector.

7.1. Demand Feeder

7.1.1. Design and Development of Demand Fish Feeder

The demand feeder was designed with an angle of repose 50° and fabricated with FRP material for pellet feed for outdoor culture systems to feed the fish. The angle of repose/angle of inclination plays an important role in designing any feeding devices for aquaculture purposes. In demand feeding system, feed drops by gravitational force, which is directly related to the angle of repose. Before designing the feed hopper, the angle of repose was calculated to be 41° for pellet feed of size (specific weight: 0.49 g/cc ; feed diameter: $2.5 \pm 0.16 \text{ mm}$ and avg. length $8.7 \pm 1.19 \text{ mm}$) at normal room temperature. In the present design, we have taken the angle of repose as 50° , which was slightly higher than the actual required angle of repose (41°) for effective and free flow of feed material (Fig. 7.1.).

Demand fish feeder of FRP material designed and developed at APA Centre, CIFA for pellet feed for fish culture systems (Mohapatra *et al.*, 2003 & 2009) has main components of 30 l capacity feed hopper and activated mechanism. The feeder is designed to be installed in a pond with the activating mechanism extending into the water through an

activator rod (Fig. 7.2.). The activating mechanism includes a steel bait rod, feed platform, feed protecting cover and a pendulum or feeding tray in case of sinking feed. The feed drops by gravity onto the adjustable acrylic feed platform positioned below the hopper and above the water level, when fish activates the rod. An acrylic tube protects the feed platform, which is fitted with hopper. The bait-rod is suspended from the conical tube on V-shaped steel wire that holds the rod. The feeder can be suspended from a MS pipe stand with the activating mechanism extending into the water through the conical portion of the hopper.

In 2007, the fabrication cost of the feeder was about Rs. 3,100 or US \$ 69 (Table 7.1.). The FRP feed hopper was fabricated from a wooden mould by hand-lay up process. A threaded rigid PVC short piece (SCH-80) of 50 mm diameter and 50 mm length is joined at the end of conical bottom of the hopper. The joint is reinforced with glass fibre. A rain protecting cover of 200 mm diameter and 150 mm length was fabricated from acrylic (PMMA) tube, where one end is covered with a 5 mm thick acrylic sheet with a 50 mm diameter hole at the centre of it. The rain protecting cover is fixed to the threaded portion of the conical bottom with two numbers threaded PVC socket (f50×20 mm). For holding the bait-rod, two numbers of MS angles (L shaped with 5 mm diameter hole) are riveted with the body at a distance of 380 mm from the top of the hopper. Steel clutch wire along with the bait rod is fixed between the two clamps and the other end of the wire, a draw nut is fitted to adjust the length of wire. The bait rod (f 5 × 600 mm) is cut at a distance of 400 mm from the bottom and a threaded bolt of M 6 × 100 mm is welded to it to hold the feed platform. At the bottom end of the bait-rod, another bolt of M 6 × 50 mm is welded to hold the pendulum/ tray. The feeder is placed on the top of a cantilever MS pipe (f25 mm) ring with the activating mechanism extending into the water (Fig. 6.2.) of the rearing cistern. The length of activating rod in the water is kept at 450-600 mm. Feed dropped by gravity on to the adjustable acrylic feed platform (f 80 × 5 mm) positioned below the hopper and above the water level on free-swinging activator rod. When fish activated the rod, feed pellets retained on the feed platform slowly dropped on the water surface. The gap (distance) between the feed platform and the end of the hopper cone is adjusted as per the size of the pellet feed.

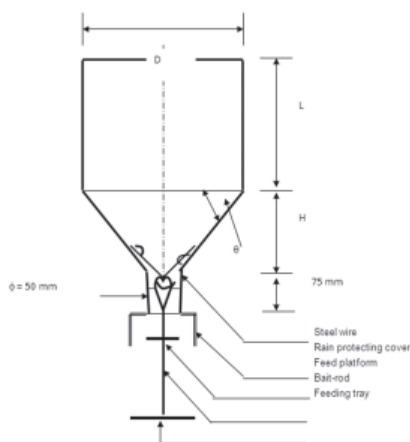

Specifications of feed hopper

Length of the cylinder (L): 285 mm

Diameter (D): 330 mm

Height of cone (H): 200 mm

Angle of repose/ inclination (θ): 50°

Centre of gravity: 342.5 mm from base

Volume (V): 30 l

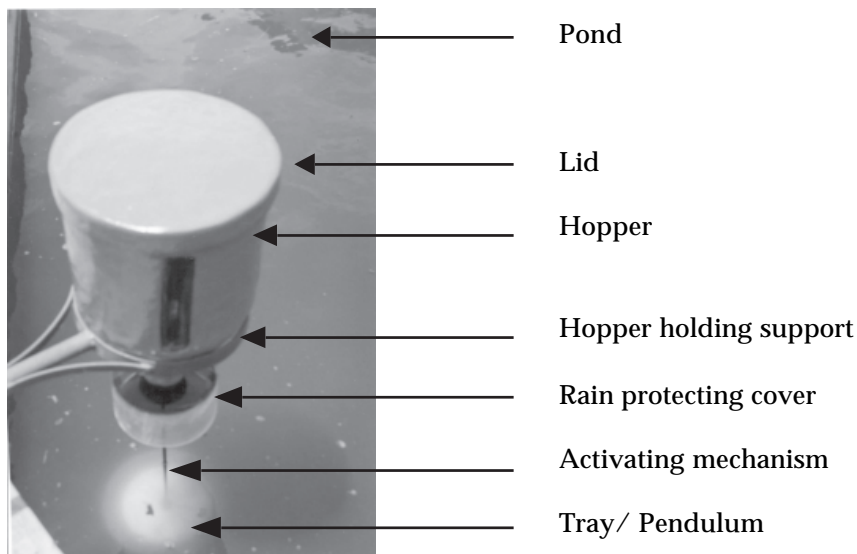
Fig. 7.1. Schematic diagram of FRP demand feeder hopper**Fig. 7.2. View of the demand feeder installed in a fish rearing tank****Table 7.1. List of materials required for fabrication of one FRP demand fish feeder (Cost during April 2007)**

Sl. No.	Description	Qty	Unit Cost (Rs.)	Total cost (Rs.)
1	FRP feed hopper (30 l)	01	1250	1250
2	FRP hopper lid	01	475	475
3	Acrylic pipe: $\phi 200 \times 150$ mm length	01	250	250
4	Acrylic sheet: $\phi 200 \times 5$ mm thick	01	75	75
5	Steel wire (Clutch wire)	01	11	11
6	Jam nut	01	4	4
7	RPVC Socket: $\phi 50 \times 15$ mm	02	6	12
8	RPVC Nipple: $\phi 50 \times 75$ mm	01	9	9
9	Bait rod: $\phi 3$ mm	01 m	40	40
10	Nut & Bolt: M 6 \times 100	01	25	25
11	Nut & Bolt: M 6 \times 50	01	20	20
12	Feed disc: $\phi 100 \times 5$ mm thick	01	8	8
13	MS pipe: $\phi 25$ mm (M)	01m	120	120
14	MS pipe: $\phi 32$ mm (M)	01 m	155	155
15	MS flat	01m	45	45
16	Cement concrete	0.2 m ³	1800	360
17	Miscellaneous (Paints, GI wire, ropes, etc.)	PP L.S	-	241
	Total	-	-	3100

(Rs 3,100 or US \$ 69 based on Indian rupee in 2007)

7.1.2. Fish Feeding Experiment

7.1.2.1. In Silo

Demand feeding experiment was conducted in silo rearing system at CIFA. There are six silos with 3, 6 and 9 m³ water volumes and 0.8, 1.6 and 2.4 m water depths respectively. Three silos with different depths of water were fitted with demand feeders each of capacity 30 l feed holding volume for 13 kg feed and the rest three silos were used for hand feeding (tray feeding). The tray feeding was done once a day. Similarly the feeders were loaded with the required quantity of feed once a day. Feeder supplied feed to fishes as and when they required it. The standard fish culture practices were followed for weight gain in fish. The fish culture data revealed that there were differential growths in fish in different depths of water in silos. It was statistically (at 5% level) significant (calculated 't' value was 2.799 with degrees of freedom 57). By pooling the data from different silos, the growth of fish fed with feeders found non-significant in comparison to control (calculated 't' value was 0.6176). The values of mean weight gain and final weight of fish is given in the table 7.2.

Table 7.2. Values of mean weight gain and final weight of fish after 120 days of rearing in silos (initial stocking size: 31 ± 2.99 g)

Mean weight gain in fish

S-1 (Hand fed)	S-2* (Demand fed)	S-3 (Hand fed)	S-4* (Demand fed)	S-5 (Hand fed)	S-6* (Demand fed)
49±2.29g	59±2.01g	79±1.10g	94±1.20g	104±1.83g	119±1.34g

Final fish weight

S-1 (Hand fed)	S-2* (Demand fed)	S-3 (Hand fed)	S-4* (Demand fed)	S-5 (Hand fed)	S-6* (Demand fed)
80±1.22	90±0.71	110±1.0	125±0.61	135±4.0g	150±3.0g

*Silos with demand feeders

S1 & S2 = Silo with vol. 9 m³, depth 2.4 m

S3 & S4 = Silo with vol. 6 m³, depth 1.6 m

S5 & S6 = Silo with vol. 3 m³: depth 0.8 m

7.1.2.2. In Cement Cisterns

The feeder was placed on a cantilever stand fixed at the corner of the cemented cistern of capacity 10 m³ for feeding Indian major carp, *Labeo rohita* reared in it. The demand

feeding experiment was conducted in triplicate. At the same time similar three cisterns were used as controls, where the fish were hand-fed. The fish stocking density was 6 nos/m³. The average initial stocking size of rohu was 31 g. The duration of the experiment was from 29th April to 17th August 2007. Normal fish rearing practices were followed and the fishes were fed daily with pellet feed (crude protein 26.6%, ether extract 7.8%, crude fibre 6.2% and ash 10.5%) @ 2-3% of their body weight. Every day 10-15% of water was replaced in the cisterns from near by canal. The water quality parameters such as dissolved oxygen, carbon dioxide, total alkalinity, pH, ammonia, nitrite, nitrate and phosphate were analyzed in every fortnight by standard laboratory procedures (APHA, 1998). Growth of fish was estimated by sampling fish from each cistern in every fortnight. Based on the growth of fish, the feed quantity was determined and supplied to the rearing cisterns through feeders or by conventional means. The feed conversion ratio (FCR) was calculated using Eq. (7.1.).

$$FCR = \frac{\text{Feed consumed by fish in gram}}{\text{Weight gain by fish in gram}} \dots\dots\dots (7.1.)$$

In hand fed method, the feed was provided to fish once daily in morning hour. In case of demand feeding, the feeders were loaded once in a week with predetermined quantity of feed for continuous delivery to fishes. In 110 days of rearing, rohu grew to 150 g (net growth 119 g) and 135 g (net growth 104 g) in demand and hand-fed cisterns respectively. The growth rates of fishes were 12.61% higher in the demand feeding cisterns with feeders than the control. The efficiency of demand feeding by considering the FCR is the major factor, which was found significantly (at 5% level) superior than the control. Feed conversion ratios differed among the cisterns, but the average FCR was found superior in demand-fed system (Table 7.2.). The observation showed that in hand-fed cisterns more feed was required (4.9 kg) for fishes including wastage than the demand-fed cistern (3.62 kg) to produce fish biomass. During 110 days of experiment, total of 25.86 and 30.58 kg pellet feed were used to produce 7.15 and 6.25 kg of fish in demand and hand-fed cisterns respectfully. The cost was calculated approximately Rs 11/- per kg of feed in 2007. By using demand feeder, 4.72 kg feed worth of Rs 51.90 (say Rs 52/-) was saved during the experiment. The feeders were loaded with feed once in a week. During 110 days of experiment, 94 days the feeders were not loaded with feed. Considering a saving of half an hour every day for feed loading, total man-hour was saved i.e. 47 hr. The cost saved from man-hours calculated @ Rs 20/- per hour was Rs 960/-. Total cost saving from feed and labor was Rs 1012/- . It is known that the FRP products exposed to outdoor conditions can last up to ten years (Mohapatra *et al.*, 2004). Thus, the depreciation value of the feeder for four months was calculated to be Rs 103/- only, which was less than the cost saved from feed and labor during the experiment. It justified that the use of feeder in rearing system is beneficial and economical to the users.

Table 7.3. Weight gain of *Labeo rohita* and feed conversion ratio in demand feeding and control cisterns

Treatment	Initial weight (g)	Total weight gain (g)	Feed conversion ratio (FCR)
Hand fed	31 ± 1.19	135 ± 1.79g	4.90 ± 0.1
Demand fed	31 ± 1.11	150 ± 1.07g	3.62 ± 0.02

The hopper of the feeder can hold 10 kg of feed, and if fed @ 2% of the body weight of fish per day, it can be used for feeding 500 kg of fish in the rearing system. In hand-fed system, if 10 kg feed is to be used for fish, it will be difficult to know the quantity of feed that has gone waste in the rearing medium. In feeder once 10 kg feed is loaded for feeding the fish, after the day, rest of the feed will remain in the feed hopper and can be used in next day. This will avoid organic pollution in the rearing system by delivering excess feed into it. This can also provide indication to the culturist regarding the feed demand of fish. The present study indicated that the demand feeders will increase feed consumption in fish by making it available to them continuously.

The water quality did not differ significantly between the demand and hand-fed rearing cisterns (Table 7.3.). It might be due to the daily replacement of 10-15% water in the cisterns with freshwater drawn from near by canal. The digest of water quality standards for the protection of cyprinid fish is DO (100% of samples ≥ 5.0 mg/l); pH (6.0-9.0); nitrites (≤ 0.03 mg/l NO_2) and non-ionized ammonia (≤ 1.0 mg/l NH_3) (EEC, 1978). In the present experiment none of the water quality parameters exceeded the limit.

Table 5.1. Results of rohu rearing in silo

Water parameter	Source water (canal)	Demand-fed cistern	Hand-fed cistern (control)
D.O. (mg/l)	4.4±0.5	3.8±0.8	3.6±0.6
pH	7.4±0.2	7.1±0.3	6.9±0.5
Free CO ₂ (mg/l)	8.0±1.5	10.0±2.0	12.0±2.2
Total alkalinity (mg/l)	140±5.5	136±8.0	130±14.0
P ₂ O ₅ (mg/l)	0.05±0.01	1.09±0.4	1.32±0.8
NH ₄ -N (mg/l)	0.06±0.02	0.21±0.06	0.33±0.06
NO ₃ -N (mg/l)	0.02±0.05	0.15±0.06	0.19±0.04
NO ₂ -N (mg/l)	Trace	0.003±0.001	0.005±0.001



Fish feeding in pond by demand feeder



Fish feeding in cisterns by demand feeder

7.1.3. Merits of Demand Feeder

- Low cost and easy fabrication
- Resistance to corrosion
- Maintenance free
- Easy to install and operate
- Suitable for pond/ tank/ raceways
- Stable for adverse climate
- Suitable for advanced fingerlings and above size

7.2. Automatic Fish Feeder

7.2.1. Design

An Electro-magnet operated automatic fish feed dispenser of 30 l capacity consisting of four major components viz., Feed hopper, Hopper lid, Housing box and Floating buoy was designed and fabricated at APA center, CIFA for operation in aquaculture system (Mohapatra *et al.*, 2003) (Fig. 7.3.). The feed dispenser was fabricated using FRP material. The housing box incorporates an opening-closing mechanism (Sliding door), electro-magnet/ solenoid switch, transformer, time switches and contractor inside the box. The split-sliding doors fitted with the channel are mounted inside the housing box below the opening of the feed hopper. The end of the sliding door is connected directly with soft iron core of the solenoid by mechanical fastener. The sliding movement of door starts when the magnet is energized. The time switch (FM1) consist of a 15 min interval timer, controls the time of day when the feeder is activated. It can operate a maximum of twice per hour (two periods of 15 min ON and 15 min OFF) or as infrequently as once every 24 hours.

The quantity of feed delivered per activation cycle is controlled by adjusting the dials of the captive segments of the timer which can be radically pulled out or pressed in

while rotating when actuating mechanisms come in contact with the pulled out segments. An EM 2000 interval time switch is used with 15 min -24 hours relay if smaller quantity of feed is needed per activation cycle.

The feed outlet can be adjusted by putting different diameter of PVC bush to deliver finer or larger particles respectively. The total feeding unit is placed on the floating structure consists of HDPE floats fixed on a wooden frame for easy loading of feed materials inside the feed hopper and for its easy installation at the pond site. The floating buoy consists of 2 nos HDPE pipe (2.5 kg/ cm²) of 1000 mm length and 180 mm diameter. The pipe is sealed from both ends by heating mirror. The float is placed horizontally and a wooden frame is placed on it and clamed with U- bolt. The feeding unit is placed on the floating structure (Weight of buoy = 11 kg, Weight of feeding unit and feed = 24 (kg), fixed with M.S. angle on the wooden frame.

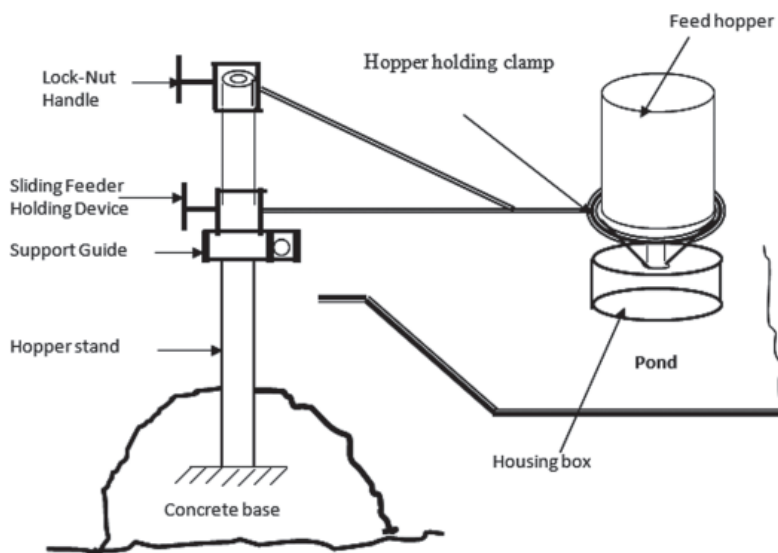

Fig. 7.3. View of automatic fish feeder with movable M.S. Stand



Fish feeding in pond by automatic feeder

7.7.7. Automatic Fish Feeder Powered by Solar Panel

The system has the power supply through 24 V battery charged by PV panels. The total unit is placed on a FRP conical float filled with proper buoyancy material as well as ballast as required for stability for floating in the pond.

7.2.2. Feed Delivery from Feeder

A series of tests were conducted in the workshop to evaluate its reliability to deliver feed at various settings. Four settings of the different feed outlet dia (25, 35, 40 and 50 mm) were tested for three different times (viz. 5 sec., 10 sec. and 15 sec.) sets by the auto-timer. Three serial replicates were conducted at each of the settings. The coefficient of variations about the average quantity of feed delivered was calculated by using Microsoft Excel program to establish repeatability of performance. This preliminary study indicates that carp starter

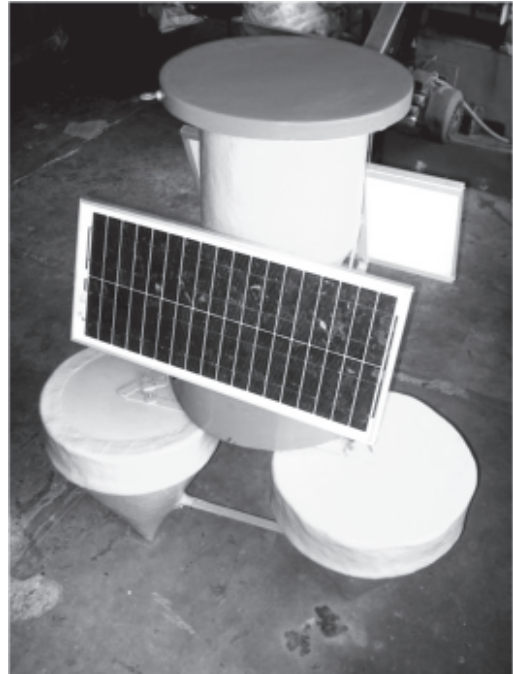

View of automatic fish feeder powered by solar panel

feed can be delivered 28.2-906.7 g at time settings of 5 sec. to 15 sec. with a 2.2 – 11.3 % error, whereas pellets of 2.5 mm and 3.0 mm can be delivered at the rate of 993 – 2491 g / cycle and 1393-4284 g / cycle with 5.6-39.5 % and 3.5-80.5 % error at 5 to 15 sec. respectively. The 25 mm feed outlet dia is not found suitable to deliver the pellets. The feeder is found to operate efficiently around the clock at pond site during different weather conditions, i.e. sunny, cloudy and rainy days.

The study also indicated that the pellets of 5.80 ± 0.29 mm diameter and 11.55 ± 1.95 mm length (Godrej floating feed) can be delivered at the rate of 0.19 ± 0.03 to 5.47 ± 0.71 g in 1 and 60 seconds, respectively (Table 7.4.).

Advantages

- Deliver a measured quantity of dry pelleted feed in different pre-determined time setting with minimum efforts
- Suitable for multiple feeding
- Power back-up supply (Storage battery) during power-off
- Reasonably weather proof
- Reduced manpower involvement except feed loading

Table 7.4. Feed delivery from automatic fish feeder

Duration (sec)	Feed delivery (kg/sec)
2	0.19 ± 0.03
4	0.58 ± 0.15
5	0.73± 0.05
6	0.94 ± 0.02
8	1.25 ± 0.04
10	1.1.47 ± 0.03
20	2.10± 0.23
25	2.90 ± 0.33
30	3.60 ± 0.18
40	4.20 ± 0.49
50	4.55 ± 0.43
60	5.47 ± 0.71

7.3. Conclusion

This particular dispenser is reliable to dispense a measured quantity of dry feed to fish. The advantages of the unit are its simple construction and trouble-free operation, and weather proof in addition; maintenance and repairs can be made on the site as its basic materials are usually available in any place. This feeding system is found to cut down the time and expense required for daily feeding in existing feeding system. The feeder is suitable for pelleted and powder like feed. Therefore it can be easily used for rearing and raising of different age group of fish.

References

- Alanara, A. 1996. The use of self-feeder in rainbow trout (*Oncorhynchus mykiss*) production. *Aquaculture*, 145:1-20.
- Alexander, P., Victor, B., Samuel, A., 1993. A universal inexpensive self-demand feeder for elvers. *Aquacultural Engineering*, 12(2): 125-127.
- APHA, American Public Health Association, Water Pollution Central Federation and American Water Works Association, 1998. Standard methods for the examination of water and wastewater. 16 th ed. Boyd. Printing Company, Albana, New york. USA.
- Baldwin, W. J., 1983. The design and operation of an automatic feed dispenser. *Aquaculture*, 34: 151 -155.
- Charlton, N and P. Bergot, 1986. An improved automatic dry food dispenser for fish larvae. *Prog. Fish Cult.*, 48: 156 -158.
- EEC,1978. Directive (78/659/EEC) on the quality of freshwater needing protection or improvement in order to support fish life. *Oj L222*. 14.8.78.

- Meriwether, F. H., 1986. An inexpensive demand feeder for cage reared Tilapia. *Prog. Fish Cult.*, 48: 226-228.
- Mohapatra, B. C., B. Sarkar, and S. K. Singh, 2003. Use of plastics in aquaculture. In: Satapathy, K. K. and Ashwani Kumar (Ed.) *Plasticulture intervention for agriculture development in North Eastern Region*. ICAR Research Complex for NEH Region, Umiam, Meghalaya: pp 290-305.
- Mohapatra, B. C., Bikash Sarkar, K. K. Sharma and D. Majhi 2009. Development and testing of demand feeder for carp feeding in outdoor culture system. *Agricultural Engineering International: the CIGR Ejournal*, Vol XI: 2009.
- Bikash Sarkar, **B. C. Mohapatra**, K. K. Sharma, D. Majhi and Ambekar E. Eknath, 2011. Design and development of solar-powered auto fish feeder. *International Conference "APA2011"*, World Aquaculture Society, Kochi, 17-27 January 2011.
- Parker, N. C., 1989. Low cost automated feeder for fry & fingerlings. *Prog. Fish Cult.*, 51: 42- 46.
- Rubio, V. C., M. Vivas, A. Sánchez-Mut, F. J. Sánchez-Vázquez, D. Covès, G. Dutto, J. A. Madrid, 2004. Self-feeding of European sea bass (*Dicentrarchus labrax*, L.) under laboratory and farming conditions using a string sensor. *Aquaculture*, 233(1-4): 393-403.

LIVE FISH TRANSPORTATION SYSTEM

P.K. Aravindakshan, S.K. Singh, Bikash Sarkar, D. Majhi and B.C. Mohapatra

Oxygen is the prime requirement of all living being and fish is no exception. Due to lack of adequate oxygen present in the water, high mortality has been noticed during transportation of live fishes (Jhingaran, 1975). Knowledge on the oxygen consumption rate is a prerequisite for determining the species-specific density of fish, size, duration of transport and water requirement.

Transportation of live fishes in large quantities is one of the major problems for aquaculture and also for sale in distant places due to unavailability of proper transportation devices. Use of oxygen filled polyethylene bag is in vogue for transportation of fish seed. Transportation of table size and brood fishes still faces difficulty. Of late, the increasing popularity of aquaculture and consumer preference for live table size fishes has attracted the attention of aqua producers and fish traders. Hence, transporting them through trucks with mounted containers, aluminum hundies, cylindrical high-density polyethylene tanks and some times canvas rolled containers are being used for the purpose. However, these transportation techniques had certain limitations and lack of scientific backup with regard to oxygen consumption of larger size fishes. Oxygen consumption rates of spawn, fry and fingerlings of carps have been studied by many workers (Basu, 1951; Hora and Pillay, 1962; Ramchandran, 1969; Singh, 1977; Selvaraj *et al*, 1981 and Bhaumik *et al.*, 1986). Fry, fingerlings, Juveniles and table fishes are transported live in various types of conventional containers by sprinkling and circulating water inside the container (Jhingaran, 1975; Jhingaran and Pullin, 1985; Ou and Li, 1996). There have been limited attempts for transport of live fishes with various methods, particularly brood fishes with certain degree of success (Mammen, 1962; Patra, 1968; Ramchandran, 1972; Das and Bhoumik, 1979). However, it is needed to know the oxygen consumption of various stages of different fish species for better live transportation to them. Therefore, an attempt has been made in AICRP on APA Centre at CIFA to study the oxygen consumption of different size live fishes in Fibre Reinforced Plastics (FRP) transportation tank for safer transport.

8.1. Design and Fabrication of Live Fish Transportation Tank

A fibre reinforced plastic live fish transportation tank was designed and fabricated at the Institute workshop of CIFA, Kausalyaganga, Bhubaneswar. It is rectangular (1.6 m length × 0.8 m breath, 1m a height and inner tank volume 1280 l), suitable for carrying in a jeep trailer or in a power trailer trolley (Fig. 8.1). The tank is provided with a top

door of 0.66 m × 0.4 m for loading and unloading of water and fish, and a rear side door of 0.3 m × 0.25 m at the bottom to drain the water and release of fishes. A vent pipe of 25 mm is provided at the top of the tank for inserting the air pipe to the tank for oxygen supply to the water in the system.

8.2. Experiments of Live Fish Transportation

Six experiments were conducted using table size fishes (425-060 g) of Indian major carps viz., *Catla catla*, *Labeo rohita*, *Cirrhinus mrigala*; and exotic carps *Hypophthalmichthys molitrix*, *Cyprinus carpio* and *Puntius gonionotus*. Before stocking the fishes in the water of FRP tank for experimentation, they were conditioned by keeping them in the breeding hapa for 4-5 hours in the pond of catch. Water was filled to maximum of 1000 l, 500 l and 250 l in transportation tank during different experiments. After stocking the fishes, the tank top door was closed airtight. Water samples were collected from the tank by a capillary tube inserted through the air vent at regular intervals. Dissolved oxygen, water temperature, pH, free carbon dioxide, ammonia and total alkalinity were analyzed following the method of (APHA, 1989).



FRP live fish transportation tank

Oxygen consumption of carp species according to the size, density and duration of the experimentation is presented in Table 8.1. The physico-chemical parameters of water of transportation tank are presented in Table 8.2. The relationship between fish and water in transportation is presented in Table 8.3. The quantification of carps for transportation at full tank capacity is depicted in Fig.8.1. The oxygen consumption rate of carp species ranged from 15.70 - 58.20 mg/kg fish/hour and 19.74 - 70.58 mg/kg fish/hour during transportation (Table 8.1.). The water temperature ranged between 30-34°C throughout the experimentation and all other water parameters were within optimum limits (Table 8.2.). Among the surface dwelling fishes, for silver carp, computed oxygen consumption was lower (54.8 mgO₂/kg/hr) compared to catla (70.58 mgO₂/kg/hr). In the column living fishes, for silver barb, oxygen consumption was lower (50 mgO₂/kg/hr) compared to rohu (68.9 mgO₂/kg/hr). Where as, in the bottom living fishes, common carp showed lowest value (19.74 mgO₂/kg/hr) compared to mrigal (35.8 mgO₂/kg/hr). The actual average oxygen consumption has shown clear-cut downward trends from the surface via column to bottom dwelling fishes (Table 8.1. and Fig.8.1.). Species wise this trend was silver carp- 1060 g (58.2 mgO₂/ fish /hr) > catla- 680 g (48.0 mgO₂/ fish /hr) > rohu- 602 g (41.5 mgO₂/ fish /hr) > mrigal- 1095 g (39.19 mgO₂/ fish /hr) > silver barb- 425 g (21.25 mgO₂/ fish /hr) > common carp- 795 g (15.7 mgO₂/ fish /hr). After the computation, the carrying capacity of the

transportation tank at 1000 l was found to be 85-304 kg table size carps at 6 mg/l dissolved oxygen level. Different species of carps have different level of the oxygen consumption in the water. This corroborates the findings of Singh (1977) in case of carp fingerling. It is found that higher the biomass of fishes, lower the oxygen consumption as seen in case of silver carp (54.8 mgO₂/kg/hr) and catla (70.58 mgO₂/kg/hr). The overall oxygen consumption of carps (19.74 - 70.58 mg/kg/hr) was lower than mean rate of oxygen consumption (388.12 mg/kg/hr) of Indian catfish *Wallago attu* in nearly normoxic water (Chandra *et al.*, 1989). The fish weight and water volume ratio between the different species was 1:3 in *Cyprinus carpio* being the lowest and 1:12 in *Catla catla* being the highest (Table 8.3.). The lowest ratio was within the range prescribed by Mammen (1962), whereas, highest ratio was quite lower than that of the ratio recommended by Patra (1968). At high densities (0.5 kg/ l water), live fish can be transported for many hours by adding oxygen/aeration with control of water pH by addition of acid or raising CO₂ levels which in combination reduce the toxicity of the ammonia (Grottum, *et al.*, 1997). Being live fishes are more priced than dead fish, the tank is suitable for transportation of live fishes for better economic returns from marketing.

Table 8.1. Comparative study on oxygen consumption of carps during transportation in FRP tank

Species	Rohu	Catla	Mrigal	Silver carp	Silver barb	Common Carp
Water volume (l)	1000	1000	250	250	500	500
Fry stocked (nos.)	53	80	30	80	64	37
Total wt (kg) experimented	31.9	54.4	31.8	34	50.9	40.5
Size (average wt-g)	602	680	1060	425	795	1095
Initial oxygen (mg/l)	5.6	5.4	7.2	7.2	4.81	4.8
Final oxygen after 1 hr (mg/l)	3.4	1.56	0.22	0.4	2.8	1.9
Quantity of Initial O ₂ content in tank (mg)	5600	5400	1800	1800	2405	2400
Quantity of Final O ₂ content after 1 hr (mg)	3400	1560	55	100	1400	950
Oxygen consumed (mg)	2200	3840	1745	1700	1005	1450
Actual (mg O ₂ /fish/hr.)	41.5	48.0	58.2	21.25	15.7	39.19
Computed mg O ₂ /kg fish/hr.	68.9	70.58	54.8	50.00	19.74	35.8

Table 8.2. Physico-chemical parameters of experimental water

Parameters	Values in Range
Air temperature (°C)	32 – 38
Water temperature (°C)	30 – 34
pH	7.0 - 7.5
Free carbon dioxide (mg/l)	16 – 22
Total alkalinity (mg/l)	100 – 140
Ammonia (mg/l)	0.1 – 0.7

Table 8.3. Relationship between fish and water during transportation

Species	Size (g)	Ratio (kg:l)
<i>C. catla</i>	680	1: 12
<i>L. rohita</i>	602	1: 11
<i>C. mrigala</i>	1095	1:6
<i>H. molitrix</i>	1060	1:9
<i>P. gonionotus</i>	425	1:8
<i>C. carpio</i>	795	1:3

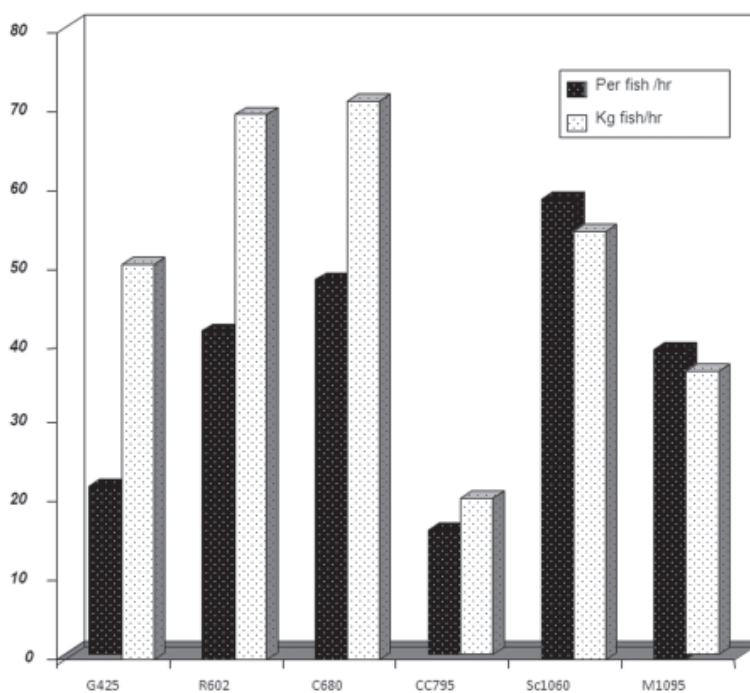
**Fig. 8.1. Oxygen requirement of table size carps**

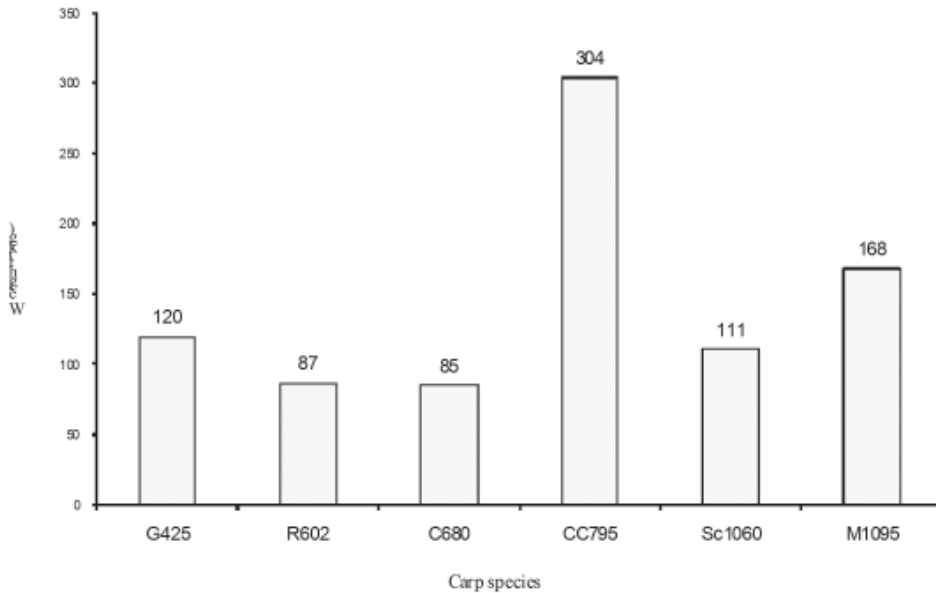

Fig. 8.2. Quantification of carps for transportation at full tank capacity

8.3. Experiments of Live Fish Fry Transportation

A preliminary fish seed transportation trial was conducted in PET transparent containers of capacity 6 l having airtight PP lids. Before placing into the container, fish fry were left in conditioning tank without being fed approximately for 15 hrs. The fish fry of average body weight 1.3 g were packed in the containers with 2 l of water and 4 l of oxygen. Fish seed was packed in three different densities *i.e.*, @ 100, 75 and 50 numbers, respectively per container. In second experiment they were packed @ 125 and 150 numbers per container. The containers were fitted with oxygen injection valves at the top of them, and at the bottom they had provision of regulated water collection for sample analysis. During experimentation, in every two hour intervals water samples were collected and measured for pH, conductivity, carbon dioxide, dissolved oxygen, water temperature, alkalinity and ammonia level. After 8 hrs of trial, the lids were opened and dead fishes were separated and counted for mortality rate. The fish fry mortality was recorded to be 6, 2.28 and 1%, in the containers stocked @ 100, 75 and 50 numbers, respectively. This was 30 and 6.24 % in the containers stocked @ 150 and 125 numbers, respectively.

How much DO an aquatic organism needs depends upon the species, its physical state, water temperature, pollutants present, and more. Consequently, it's impossible to accurately predict minimum DO levels for specific fish and aquatic animals. Numerous scientific studies suggest that 4-5 parts per million (ppm) of DO is the minimum amount that will support a large, diverse fish population.

Table. 8.4. Water quality during fish seed transportation in closed system (on 09.11.10)

Time Interval	Exp. No.	PH	Conductivity (mili mho /cm)	DO (ppm)	CO ₂ (ppm)	Temp. (°C)	Alkalinity (ppm)	Ammonia (ppm)
11:00 (Initial)		7.7	0.500	5.46	6.0	32.2	240	0.0041
13:00	A	7.3	0.491	5.3	11.0	32.8	230	0.0049
	B	7.2	0.492	5.8	9.4	33.0	240	0.0024
	C	7.4	0.488	5.1	8.4	33.0	280	0.0300
15:00	A	7.2	0.482	4.3	15.0	33.3	180	0.0899
	B	6.9	0.475	5.6	12.0	33.3	170	0.0585
	C	7.3	0.475	5.1	11.6	33.4	210	0.1116
17:00	A	7.0	0.487	3.8	18.0	33.3	140	0.0901
	B	6.7	0.484	5.6	13.5	33.3	160	0.0865
	C	7.2	0.481	5.0	12.0	33.3	170	0.0270
19:00	A	7.0	0.492	3.3	20.8	33.5	130	0.1109
	B	6.6	0.480	5.5	16.0	33.6	140	0.0939
	C	7.0	0.471	4.6	13.8	33.7	150	0.0843
21:00	A	6.9	0.474	3.0	22.8	33.7	90	0.2551
	B	7.8	0.480	5.4	20.6	33.7	110	0.1722
	C	6.4	0.496	3.8	16.0	33.7	130	0.1434
23:00 (Final)	A	6.4	0.507	2.6	24.0	33.8	80	0.2588
	B	6.3	0.493	5.2	21.8	33.6	110	0.1805
	C	6.7	0.498	3.0	17.2	33.5	120	0.1728

Stocking (nos fry /2 l of water)

A B C
100 75 50

Table. 8.5. Water quality during fish seed transportation in closed system (on 10.11.10)

Time Interval	Exp. No.	PH	Conductivity (mili mho /cm)	DO (ppm)	CO ₂ (ppm)	Temp. (°C)	Alkalinity (ppm)	Ammonia (ppm)
11:30 (Initial)		7.7	0.500	4.0	7.6	32.6	240	0.0041
13:30	A	7.5	0.581	3.0	14.0	33.3	150	0.0389
	B	7.6	0.498	3.5	11.9	33.3	160	0.0424
15:30	A	7.2	0.590	2.9	18.0	33.8	150	0.1725
	B	7.3	0.512	3.3	16.2	33.9	180	0.1088
17:30	A	7.0	0.536	2.0	20.0	33.7	190	0.2571
	B	7.1	0.509	2.9	15.8	32.4	160	0.1331
19:30	A	6.8	0.512	2.0	26.2	33.6	160	0.2588
	B	6.8	0.507	2.4	18.2	34.3	180	0.1946

Stocking (nos fry /2 l of water)

A B
150 125

Ammonia is toxic to fish and aquatic organisms, even in very low concentrations. When levels reach 0.06 ppm, fish can suffer gill damage. When levels reach 0.2 ppm, sensitive fish like trout and salmon begin to die. As levels near 2.0 ppm, even ammonia-tolerant fish like carp begin to die. Ammonia levels greater than approximately 0.1 ppm usually

indicates polluted waters. The danger ammonia poses for fish depends on the water's temperature and pH, along with the dissolved oxygen and carbon dioxide levels. Higher the pH and warmer the temperature, more toxic the ammonia is. Also, ammonia is much more toxic to fish and aquatic life when water contains very little dissolved oxygen and carbon dioxide.

Carbon dioxide quickly combines in water to form carbonic acid, a weak acid. The presence of carbonic acid in waterways may be good or bad depending on the water's pH and alkalinity. If the water is alkaline (high pH), the carbonic acid will act to neutralize it. But if the water is already quite acid (low pH), the carbonic acid will only make things worse by making it even more acid.

References

- APA, 1999-2001. *Annual Progress Report of AICRP on Application of Plastics in Agriculture*, CIFA, Bhubaneswar-751002.
- APHA-AWWA -WPCF, 1989. *Standard Methods for the Examination of Water and Wastewater*. American Public Health Association, New York, 1193 Pp.
- Basu, S.P., 1951. Effect of addition of soil in transport on larvae of Indian carps. *Proc. Indian Sci. Congr.*, **38**(3): 227
- Bhaumik, U., P.K. Pandit and B.K. Banerjee, 1986. Fin fish and Shellfish transport. In *Second National Fish Seed Congress*, Calcutta, July 3-4 1986: 99-101
- Chandra, S., S.K. Singh and S. Dasgupta, 1989. Rate of Oxygen consumption and determination of dissolved oxygen requirement for transport of freshwater shark *Wallago attu* (Schn.). In: *National Seminar on Forty Years of Freshwater Aquaculture* (Abs.), CIFA, Bhubaneswar, 7-9 November: SVE/ 14
- Das, P. and U. Bhaumik, 1979. Transport of live fish for stocking. *Souvenir in Commemoration of Golden jubilee of ICAR*, CIFRI, Barrackpore, Part-1: 64-68
- Gupta, M.V. and B.K. Sharma, 1974. A note on the transport of Chinese carp breeders using MS 222. *J. Inland Fish. Soc. India*, **6**: 99-100
- Grottum, J.A, M. Staurnes and T. Sigholt, 1997. Effect of Oxygenation, aeration and pH control on water quality and survival of turbot, *Scophthalmus maximus* (L.) kept at high densities during transport. *Aquacult. Res.*, **28** (2): 159-164
- Hora, S.L. and T.V.R. Pillay, 1962. Hand book on fish culture in Indo- Pacific Region: *FAO Fish. Tech. Pap.*, **14**: 204p
- Jhingaran, V. G., 1975. *Fish and Fisheries of India*. Hindusthan Publishing Corporation (India), Delhi: 954 Pp.

- Jhingaran, V.G. and Pullin, R.S., 1985. A hatchery manual for the common Chinese and Indian major carps. *ICLARM Studies and Review*, **11**: 141.
- Mammen, T.A., 1962. Live fish transport using modified splash less carriers with compressed aeration. In: *Training course on live fish transport organized at Hyderabad Fisheries Extension unit, Govt. of India*. 19-21 November, 1962.
- Ou, -youjum and Li, -Jia'-Er., 1996. Test on the transportation of live parent mullet. *J. Mar. Fish. - Haiyang- Yaye*, **18**(1): 8-12
- Patro, J.C., 1968. A note on a new fish carrier, double barrel types (Mimeo): 6p.
- Ramachandran, V., 1969. Transport of fish spawn, fry, fingerlings and breeders. In: *FAO/UNDP Regional Seminar on induced breeding of cultivated fishes held at Calcutta, Cuttack and Bombay from 15 July-18 August, 1969 FRI/ IBCF*, **16**: 28p
- Ramachandran, V., 1972. Short and long distance transport of live fish for stocking. *Souvenir Silver Jubilee CIFRI, Barrackpore*: 45-48
- Selvaraj, C., A.N. Mohanty and S.R. Ghosh, 1981. Preliminary observation on the transport of fish fry under air pressure. *J. Inland Fish. Soc. India*, **13**(2): 75-79
- Singh, B.N., 1977. Oxygen consumption and amount of oxygen required for the transport of rohu and mrigal fingerlings. *J. Inland Fish. Soc. India*, **9**: 98-104.

PLASTIC PACKAGING FOR FRESHWATER FISH PROCESSING AND PRODUCTS

B.B. Sahu, Usha J. Maji, S. Mohanty and B.C. Mohapatra

9.1. role of Plastic Material in Packaging

Quality assurance is essential in each technological process, and suitable packaging materials and methods are of great importance for freshwater fishes. If these requirements are not met, all efforts made during processing could be of little avail which could lead to serious economic losses. Packaging should protect the product from contamination and prevent it from spoilage and at the same time it should:

- extend shelf life of a product,
- facilitate distribution and display,
- give the product greater consumer appeal, and
- facilitate the display of information on the product.

9.2. Fresh Fish Packaging

The quality of freshwater fish which is delivered to the consumer or the processing plant as live fish greatly depends on correct handling during transport and, when processed needs suitable packaging. For short distances, the live fish can be transported in insulated containers with lids. Fish can also be transported in normal lorries, but for long distances the water in the containers must be aerated and cooled by portable devices.

In order to maintain good quality of fresh fish during transportation, fish boxes made of suitable materials should be used. When purchasing fish boxes, the six following requirements should be remembered; they should:

- be of a suitable size for the range of fish to be handled or the product to be put into them
- be of a convenient size for manual handling or lifting by mechanical equipment
- be stackable such that the weight of the containers on top rests on the containers underneath and not on the fish
- be constructed of impervious non-staining materials
- be easy to clean
- provide drainage for melted ice

Fish boxes are usually made of high-density polyethylene. Although this offers many advantages, such as duration, lightness, ease of cleaning, there are also disadvantages, *e.g.*, high price and the fact that they are not returnable. That is why disposable fish boxes of about 25 kg capacities (fish and ice) are more often used. These include fiberboard cartons, waxed and waterproof boxes. In the case of transport by lorries with no cooling system, insulated cartons, *e.g.*, boards made of molded polystyrene are preferred. The latter is commonly used for delivery of chilled and frozen fish and fish products to wholesale and retail outlets. In the case of fillets, each layer of fillets should be packed thin and separated from the ice with a plastic foil.

9.3. Styropor Boxes

Styropor boxes are normally sold with lids, which fit very closely and can be with or without drainage holes. In a typical range, wall thickness varies with box size; *e.g.*, a 6 kg capacity box has 15 mm thick wall, 10 kg box has 19 mm wall and 25 kg boxes has 25 mm wall. The main disadvantage of moulded polystyrene fish boxes is lack of strength. They are easily damaged or broken by rough handling. This limits their size and use.

Polystyrene is difficult to clean re-use and are usually non-returnable. They may cause disposal problems due to their bulk. The packaging industry improves its products by using new materials with better insulating properties or by introducing new leakproof designs. The new containers are often lighter and less bulky. For example, the Therma Guard packing system consists of a metalized plastic bag (which reflects practically all radiant heat). This is then wrapped in a waterproof and leak proof carton. The metalized bag, together with a bubble-pack wrapper, provides double-pack insulation. The Therma Guard bag can be sealed airtight and thus be used for carrying live fish. The Stratech aluminized boxes have a wall thickness of only 5 mm and it is claimed that these boxes have similar insulating characteristics as polystyrene boxes with 30 mm wall thickness.

9.4. Retail Packaging for Freshwater Fish Products

The main role of packaging is described above, but in respect of retail presentation it should also reduce the smell and the drip, and enable the product to be tucked into shopping baskets with other purchases. Moreover, the packaging of fish products should ensure attractive presentation among other food products without contaminating them. Basic packaging materials include paper, cartons, sheets of metal, metal foils and many kinds of plastics. Despite the rapid growth in use of plastics, the role of paper and carton as packaging materials does not decrease. Kraft paper or carton is often laminated with polyethylene or aluminium foil which renders them waterproof. Such material is used for production of trays for packaging of fresh or frozen products. More often, trays are made of plastic materials such as polystyrene or expanded polystyrene. Expanded polystyrene is frequently used, but it is partly oxygen-permeable and so

those products which are sensitive to rancidity have to be additionally overwrapped or skin-packed with suitable film. The materials mentioned above are not stable at high temperatures and hence are not suitable for trays to be used in an oven. Polyester can be used as a packing material for heating of the product in the traditional and microwave ovens, but this material cannot be used for microwave cooking.

9.4.1. Trays Used for Packing

Trays used for packing are generally overwrapped with a protective film, often with PE wrapping which shrinks. The film shrinking is achieved by use of hot air or hot water. Stretch wrapping is often used for products which are heat-sensitive. The film is stretched over the product manually (very often in the supermarket) or by machine. Foils used as wrapping or bags for packing of trays with product must be puncture-proof, extensible and impervious to gases like oxygen.

9.4.2. Films Used for Packing

Hundreds of different films are used in the packaging industry. These can be broadly categorized into two groups:

- basic films consisting of a single layer of film
- laminate consisting of two or more basic films glued together or bonded together by heat or by adhesives

Plastics such as polyethylene film or copolymer of ethylene and vinyl acetate are very often used for packing of frozen products. Polyethylene packs can be produced manually using pre-made bags. An impulse or bar sealer is used to seal the bags which are hand-filled.

9.4.3. Vacuum and Modified Atmosphere Packaging

In order to improve the barrier properties of packages, laminates are used, for example polyester/polythene. Products which are particularly sensitive to oxygen are vacuum-packed. During the sealing operation, air is removed from the package. A laminate nylon/polythene is commonly used as packaging material. This type of packaging is used, for instance, for smoked trout which are arranged on a board with, for example, a coated texture. Numerous machines exist for vacuum-packing with single, double or continuous chambers. Vacuum-sealing machines can additionally be equipped with a modified atmosphere packing system (MAP). Immediately on removing the air from the package a mixture of gases is pumped in. Usually this mixture consists of 30% nitrogen, 40% carbon dioxide, and 30% oxygen. In the case of fat fish the oxygen is replaced by nitrogen. This method is increasingly used for packing fresh fish. The MAP products have to be stored at the temperatures lower than 3 °C because of *C. botulinum* hazard. MAP packages consist of two kinds of foil. The bottom film is foil-rigid or semi-rigid. This foil is formed by, for example, extrusion and the resultant tray is moved

to the packing section. Because of product drip it is placed on an absorbing board. The top web is drawn over the filled trays and sealed round the edges. The pack may be evacuated or gas-flushed before sealing. Vacuum-skin packaging is becoming more common for packing smoked fish. In this process the wrapper is heated and wrapped over the product, the film moulding completely to the product shape and sealing the product completely, forming an extra skin.

9.4.4. Evaluation of Polyethylene, Polypropylene and Laminated Polypropylene Packaging Material in Fish Retailing

PE, PP and laminated PP packaging materials were evaluated at CIFA, Bhubaneswar. Rohu and catla fish chunks were treated with Spice mix Nisin and pro-biotic cultures like *L. casei*, *P. pentosaseus*, *L. bulgaricus* and *S. thermophilus*. All the treatments successfully enhanced the keeping quality of the fish patties up to 12 days at chilling (5 ± 2 °C) and up to one months in freezing (-20 ± 2 °C). Fish flesh mixed with 20% fish gel of same species produced even better keeping quality *i.e.*, 15 days under chilling and 2 months under freezing.

Vacuum packaged products and modified atmosphere packages produced similar results in enhancing the keeping qualities. PE, PP and laminated PP packaging materials were evaluated. Laminated PP packaging materials were found to be most suitable for both vacuum packaging and MAP. Both the products *i.e.*, ready to eat and ready to cook fish patties showed the enhanced keeping quality during chilled and frozen conditions. Keeping quality of the product was found unaltered even after 3 months of frozen storage.

9.4.4.1. Evaluation of Polyethylene Carry Bags for Fresh Whole Fish (Indian Major Carps)

Indian major carps (Rohu, Catla and Mrigal) of size 1 to 2 kg were packaged in 70 cm into 25 cm polyethylene carry bags (200 microns). The carry bags were provided with windows for easy carrying. Fresh whole fish after thorough washing were packaged individually in carry bags. This packaging provided a hygienic look to the product and was helpful during fish chilling and during chilled display. Chilled fresh whole fish in carry bags maintained the quality for 36 hours, after harvesting to whole fish retailing. Information on date of harvest, fish species, weight and direction for use, etc. were mentioned on the carry bag. This method was found to be suitable for fresh whole fish marketing.

9.4.4.2. Evaluation of Polypropylene Containers with Lid for Retail Marketing of Fish Cut-up Parts During Chilled and Frozen Storage

Round poly propylene rigid containers with lid having 500 micron thickness were used for packaging of fish cut-up parts, fingers, chunks, nuggets were hygienically packaged in round containers and were either chilled or frozen and displayed for

retailing. Chilled products and frozen products maintained quality for 7 days or 3 months respectively.

9.4.4.3. Evaluation of PET Bottles for Packaging of Fish Pickle

Trial was under taken to study the keeping quality of the pickle (*Murrel* and *Anabas*) in PET bottles, 500 ml and 250 ml capacity. Pickled fish product maintained the keeping quality in optimum condition for 6 months under chilling and ambient storage. The final product pH was found to be in the range of 3.4 to 3.6 and the pH was stabilized after 15 days of production. Wide mouth PET bottles have been found as a suitable alternative for glass bottles in maintaining quality of the pickles up to one year successfully.

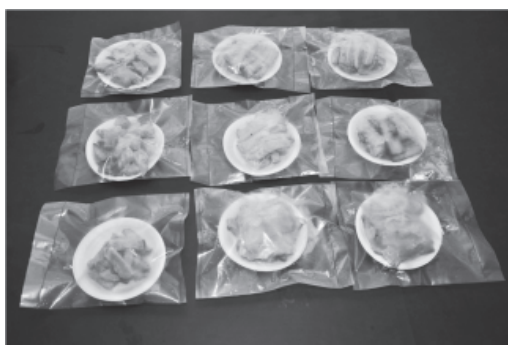

Packaging of fish cut-up parts



Whole fish packaging

9.5. Labeling Requirements for Freshwater Fish Products

Lack of detailed standards and existence of only limited regulations concerning wholesomeness and sanitary conditions for production and trade of food products characterize the market economy. Here, the problem of labeling is of a particular importance. Regulations in this regard are very detailed and are aimed at protecting the health of the consumer and providing the best information. These requirements enable the consumer to decide which products to buy. A label placed on the product should inform the consumer about the raw material used, method of preparation and form of consumption, shelf life, etc.

9.6. Significance of Microbial Growth, Activities and Safety

Modified atmosphere packaging (MAP) extends shelf-life of most fishery products by inhibiting bacterial growth and oxidative reactions. The achievable extension of shelf-life depends on species, fat content, initial microbial population, gas mixture, the ratio of gas volume to product volume, and most importantly, storage temperature. The shelf-life of fishery products is usually limited by microbial activity, although for some fatty fishes or at super chilled storage, it can be limited by non microbial activity. Packaging of fishery products under modified atmospheres (MA) increases shelf-life

compared with those packaged under air, but confers little or no additional shelf-life increase compared with vacuum packaging. The specific spoilage organism (SSO) of MA packaged cod at 0 °C has been found to be *Photobacterium phosphoreum*. Whether or not this bacterium is the general SSO for all marine temperate fishes at different storage temperatures and under various CO₂/N₂/O₂ mixtures needs to be resolved. Without proper control of storage temperature, the benefits of MAP may be lost. Higher temperatures inevitably lead to less dissolved CO₂ in the product and consequently loss of inhibitory effect, which may result in higher microbial and enzymatic activity, and uncertainties concerning the microbial safety, as food-borne pathogens might be present in the product.

9.7. Conclusion

MAP in fish processing is most commonly applied to packs for retail sale. Typically the containers are made, and the product loaded and sealed, in a multistation machine. A semi rigid tray is formed in the machine from a web of thermoform plastic. The tray is flanged and is ribbed to enhance its rigidity. The product is loaded into the tray and trays pass in batches to the vacuum and filling station, where the air is exhausted and replaced by the gas mixture. The trays, still in the chamber, are sealed by the top film and then released. The packs can be labeled with stick-on labels or can be inserted into sleeves printed with the information. The plastics films need to be selected for the purpose. The lower film needs to be thick enough to give a sufficiently rigid tray, and the upper film strong enough to withstand puncturing during normal handling. Both films must be resistant to diffusion of the gases, particularly the carbon dioxide, CO₂, which is critical for extension of storage life, though complete resistance is not required for the few days of storage of MAP packs. Selection of appropriate films is a specialist area of packaging technology and the manufacturer of the packaging machinery will be able to advise.

It has been known for a very long time that CO₂ inhibits the growth of spoilage organisms on meat and fish and MAP seeks to take advantage of this fact. The greatest inhibition is given by 100% CO₂ atmospheres, but it is not possible to use this concentration in practice. CO₂ dissolves in the fish flesh, so that the volume of gas in the pack decreases and the packs collapse. High concentrations of CO₂ have other undesirable effects on sensory attributes such as excessive drip loss, dulling of appearance and a slight 'sparkling' sensation in the mouth when eating the cooked product. Too low a CO₂ concentration to avoid pack collapse and the other effects provides no inhibition of spoilage and the compromise is to use between 40% and 60% CO₂, more often 40%. The remainder can be nitrogen or nitrogen and oxygen. It is advisable to pack at a slight overpressure to allow to some extent for solution of CO₂ in the fish. The ratio of gas to fish needs to be around 2-3:1, that is, for a 250 g pack, the volume of the tray should be at least 750 ml. This high ratio is required to provide

sufficient inert gas to avoid pack collapse and sufficient CO₂ to exert an effect. This high ratio of pack volume to product weight is a disadvantage of MAP, because of the considerably increased volume of storage and carrying capacity required compared to other forms of packaging.

It has been suggested that fatty fish should be packed in an oxygen-free atmosphere to reduce development of rancidity, but it is difficult to demonstrate this effect in practice over the typical storage times of MAP products. Contrary to this, it has been suggested that oxygen should be included in the gas mix to reduce the risk of development of botulinum toxin. It is not possible to be certain that fish do not contain spores of *Clostridium botulinum* and exclusion of oxygen favours growth of the spores and formation of toxin. This hazard has been extensively studied for a variety of gas mixes and fish products, and the risk seems to be very small indeed, and no different from other forms of packaging of fishery products.

There is no doubt that CO₂ inhibits growth of spoilage bacteria, but the recorded extension of storage life of MAP products depends on the criterion used to judge end of storage life. Almost all reports on studies of storage life use a criterion of unfit for consumption that is equivalent to about 14 days in ice for air-stored gadoid such as cod. However, MAP product are intended for retail sale in supermarkets and they use a fresher criterion of end of storage life of presence of some fresh flavours and absence of any spoilage flavours, equivalent to about 7-8 days in ice for air-stored gadoids. With this criterion, MAP in CO₂ provides no extension of storage life because CO₂ has no effect on the biochemical reactions resulting in loss of intrinsic fresh flavours.

Even when unfit-for-consumption criteria are used, any extension of storage life by CO₂ is difficult to achieve in practice. The most important factor is temperature of storage. The effects of CO₂ in extending storage lives are greatest when the product is stored at 0°C, and are negligible above about 5°C. Typical ambient temperatures around products during distribution of fish in the chill chain around 2°C, and temperatures of chill display counters in supermarkets are typically around 4°C.

References

- Franzetti, L., S. Martinoli, L. Piergiovanni and A. Galli, 2001. Influence of active packaging on the shelf-life of minimally processed fish products in a modified atmosphere. *Packaging Technology and Science*, 14(6), 267-274.
- Gopakumar K., 1993. *Fish Packaging Technology: Materials and Methods*. Concept publishing company, New Delhi.
- Katarína Hudecová, Hana Buchtová, Iva Steinhauserová, 2010. The effects of Modified Atmosphere Packaging on the microbiological properties of fresh common carp (*Cyprinus carpio L.*). *ACTA VET BRNO* 2010, 79: S93-S100.

- Maji U.J., 2010. Effect of biopreservatives incorporated fish dispersion on the keeping quality of *Labeo Rohita* & *Catla catla* fish patties under different packaging conditions. Thesis submitted to O.U.A.T., Bhubaneswar for the partial fulfillment for the degree of M.Sc. microbiology.
- Sivertsvik, M., W. Jeksrud and J. Rosnes, 2002. A review of modified atmosphere packaging of fish and fishery products - significance of microbial growth, activities and safety. *International Journal of Food Science and Technology*, **37**(2), 107-127.

SOCIOECONOMIC CONTEXT OF IMPACT OF PORTABLE HATCHERIES IN INDIA

Nagesh Kumar Barik

Aquaculture as a tool for agricultural growth, nutritional security and rural development has gradually been recognised. Increasingly, the contributions of the aquaculture to the national food and livelihood security are getting its due place. The fish farming has become the fastest growing food producing sub-sector in the world and today some 90% of aquaculture production takes place in developing countries (FAO, 2004). Positive impact from aquaculture production can arise at different levels viz., i) higher productivity, income and better livelihoods at the producer level, ii) increase supply of fish and a reduction in prices at the consumer level, and iii) increase in trade and export of fish as well as employment generation that benefit overall development (Ahmed and Lorica, 2002, Dey *et al.*, 2006). The real development of the aquaculture sector in India started from late seventies and from then the sector has been grower faster and steadier. From the onset of the green revolution, the agriculture sector grew at about 2.36 % (Bhalla and Singh, 2009), but the aquaculture growth was remarkable at about 6.2 % per annum. During this period aquaculture production in India increased from 0.2 MT in 1973 to 3.48 MT in 2008 (FAO, 2010). The intense process of the technology generation, dissemination and development initiatives is the core of the aquaculture transformations. Over last 40 years a large numbers of the aquaculture technologies are being developed and disseminated to the farmers. Among them, the seed production technology is prime driver of the aquaculture development in the country. The seed production technology consisting of induced breeding, seed rearing and culture technologies consisting of combining compatible species, creating conducive environment for growth, feeding, etc. are being perfected. For aquaculture, the seed is the most basic requirements and till today, it is still considered as constraints to the large part of the country. Various technological options are being provided for seed production and latest among them is being the Portable Carp Hatchery, which holds the promise to provide seed even to the small farmers at the remote locations of the country. The technology has been widely adopted across the country since last 6 years. The present chapter gives an impact assessment perspective to the technology. It presents the basic issues and observations and considerations in the impact assessment of the technology in coming times.

10.1. Historical Perspective of Seed Production System in India

The aquaculture starts with the availability of the seed for it. Before the modern technology based aquaculture, the fish farming was a tradition in the eastern part of the country. The flooded zones on the eastern India act as breeding ground for the fish. After recede of the rainwater, the small isolated water bodies forms the refuge for the fishes which consequently harvested by the people after certain period. This system is the beginning of the aquaculture as subsequently people stocked mixed seeds collected from the natural sources so as to be harvested when required. This traditional system of the aquaculture existed in the country since centuries (Pillay & Kutty, 2005). But, the system did not make much headway as these seeds were mixed in nature without any certainty of species, sizes and timely availability. A lots of research attention are being given to collect the eggs and seeds from the natural sources as cultivable carps seeds are available in the natural riverine system. These constraining conditions constituted major bottleneck to the aquaculture development. Various experiments and innovations were being made to improve the seed production by collection of fertilised egg from natural waters as well as breeding fish for the seed in captivity (For details see ICAR, 2006). But all these attempts were not sufficient to supply the huge demand of the seed in the country. The major breakthrough occurred when Dr Hiralal Chaudhury and Dr K. H. Alikunhi were able to breed the fish in confined water in 1957. From this date the experimentations, innovations and refinements lead to many systems of the breeding and seed production in the country. Among them the circular hatcheries have been established as most feasible and reliable technology for carp breeding in the country. Along with the development of the technology for seed nursing and rearing, a full proof system of carp seed production has been developed in the country. Over the period of time, there have been improvements in the spawning and nursing technology. The Portable hatchery is the new innovation with the aim to make whole hatchery system portable at reduced cost. Since 2006, the technology is creating major impact by rapid adoption across different parts of the country. The contributions of the technology to the seed production sector are quite significant.

As per fish seed committee, India produced 20.45 crores seeds in 1964-65 which increased to 75.2 crore in 1980-81 (IIM, 1985), during this period the seed sector met only 48% of the requirements. Many programmes like National fish seed programme, World Bank programme, Fish Farmers Development Agencies (FFDA) programmes are being initiated to produce sufficient seed for the aquaculture. As more and more of the water bodies are brought under aquaculture, hence the demand for the fish seed was growing in an exponential rate. In every states the efforts are being made to establish the seed production system to produce seed. In the initial stage, the seed

production has been under the public sector. The centrally sponsored schemes like National Fish Seed Programme (25 seed farms with 250 ha), World bank Programme (27 farms with 435 ha), FFDA programme (45 seed farms with 225 ha) were being launched to develop fish seed capacity in the country. Hence by 1980 about 900 ha of seed farms are being developed in the country with a total rearing capacity of 941 million seeds. This is the case when the pond area under culture was only 1.55 lakhs ha in 1980-81.

But from then onwards, the rapid expansion of the fish seed sector was observed with the present production of about 25,000 million fry being produced each year. The curve below shows the rate of expansion of the fish seed sector in the country. It has an average growth rate of 5% in last 25 years.

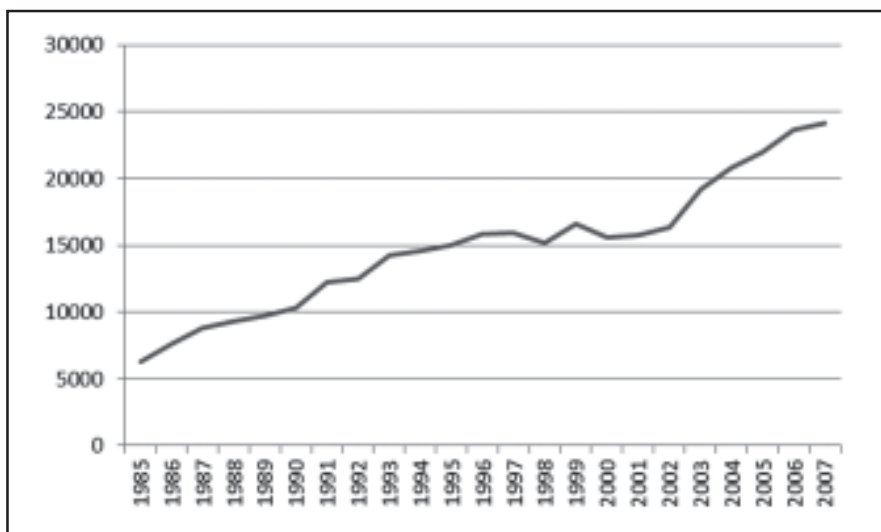

Fig 10.1. Seed production trend (in million fry)

Till today the aquaculture development has been concentrated in the water rich and irrigated regions of the country. Most of the rainfed regions and hilly states don't share the high growth of the aquaculture development in the country. These areas lagged behind in the country due to shortage of the seed in the regions. About 56% of the seeds are being produced by the state of West Bengal. About 82% of fish seed is being produced by five states i.e., West Bengal, Andhra Pradesh, Assam, Odisha, Bihar and Uttar Pradesh. These states are concentrated in the eastern part of the country. Traditionally the fish seeds were available in these parts, but in the recent times, many other states are trying to produce seed. For them, the portable hatcheries technology is a suitable and affordable technology. With more decentralisation of the fish seed production, the smaller hatcheries are becoming more popular among the operators.

Therefore, the portable hatchery has become a popular technology among the non-traditional seed producing states.

Table 10.1. Relative share of production and seed production

	Inland fish production	Seed production
WB, AP	48.3	59.8
AS,OR,BH, UP	26.1	22.2
Hill states	2.3	6
Other coastal states	10.2	6.7
Other states	13.1	5.3

10.2. Research and Development of FRP Hatcheries in India

Banking upon the induced breeding techniques, many innovative packages of practices were evolved over a period of time to produce seed. Initially, the breeding of carps, hatching of eggs and rearing of hatchlings up to spawn stage were carried out in different rectangular hapa made up of cloth. They were fixed in the pond for clear oxygenated water. In hapa system, the entire operations were weather dependent and subject to various environmental hazards. During seventies, glass jar hatching units of various capacities were designed and made to use successfully for hatching. The system had its own drawbacks for commercial seed production. During eighties, the carp eco-hatchery technology got familiar in India. During nineties, different models of hatcheries with different materials (HDPE, PVC, LDPE liner, Ferro-cement, etc. in various shapes and sizes) came to the existence with certain degrees of success at research level, but, they could not penetrate to the grassroots levels (Mahapatra *et al.*, 2008). Till today the dominant system of the hatchery has been the circular cemented one also known as Chinese circular hatchery. But, the hatchery suffers from the limitation of the fixed in nature, requirement of high cost and land, specialised knowledge in designing and construction, etc. To get away with these limitations many alternative materials were being contemplated. One of such is the use of plastic tank by KVK, CIFA to breed carps in the year 1989. The present technology of AICRP on APA was new innovation and proved advantage to conventional system owing to low cost, easy maneuverability, elimination of overhead tank with electric pump, use of recycled water from pond. Initially 1.5 million egg (70 litres) hatched with efficiency of 70-86% in a hatchery of 2.27 m³ (CIFA, 1989-90). This success has provided sufficient clue to do systematic research on the material and design using plastic for hatchery structure.

The All India Coordinated Research Project on Application of Plastics in Agriculture (ICAR), Centre at CIFA, Bhubaneswar started in the year 1988-89. Under the project specialised workshop and capacity was developed to produce various plastic materials

to be used in the aquaculture sector. Among many applications, the research on the developing plastic hatchery is most important. It has designed and developed the complete set of hatchery system in FRP for carp fish breeding and hatchery rearing of seed (Mohapatra *et al.*, 2003; 2004; 2005 & 2008) as a product of about 15 years of research. After numerous experiments, the technology was commercialised in the year 2006. After which the technology was disseminated throughout the country.

10.3. The Technology Package

The portable hatchery is a complete set of the plastic structures for the spawn or hatchling production from matured fishes of carps. The system is similar to cemented hatchery except that all the materials are made up of plastics. The complete hatchery unit is made in four parts for easy transport, installation, dismantle and repair. The components of the hatchery are (i) Breeding/ spawning pool, (ii) Hatching/ incubation pool, (iii) Egg/ spawn collection chamber, and (iv) Overhead storage tank/ water supply system. The whole system can be installed in any plane or raised platforms. It has several merits like easy for transportation to different farm sites, easy installation and operation, low water consumption during fish breeding and spawning, easy to repair, less space requirement for installation, less weight and durability of the product for 10-15 years. In recent times several inducing agents for fish breeding is available. Newly developed FRP hatchery coupled with easy availability of hormonal products makes the carp seed production easy in the remote and rural locations. In lean season the system can be used for ornamental fish rearing or common carp breeding or water storing (Mahapatra *et al.*, 2008).

A standard hatchery unit consists of one breeding pool associated with one hatching pool. In this hatchery the spawn (final product from hatchery) is harvested on 4th day during operation. The fertilized eggs are kept in hatching pool for incubation and it takes 14-18 hours for hatching, and then after 72 hours for transformation to spawn. Thus, four days are required for spawn production from one million capacity unit. If it has two hatching pool then the second operation of spawning can be done when the second hatching pool is available *i.e.*, one day gap is required in every two days of spawning operation. In case of three hatching pool, the spawning can be done every day. In one operation it can produce 1.0 - 1.2 million spawn. In a season minimum 20 operations can be made and it can go upto 60 operations at its maximum capacity. In each cycle about 20 kg of brood fish is required at the equal ratio of male and female.

The average cost of the FRP hatchery with one hatching pool is about 1 lakh. The total cost of material as well as installation including pump, shed is about 1.5 lakhs. For each operations about Rs 3000 is required per operations. In each operations about Rs 6000 to 8000 of spawn can be produced at the price of Rs 600 to Rs 800 per lakhs. It is expected that the capital cost of the hatchery can be recovered in 2 to 3 years depending upon actual number of the operations made.

10.4. Operational strategy

Technically, the advanced fry or fingerlings of 25-40 mm size carp seed with the age of about 45 to 60 days is considered as seed and to attain the such size three to four stages are involved. The following details of the processes of seed production are required involving FRP hatchery.

Table 10.2. Stages of seed production involving one FRP unit in one operation

Stages	Period	Quantity inputs	Quantity output	Ideal unit size	Total size
Broodstock to egg	1 day	10 kg female + 10 kg male	10-12 lakh egg		
Egg to hatchlings	3 days	10-12 lakh egg	8-10 lakh spawn		
Spawn to fry	20 days	8-10 lakh spawn	3 lakh fry	0.05- 0.1 ha	0.2 ha (2-4 nos of pond)
Fry to fingerlings	60-90 days	3 lakh fry	1.5 lakh fingerlings	0.2-0.5 ha	1 ha (2-5 units)
Fingerlings to table size	250-300 days	1.5 lakh	75- 100 tonnes	0.4 ha and above	30 ha (75 units)

The FRP hatchery can be operated for about 20 cycles in a year and in each operation details of the requirements are presented in the Table 10.2. It is being seen that each operations can provide seed to about 30 ha of culture area with the involvement of the seed rearing area of about 1 ha area. A typical development model for the use of the FRP hatchery for the aquaculture development is presented below. The potential of the technology to generate the social benefits is also quite high as in each operations even upto 80-90 household can get benefits.

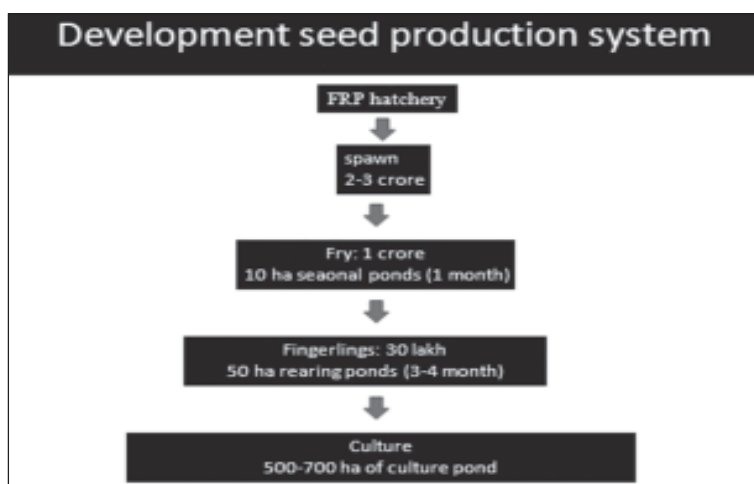

Fig. 10.2. Model for the development of seed production system with FRP hatchery

6.5. Dissemination of the Technology in India

The five years is quite a small period for assessing success of any technology. But within a short span of time, the dissemination has been quite remarkable. Presently 126 sets of the hatchery have already been established across the country. In the year 2010-11 as high as 44 sets are being established across the country. Cumulatively, the growth rate is very fast with each passing year as indicated from the sharp rise in the curve (Fig. 10.3.). There is growing confidence of the technology adopters from the date of commercialization of the technology.

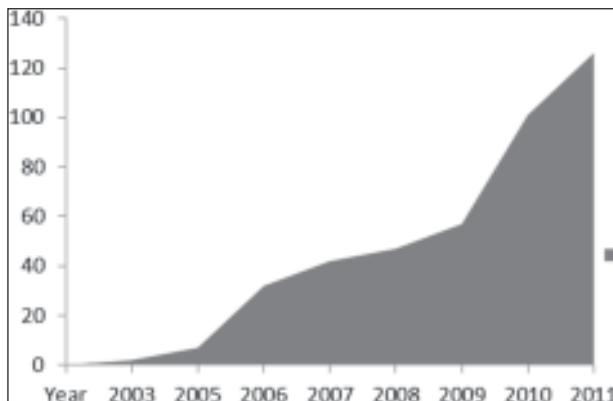

Fig. 10.3. Cumulative growth of portable hatchery units in India

Geographically, every region of the

country has been touched upon. The eastern region which is the traditionally aquaculture rich region is also the largest beneficiary of the technology accounting to 46.7 % of the installations (Fig. 10.2). Northeast is next important region to which the technology has penetrated as now most of the hilly states are being able to produce seed through establishment of the portable hatchery. The other regions of the country are also getting benefit from the technology as evident from growing demand in these parts.

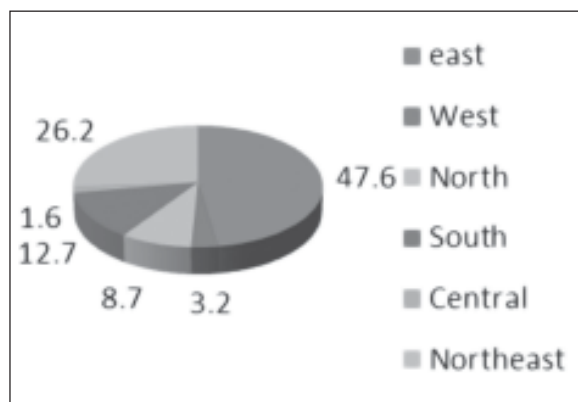

Fig 10.4. Dissemination of portable hatchery technology across the regions

The beneficiaries and end users of the technology are very diverse. Most important end-users are the KVKs and regional centres and headquarters of

ICAR institutes, SAUs and Universities where the expertise for operating the hatchery is available. The state governments in many states have established in their own state to produce seed for their region. Few NGOs like Ramakrishna Mission, Sahavagi Bikash Abhijan, West Utkal Agriculture centre, HESCO are producing large numbers of seed to supply to the nearby localities. The corporate houses like Amalgamated Plantation Private Limited (A unit of Tata Tea) have come forward to produce seed for their own requirements. But, the most important end-users are the individual entrepreneurs

who run the hatchery for commercial purpose and they are able to generate income to sustain their family. Therefore, the hatcher technology is giving benefits to all sections of the society.

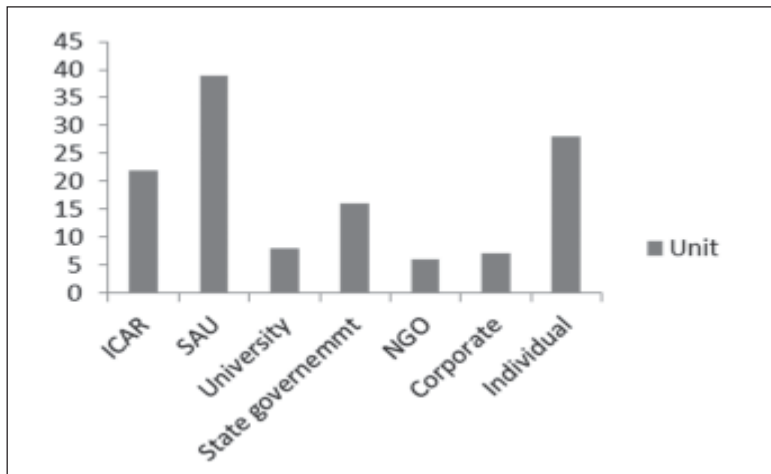

Fig 10.5. End-users of Portable hatcheries

10.6. Domains of Adoption

The technology packages of fish seed production inclusive of broodstock raising, hatchery and seed production were initially adopted widely in the West Bengal and spread rapidly to the many coastal places like Odisha, West Bengal, Andhra Pradesh, Assam. Among them West Bengal continue to be the dominating player in the seed production in the country. In general, the seed production is very popular in the eastern coastal regions, where freshwater is abundant. These regions are not only surplus in the fish seed production, but also provide seed to many other interior and relatively seed scarce regions like rainfed regions. The coastal regions also suffer from the constraints of the abundance of the natural predatory fishes like murels and catfishes which influx into the seed production system through flood water. The flood is a major constraint. In some of the other plain areas, where the water is abundant but the seed production system are not predominant like Indo-genetic plains and terrai belt, where aquaculture is not a popular enterprise, nor, they suffers from problems of flood. In compared to costal and plain regions where water is abundant, the areas like hilly region rainfed regions are suffers from limited aquatic resources for aquaculture purposes. In many cases the rainfall are high but for the limited period. In the hill regions even through rainfall is high, they suffers from limited suitable land for creation of the water bodies. Where as in case of the rainfed areas there are many different categories of water resources like small, large, seasonal, perennial categories. In these water bodies the possibilities of the aquaculture are being explored due to the economic

opportunities in integrating aquaculture use in the existing multiple use water resources. Therefore, a growing attention to develop aquaculture in the hilly as well as rainfed areas is creating demand to develop seed production in these regions. In all of these categories of the regions can be treated separated in terms of the operational, strategic and policy perspective. The salient features from the regions in the perspective of the FRP hatchery technology is as below (Table 10.3.).

Table 10.3. Domains of adoption for FRP technology

Characteristics	Coastal and flooded Plains	Non flooded plains	Rainfed areas	Hilly
Aquaculture	Well developed	Partially developed	Under developed	Under developed
Seed availability	High	Medium	Low	Scarce
Resource constraints	Flood	None	Drought	Land scarce
Environmental conditions for hatchery	Suitable	Suitable	High temperature	Low temperature
Linkages to seed growers, broodstock raiser	Well developed	Partially developed	Under developed	Under developed
Preferred species	IMC	IMC, exotic carps	IMC, minor carps	Exotic carps
Seed market development	High	Partially	Low	Under developed
Competition to the FRP hatchery operator	High	Medium	Low	Low
Major constraints in seed production	Flood, competition	None	Technical knowhow	Technical knowhow

Therefore, the four clear adoption zones are there for the Portable Hatchery. Till the year 2011 all the zones have been received the hatchery. The relative distribution of the hatcheries in these zones are as below.

Table 10.4. Zone wise distribution of portable hatchery in India up to 2011

Zone	No of hatchery unit	Percentage
Coastal flooded	42	33.3
Plain	20	15.9
Rainfed	44	34.9
Hilly	20	15.9
	126	100.0

Among the four adopted zones the maximum numbers of the hatchery are being taken to the rainfed areas. The rainfed areas are seed scarce region as seeds are being available at the distant places and constitute most important constraints to aquaculture. The hatcheries are being used to supply the seed at the earliest so as to stock the seasonal as well as perennial water bodies quickly after rain. The coastal and flooded zones also constitute the important adopted zone for the technology. In the coastal zone, there are many seed producers but the portable hatchery can be operated within a small space and sufficient to the smaller scale operations in commercial scale. In the hilly regions, many of the hatcheries are being used to breed exotic carps. But the important constraints in the hill areas are availability of the broodstock and rearing space. The other plain regions are the important beneficiary of the project as the aquaculture is rapidly expanding in these areas and the hatchery is being able to put in good use.

10.7. Policy Context of Adoption of Portable Hatchery

The wide scale disseminations of the portable hatcheries across the country have created a positive environment for the further adoption of the technology. Over a period of time, the seed productions sector has been decentralised and more and more states are encouraging local production of the seed. The locally produced seed has distinct advantage over the seed procured from distant markets. The seed available from the markets are mostly brought from the West Bengal and has been widely distributed. It requires a considerable time and cost to transport these seeds. Moreover, there is wide scale mortality and uncertainty of the seed quality and it is difficult to make the seed producer accountable for the quality. Whereas the locally produced seed from the FRP hatcheries is preferred by the farmers as the farmers are being able to see the brood stock and monitor the seed production process to their advantages.

At one time about 85% of the seed in the country was produced by West Bengal and the vast network of the hatchery operators and seed producers are being able to supply to the whole country through a well developed marketing network. Presently, the state is producing about 52% of the seed requirements of the country and the network of the seed market is operating as efficiently as before. But, the respective state governments of the country are encouraging localised seed production. The local seed production ensures qualities, reduces mortality and enhances adaptability to the pond environment. The local seed production generating a large quality of employment potential which contributes positively to the local development. The small investment requirement in the FRP hatcheries has an advantage as the system can be set with limited fund and in small areas. The portable hatcheries as a package can easily be integrated into any development programme with limited fund and expertise. These advantages make the plastic hatchery adaptable to the new environment. Now, every

state government, Non-government organisation, private enterprises and farmers are encouraging the use and adoption of the portable hatchery technology. The present social and policy context is suitable for the adoption of the portable hatchery.

10.8. Forward and backward linkages

The portable hatchery operates as a small part of the chain of whole process of the seed production. In the backward chain brood stock maintenance and production, and forward chain nursing and rearing is critical to produce the quality and quantity of seed. Therefore, the efficiency of the seed production involving hatchery is related with these two linkages. The same is applicable to every category of the hatchery operated for the spawn production. The production of the quality seed is dependent primarily on the quality of the brood stock. The specific recommended practices of selecting and feeding the brood stock is available and adopted by hatchery operators. Similarly, the production of fry from spawn and fingerlings from fry involved specialised training, package of practices and skill. The land space available for the seed production from the spawn is critical to the success of the hatchery operations. These three sets of activities in seed production i.e brood stock maintenance, spawn production and seed rearing are undertaken either by one operator or multiple operators. The diverse set of the systems are available in the country. The large seed producers generally maintain integrated farm to produce fingerlings from the brood stock. But many small operators are linked through specialised activities in brood stock raising, hatchery, seed nursing and rearing among individual operations. The second category of the system of seed production is widely prevalent, particularly among the small operators and FRP hatchery operators. In addition, there are multiple types of forward and backward integration or linkages. The contract farming of the seed rearing between the hatchery operators and seed growers are also prevalent. In such case, the inputs are provided by nursery operators including spawn and seed growers provide land, water and labour. The profit is equally shared by partners. In some cases, the seed growers provide brood stock to hatchery operators for spawning and the spawn produced are equally shared. The institutional framework in the linkages determines the efficiency of the seed production system. Therefore, the FRP hatchery operations can be seen in the context of these linkages that are essential elements and preconditions to the efficient use of the technology for seed production.

10.9. Sustainability of the Technology

The sustainability of the technology is dependent on the activation of the self-sustaining forces in dissemination and operation of the technology. In other words, the technology needs to be economically viable, socially acceptable and environmentally friendly to be considered as sustainable. The commercialisation of the technology by CIFA is a big step forward in the sustainable dissemination of the technology. Now, the

production of the gadget is handled by the private sector on payment basis with desired profit. Hence, the technology is available on payment and the element of sustainability is inherent in it. At the production level the benefit cost ratio is in the favour of producer as the producers are expected to return back the investment in three years period and the technology is expected to operate at the profitability of 30 to 40% of the investment. As compared to the conventional hatchery, the water requirement is lower and small sized pools require minimum quantity of water. But, the sustainability of the operations is dependent upon the institutional linkages with the forwards and backward functions as indicated above. The general impressions at present indicate towards sustainability of the technology at the operator level. The actual sustainability can be assessed after few years when the operations pass through many years of the test.

10.10. Issues and Constraints

Even though the hatchery is made available wide across the region, locations and institutions, the utilisation of the technology is not uniform. Few cases there are full utilisation and used in the commercial scale for spawn production. Where as many of them are still not being installed or underused well below the potential. As of now, the information on the utilisation of the technology is not available, but the indications on the issues and constraints affecting operation of the technology is available. Below is the few issues affecting the operationalization of the technology as the users level.

Underutilisation of technology: Even though most of the hatchery sets are being despatched to many locations across the country, all of them are not in operations either due to lack of installation or availability of the facilities and infrastructure required for the operation of the hatchery. The water shortage, lack of technical expertise and lack of operating manpower, etc are the reasons for lack of installation of the hatchery

Non-availability of brood stock: Brood stock availability is a major constraint in operation of the portable hatchery. The present system of the dissemination is not taking into consideration the brood stock development. The brood stock is not easily available from the market. In many cases, the hatchery operators are depending upon the culture ponds for brood stock. Culture ponds are not a reliable source of the brood stock as it is not produced for the purposes nor is the best source of quality brood stock.

Lack of rearing facilities: Most of the hatchery operators have small rearing facilities but for the full operation of the hatchery a large area of seed rearing is required. For each operation about 3 ha of rearing space is required for a full operation about 50-60 ha of the rearing space is required. Most of them are not well connected to the seed producers. Therefore, enough demand for the spawn is not created.

Lack of technical knowledge on rearing: Specific skill, attention and entrepreneurship are required for the seed raising. The training and experience are essentially required to raise seed as without it there would be mortality and loss. But, technological package disseminated to the hatchery operators does not include extending seed production technology. Therefore the lack of the technical knowledge on seed production is a major constraint in operation of hatchery.

Inadequate rearing network: It has been observed that the large portion of the beneficiary of the technology are the small scale operator, institutions like universities, KVK, NGO lacking adequate rearing space to grow seed. Even though the capacity to produce spawn from the hatchery is quite large, the space required to grow them is generally outside their control. Many small scale fish seed growers, women farmers, SHGs are involved in rearing. But, the network is often weak and unreliable as there is lack of coordination among them. Due to lack of such network, the hatcheries are not operating at its potential.

Competition from organised market: Many of the FRP hatchery operators are new entrant into the business and therefore lack adequate strategy and skill to operate in market. On the other hand, the organised markets, particularly the network of traders of West Bengal is highly developed in eastern India. They are able to deliver fry at door step. In order to compete to these agents, the hatchery operators along with the seed growing networks needs to equip with skill and strategy to compete with the market.

Lack of entrepreneurial skill: The operation of the hatchery require arrangement of inputs, development of rearing network, marketing skill as well as other management capabilities. But the beneficiaries of the FRP hatchery often lack this enterprising ability. This is particularly constraining when the institutions are involved in hatchery operations and the spawn production are under the potential.

Lack of production orientation: The colleges, NGOs and other institutions using the technology are not oriented towards the production of spawn and seed. The hatchery is being used for demonstration or instructional purposes like teaching and training. The gadget is only used once and twice and therefore not contributing to the seed production in the region.

10.11. Impact of the Portable Carp Hatchery in India: Methodological Challenges

The impact assessment of the FRP hatchery is challenged by many methodological difficulties in ascertaining and qualifying the benefit of the technology. As discussed earlier, the hatchery is fundamental in the seed production, but only an intermediate step in the whole process of the seed production. The success of the spawning is dependent upon the availability of the brood stock and rearing space as backward and forward linkages. The aquaculture is the whole chain of the brood stock production,

hatchling production, seed production of fry and fingerlings and grow out culture. Each of these steps is linearly related and each of steps involves distinct technology or package and practices. In the process of the development each of the steps interact and influence with each other. Therefore, it is difficult to assess the impact of the hatchery in isolations. The spawn produced from the hatchery is ultimately reflected in the fish production but in each stage it generates enough economic benefits to make them self-sustaining. Therefore, the impact of the hatchery can be assessed as direct economic benefits accrued to the hatchery operators as well the contributions it makes in the whole process of the aquaculture development. For the estimation of the second category, the comprehensive impact of the whole aquaculture needs to be assessed.

The second order methodological issue is related with the identifying the control upon which the comparison can be made. In most cases, these activities are taken as new initiatives and land requirements are either minimal or less. In few cases, the unused lands like low laying flooded areas are being used for the purposes. The aquaculture are being practiced in the existing water bodies. In few cases, the agricultural land has been converted into aquaculture ponds. Therefore, it is difficult to compare the hatchery

Table 10.5. Framework to assess impact of FRP hatchery

Stages of aquaculture	Technology involved	Output	Types of benefits	Beneficiary
Brood stock development	Brood stock management	Brood stock	Income Employment Fish consumption	Grow out farmer Hatchery operator Input suppliers
Hatchery	Breeding technology Hatchery technology	Spawn or hatchlings	Income Employment	Hatchery operator Input suppliers Technician
Seed growing	Nursery raising Seed rearing	Fry or fingerlings	Income Employment	Small farmers Hatchery operator
Growout culture	Culture technology	Table fish	Fish consumption Income Employment	Producer farmers households Input suppliers
Harvesting	Harvesting technology	Fish harvest	Consumption Income Employment	Fishers households
Marketing		Fish distribution and disposal	Income employment	Traders Ice supplier
Consumption		Consumption	Consumption	Consuming Households

and other activities with their earlier activities. The both 'before and after' as well as 'with and without' approach cannot be applied easily and uniformly. The only option available is to estimate the actual economic benefits as return over the cost. In addition, the livelihood, employment and consumption benefits can be estimated.

The table indicates there are a complete set of the activities related to the hatchery in forward and backyard linkages. In each stage of the fish production a large number of the beneficiaries are being involved. The producers, technician, input suppliers, trader, fishers and consumer households are all the beneficiaries of the fish production process. Even though the benefits from the other stages of the production are not directly benefited from hatchery, the indirect benefit is quite significant and it encourages and provided vital inputs to the production process. Therefore, the direct and indirect needs to be taken into consideration while assessing the impact of the portable hatchery.

10.12. Conclusion

The FRP hatchery technology is a new innovation that has been made available to the seed produces from the year 2006. Till the year 2011 about 126 numbers of the sets has been sent to different places and it has been at the various stages of the adoptions. The early indication shows that the technology per se is very successful in producing spawn, but the issue of the business development, sustainability, linkages, technical support, brood stock, etc are the major constraints affecting full operation of the technology. Moreover, the experiences and feed back in the adoption will help in developing strategy for the better management of the technology. An impact assessment study has been initiated which will give an indications of the impact of the technology on the society.

Reference

- Ahmed, M. and M. H. Lorica, 2002, Improving developing country food security through aquaculture development - lessons from Asia. *Food Policy*, **27**:125-141.
- Bhalla, G.S. and Gurmail Singh, 2009. Economic Liberalization and Indian Agriculture: A Statewise Analysis, Review of Agriculture, *EPW Economic & Political Weekly*, December 6, 2009 Vol xlv no 52.
- CIFA, 2004. Portable FRP carp hatchery. In: *CIFA Technologies*, Central Institute of Freshwater Aquaculture (ICAR), Bhubaneswar: 22-23
- CIFA, 2005. Parigamaniya (portable) FRP carp hatchery (in Hindi). In: *CIFA Pradyogiks*, Central Institute of Freshwater Aquaculture (ICAR), Bhubaneswar: 27-30.
- Dey, M.M., P. Kambewa, M. Prein, D. Jamu, F. Paraguas, D. Pemsil and R. Briones, 2006, Impact of the Development and Dissemination of Integrated Aquaculture-

- Agriculture (IAA) Technologies in Malawi. In: Waibel, H. and D. Zilberman (Eds.). *The impact of NRM research at the CG Centers*. CAB International
- FAO, 2004. The State of World Fisheries and Aquaculture 2004. FAO Fisheries Department, *Food and Agriculture Organization of the United Nations*, Rome, 153 pp.
- FAO, 2010. The State of World Fisheries and Aquaculture 2010. FAO Fisheries Department, *Food and Agriculture Organization of the United Nations*, Rome
- ICAR, 2005. Portable plastic carp hatchery. In: *Aquaculture Technologies for Farmers*. Indian Council of Agricultural Research, New Delhi: 55-58
- ICAR, 2006. Portable plastic hatchery for carps. In: *Fish Farming and Technologies for the North Eastern Region: Pond to Plate*. Indian Council of Agricultural Research, New Delhi: 39-42
- ICAR, 2006. *Handbook of Fisheries and Aquaculture*. Publication Division. Indian Council of Agricultural Research, New Delhi
- IIM, 1985. Inland fish marketing in India-Inland seed production and marketing. Vol. 2. Indian Institute of Management, Ahmadabad. Concept Publishing House.
- Mahapatra. B.C., 2006. Application of plastics in aquaculture with special reference to portable hatcheries In: *Aqua-Tech 2006 and National Conference on Innovative Techniques and Remedies in Fishery Science*, Dr. Ambedkar College, Deekshabhoomi, Nagpur, 16-17 January 2006.
- Mahapatra, B.C., 2008. Portable FRP carp hatchery technology: Successful adoption in India. *Fishing Chimes*, **28** (4): 48-52
- Mohapatra, B.C. Bikash Sarkar, K. K. Sharma and N. Sarangi, 2008. *User's manual on portable FRP carp hatchery*. Central Institute of Freshwater Aquaculture, (Indian Council of Agricultural Research), Kausalyaganga, Bhubaneswar- 751002, Orissa, India
- Pillay, T.V.R. and M. N. Kutty, 2005. *Aquaculture Principles and Practices*. Wiley-Blackwell publication
- World Bank, 1991. Project completion report- India. Inland Fisheries Project. March 12, 1991. *Report No. 94 15*, World Bank, Washington DC