



A Web-based System on Herbicide Recommendation for Field Crops in India

Chayna Jana¹, Shashi Dahiya², V.K. Mahajan², T.K. Das³ and N.M. Alam¹

¹*ICAR – Indian Institute of Soil and Water Conservation, Dehradun*

²*ICAR – Indian Agricultural Statistics Research Institute, New Delhi*

³*ICAR-Indian Agricultural Research Institute, New Delhi*

Received 25 May 2016; Revised 11 July 2016; Accepted 14 July 2016

SUMMARY

Weed control is a prerequisite for obtaining higher yield in agriculture. Amongst several weed control measures, chemical methods using herbicides have been proved to be the most effective and economical though time consuming. The potential effects of herbicides strongly depends on right selection relating to their toxic mode of action and method of application. Therefore appropriate herbicide should be recommended at correct dose and time of application to increase weed control efficiency. To provide a support, a web based application was designed and developed which will work as an online reference providing necessary information about various field crops, weeds, herbicide details, and appropriate herbicide recommendations across weeds and crops. It also provides scientific expertise to researchers, students, extension personnel and the end users nation wide towards the weed management in field crops using herbicides.

Keywords: Web based system, Weed, Herbicide, Phytotoxicity.

1. INTRODUCTION

The country has made impressive progress in the field of agriculture. However it is one enterprise that faces uncertainty at every stage due to its dependency on weather, weed, insect and pest infestation, problems in soil, seed breeding related problems, crop and seed related diseases and fertilizer related problems (Chadha 2001). If any one of these problems can be addressed at grass root level using manual/mechanical methods or through extension programmes making use of modern Information and Communication Technologies, a direct impact on the food production can be seen. With this principle, several studies have been conducted to develop ICT based applications which facilitate farmers or end users to identify various problems in agriculture farming and adopt suitable strategies

to deal with it (Das 2000, Kumari 2005). In this paper an emphasis has been made on protecting the crop from different kinds of weeds by making an information system on herbicide use for field crops in India.

Weed has emerged as a major problem day by day. Every crop is exposed to severe competition from weeds. On agricultural lands, weeds are the unwanted plants that grow without human efforts. They have the characteristics that permit them to rapidly invade new areas and compete natural plants for light, water, nutrients and space and thus reduce the crop yields (Kumar and Jagannathan 2003). In some crops, the yields are reduced by more than 50% due to weed infestation (Johnson *et al.* 2004, Wall and Smith 2000, Milberg and Hallgren 2004). Weed control through manual/mechanical methods are effective, though they

have certain limitations such as unavailability of labour during peak period, high labour cost, involves drudgery, unfavorable environment particularly in rainy season etc. (Saraswat *et al.* 2003). Use of herbicide is an important method in the modern weed management technology. Farmers are also using herbicides and different control measures for controlling weeds. But it is limited to few crops and few regions because of the lack of awareness, information on the availability and application of these herbicides.

The information on herbicide use for weed control is widely distributed and scattered in different printed forms i.e. books, magazines, journals etc. Going through all these books and magazines to obtain desired information is not an easy task and all that at same time it is very time consuming and cumbersome. Hence, considering all these requirements, there has been an urgent need to design and develop a comprehensive web-based information system on herbicide use for weed control. The users of this system are expected to be primarily extension personnel, researchers, students, policy makers, farmers etc.

This web-based software will help the farmers and extension personnel in getting information about appropriate herbicide recommendation in field crops and their practices within a few minutes through any internet enabled system. Policy makers can plan efficiently and researchers can enhance to support their learning process.

There are number of national and international institutes, which are actively conducting work in the area of weed, herbicide and herbicide application with the objective of exchanging information and experiences on herbicide recommendation and its applications and dissemination of this information to other potential users (Rydahl 2004, Thomas and Willoughby 2004, Yadav 2003, Martin *et al.* 2001). In India, though the extension workers of State/Central Agricultural Departments and Universities, Krishi Vigyan Kendras (KVK), Krishi Gyan Kendras (KGK) disseminates the useful information of herbicide applications on individual basis, but there is no web enabled information system available which can provide the digitized expert information at any time any place. Such information system can be utilized by

the extension personnel for their dissemination purposes. They can educate the farmers or end users about the method of retrieving required information from the information system. So there is a strong need to develop a web enabled information system on herbicide use in India.

2. MATERIALS AND METHODS

The software on herbicide use is a web-based application based on three-tier client-server architecture and can be accessed from any computer connected to the internet. A relational database has been designed to hold the information of crop, weed, herbicide details, herbicide recommendations, and its applications etc. in a tabular manner that would facilitate selective retrieval at the time of report generation.

It functions at three layers –(1) Application/Presentation layer, (2) Business layer and (3) Database layer.

Application/ Presentation layer is the form which provides the graphical user interface (GUI) to the end user. This layer is used for designing user interface and to get or set the data back and forth using Hyper Text Markup Language (HTML) and JavaScript. The layer has been designed using cascading style sheet (CSS) to maintain the design uniformity in all the web forms. Various user-friendly menus, submenus are created to make the information retrieval, data entry/ updating and search very easy. In this layer the validation controls of Microsoft .NET framework have also been used at all appropriate places to ensure complete and errorless data entry in all data management forms at client side.

The Business layer consists of a set of programming code on the web server which can mediate the communication between the database layer and the application layer. The server side coding in the information system has been done with Visual Basic (VB) programming language in Visual Studio (VS) using .NET Integrated Development Environment (IDE). It facilitates the data retrieval, data entry/ updating by communicating with database layer. This layer encapsulates the entire interaction with the database and hides the details from the presentation layer.

The purpose of the Database layer (DBL) is to store the data in an organized and structured way and to enable the retrieval of specified data by multiple, simultaneous users. Microsoft SQL Server 2008 has been used for its implementation. The structure used for storing the data is the relational, normalized structure.

3. DATABASE DETAILS

All the information related to crops, weeds, herbicides and their recommendations were collected from Division of Agronomy, ICAR-Indian Agricultural Research Institute (IARI), New Delhi and secondary sources (Yaduraju 2004). An Entity Relationship diagram (Fig. 1) was prepared to link all the entity tables based on their relationships.

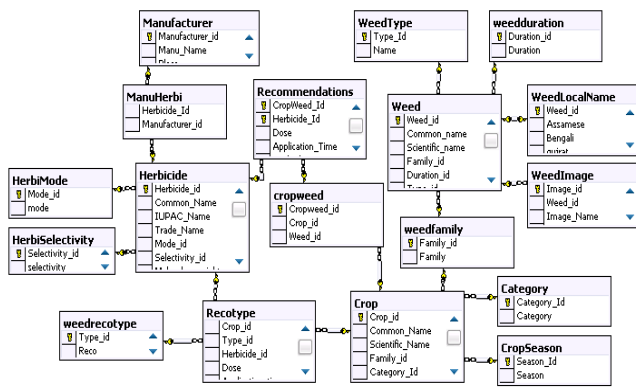

Fig. 1: ER diagram of the database

4. RESULTS AND DISCUSSION

4.1 Software Functionality

The developed software is divided into two dynamic modules:

- Data Management module
- Reports module

Based on the modules, there are two kinds of users for using this software. First being the Administrator who is an authorized person responsible for addition, updating of data in the system. Secondly there is an end user, who can only generate and view the reports as per requirement. Home page of the software (Fig. 2) provides all the links for accessing the desired information

of crops, weeds and herbicide recommendation. For accessing data management module, user has to provide proper login information for authentication (Fig. 3). Otherwise for generating and viewing the reports, users need not go through any authorization procedures. Software has its own authorization rules for login to administrator page. The detailed software operation with data flow is graphically illustrated in Fig. 4. The developed web-based application is freely available to all. Anyone can access the application online with free of cost. The application will be made available at www.cswcrtiweb.org website.

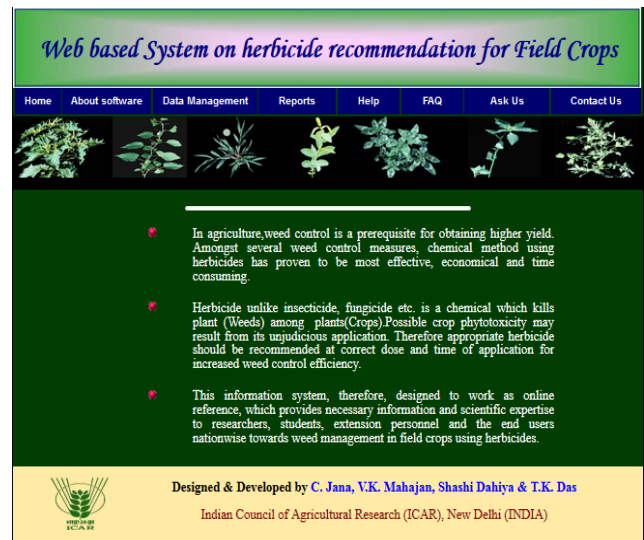

Fig. 2: Home page of web based software



Fig. 3: Login page for authenticated user

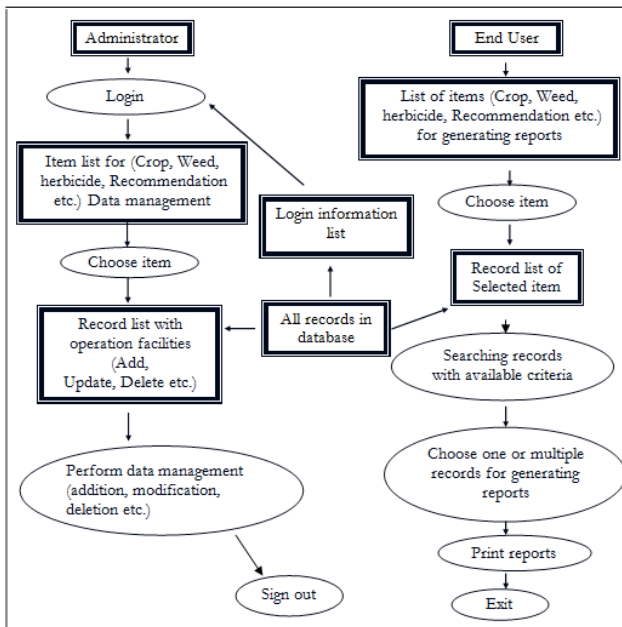

Fig. 4: Software operation diagram

5. DATA MANAGEMENT MODULE

Data Management module (Fig. 5) provides all the options viz. crop, weed, herbicide, herbicide recommendation, local names etc. for addition, modification and deletion purpose. Administrator can login into the data management module and perform the desired operations. He can add, modify, delete crops, weeds, herbicides information and upload images, herbicide recommendation etc. based on the requirement.



Fig. 5. Data management page

The options ‘Insert New’, ‘Save’, ‘Edit’, ‘Cancel’, ‘Delete’ are provided to perform all the data management operations of Inserting, Saving, Editing, Canceling and Deleting the records. Uploading images of crops and weeds can be done

by browsing through the system and selecting the required image. This will upload the image and save it in the database.

For updating of fields, the desired record can be selected from the list of records. Then the form with the selected record filled in is shown on the same page and the desired changes can be done. Here, sorting criteria are also given to sort the records in a particular order. Records can be searched very easily from the list of records by selecting any sorting criteria from the Sort by option.

For instance, crop management module provides the list of all records related to field crops with addition, modification and deletion facilities (Fig. 6).



Fig. 6: Crop data management module

Administrator can select any record from the list to view the details. All operation options viz. add/change images, add new crop, modify existing crop details or delete any crop are available for data management for that selected record. Sorting criteria based on common name, scientific name, family, category and season are also provided for quick searching of the desired crop.

The following Data entry/Updating tasks can be accomplished through this module.

- Add new crop, weed, herbicide, herbicide recommendation information.

- Update crop, weed, herbicide, herbicide recommendation information.
- Linking existing weed record to a crop.
- Uploading images of crops and weeds.
- Adding new crop family, category and season.
- Adding banned herbicides, commercially available herbicides in India etc.
- Adding/Updating state wise local names of weeds in India.
- Adding/Updating frequently asked questions with answers.

The Administrator or authorized user is authorized to perform all the above tasks. User should sign out the system after necessary operation to close the session.

6. REPORTS MODULE

This is the output module of the information system designed and developed according to the needs of the user group of the system. This is the most user-friendly part of the system. The information can be generated in the form of reports on the following aspects:

- Various crop details
- Crop wise weed information
- Crop and weed wise herbicide information
- Herbicide recommendations for weeds
- State wise local names of weeds in India

List of herbicides commercially available in India, herbicide under development, banned herbicide in India.

The user can generate any report of his interest just by choosing the Reports option and selecting some parameters from a variety of list boxes provided. In report page, all the aspects on which reports can be generated are listed in the left frame. User can select any item from the left frame; example if Weed is selected then the weed list can be viewed based on Common Name, Scientific Name or Local Name. Some more enhanced search options such as “Search by Weed

Category” or “Search by Weed Family” are also available in the right frame (Fig. 7).

Fig. 7. Weed selection form

Then user can select one or multiple Weed names for viewing their detailed information (Fig. 8). The Print button is also provided, clicking on which the information displayed can be printed. Similarly, user can view crop report, weed local name, weed miscellaneous information.

Fig. 8: Weed report

Herbicide Recommendation Report: The Herbicide recommendation module is the most important part of this software. It gives the detailed herbicide recommendations for weeds/specific weed present in a particular crop field. User has to go through three steps for generating this report. First, crop selection has to be done from the Crop Selection Form (Fig. 9). After selecting the crop, related weeds of the selected crop will be listed in the weed selection form (Fig. 10). From this form user can select a specific weed or weed type (Grass, Composite weed, Sedge, Broad Leaf) for getting their recommended herbicide List (Fig. 11). From this list single/multiple herbicides

can be selected for getting their detailed herbicide recommendation report (Fig. 12).



Fig. 9: Crop selection form for herbicide recommendation

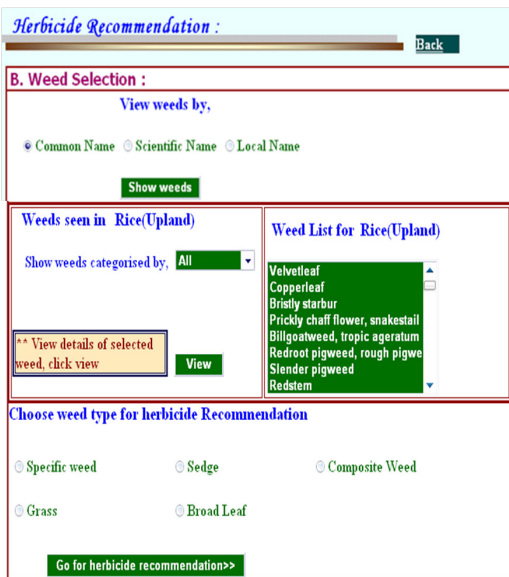

Fig. 10. Weed selection form for herbicide recommendation

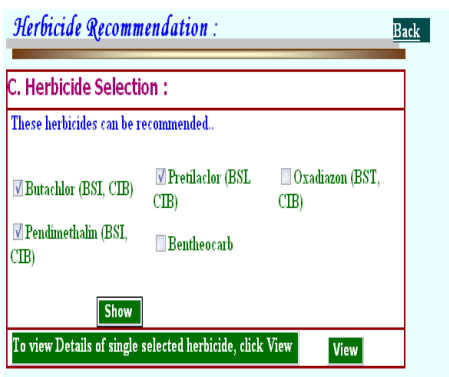

Fig. 11. Herbicide selection form for herbicide recommendation

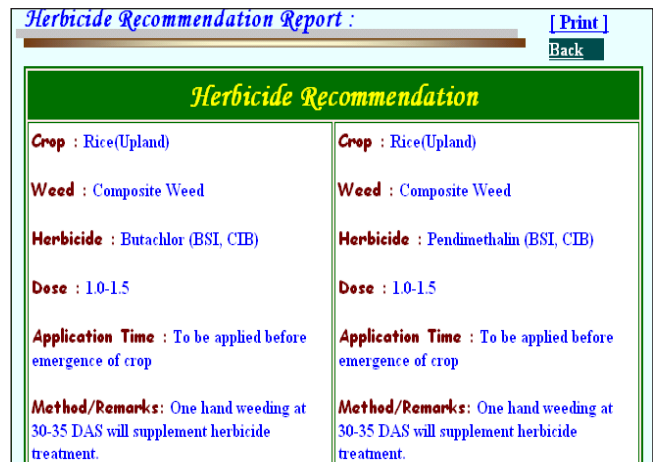

Fig. 12: Detailed herbicide recommendation

7. INFORMATION BASED ON KEYWORD

User can enter any consecutive keyword (only alphabet) for searching information about crop, weed and herbicide directly without going into the report module.

8. HELP

Software help page is available by clicking on help option (Fig. 13). In help page, links for ‘User’ and ‘Data Management’ help are provided for user status and data management operations. Besides these, it contains the general information about crop, weed, and herbicide. User can view this information by clicking the corresponding link.

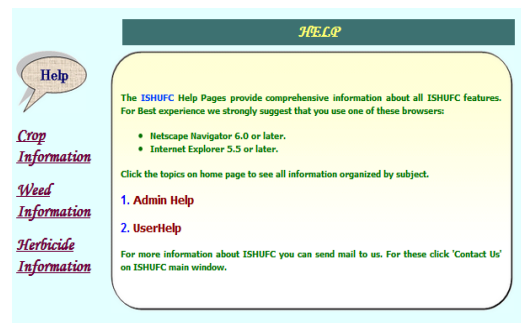

Fig. 13: Help page

9. ASK US

If users want to send any questions /comments to Administrator then they can send it through “Ask Us” page (Fig. 14). Users have to specify their e-mail address, question and mode of reply.

Fig. 14: Ask us page

10. FREQUENTLY ASKED QUESTIONS

Users can view some of their queries by viewing the Frequently Asked Questions (FAQ) where all the queries are displayed (Fig. 15). To view the answer, click on any queries (Fig. 16).

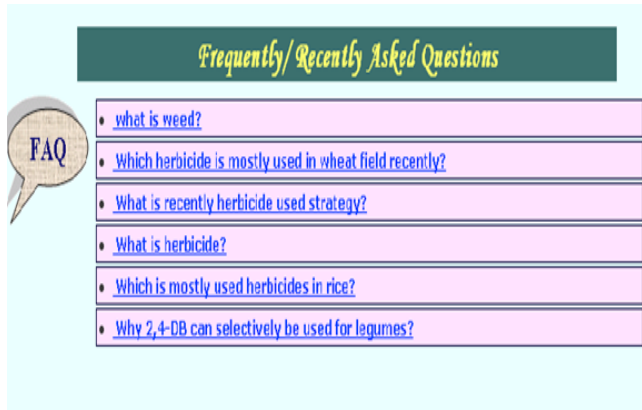

Fig. 15. FAQ

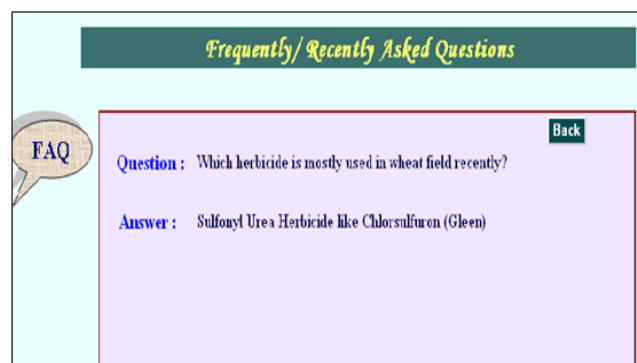

Fig. 16. FAQ question with answer

11. CONCLUSION

A web based system accomplishes the tasks of static information retrieval, online data management, dynamic reports generation and online help. The basic reason behind the development of this web-based system is to provide the extension personnel, farmers, students and researchers the relevant information about the herbicide recommendations for weeds present in a particular field crops which help them in decision - making while selecting the right herbicides, their right doses, time of their applications, procedures for different weed control in crop fields. It also provides comprehensive information about crops, weeds, herbicides, list of herbicide manufacturers, weed local names etc. A keyword based search facility has been provided by the system for searching information about Crops, Weeds, and Herbicides etc. On-line help scheme has been provided to help users acquaint themselves with the system and to learn the operation of the system. There is a facility for image uploading for crops and weeds in the database. The feature of providing information to users through frequently asked questions has also been included in this software. No software can claim to provide complete solution for all problems of given type and for all time to come. The present software is the first version and there is a scope for further enhancement. The software may be further improved by including herbicide recommendations based on weed density, herbicide dose calculations and tank mixtures with mixing components etc.

REFERENCES

- Chadha, K.L. (2001). *Handbook of Agriculture*. ICAR Publications, New Delhi. 1-21.
- Das, S. (2000). Web based Information System on Integrated Pest Management of Cucurbits. Unpublished M.Sc. Thesis, I.A.R.I., New Delhi.
- Johnson, D.E., Wopereis, M.C.S., Mbodi, D., Diallo, S., Powers, S. and Haeefe, S.M. (2004). Timing of weed management and yield losses due to weeds in irrigated rice in the Sahel. *Field Crops Res.*, **85**, 31-42.
- Kumar, R.J. and Jagannathan, R. (2003). *Weed Science Principles*. Kalyani Publishers, New Delhi.
- Kumari, A. (2005). Information System for Major Fruit crops (Apple, Banana & Mango) of India. Unpublished M.Sc. Thesis, I.A.R.I., New Delhi.

- Martin, S.G., Acker, R.C. Van and Friesen, L.F. (2001). Critical period of weed control in spring canola. *Weed Sci.*, **49**, 326-333.
- Milberg, P. and Hallgren, E. (2004). Yield loss due to weeds in cereals and its large-scale variability in Sweden. *Field Crops Res.*, **86**, 199-209.
- Rydahl, P. (2004). A web-based decision support system for integrated management of weeds in cereals and sugarbeet. *Bull. OEPP EPPO Bull.* DOI: 10.1111/j.1365-2338.2003.00679.x.
- Saraswat, V.N., Bhan, V.M. and Yaduraju, N.T. (2003). *Weed Management*. I.C.A.R., New Delhi.
- Thomson, Alan J. and Willoughby, Ian. (2004). A web-based expert system for advising on herbicide use in Great Britain. *Comp. Elect. Agric.*, **42**, 43-49.
- Wall, David A. and Smith, Marjorie A.H. (2000). Quackgrass (*Elytrigia repens*) management in flax (*Linum usitatissimum*). *Canad. J. Plant Sci.*, **80(2)**, 411-447.
- Yadav, V.K. (2003). Information System on Pesticide and their Documentation. Unpublished M.Sc. Thesis, I.A.R.I., New Delhi.
- Yaduraju, N. and Dixit, A. (2004). *Herbicide Manual*. National Research Centre for Weed Science, Maharajpur, Jabalpur.