

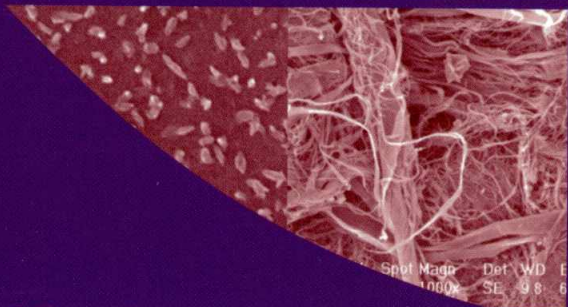

CIRCOT



Annual Report 2008-09



Central Institute for Research on Cotton Technology
(Indian Council of Agricultural Research)
Adenwala Road, Matunga, Mumbai-400019

CIRCOT

ANNUAL REPORT

2008-2009



Central Institute for Research on Cotton Technology

(Indian Council of Agricultural Research)

Adenwala Road, Matunga, Mumbai 400 019

Address : CENTRAL INSTITUTE FOR RESEARCH ON COTTON TECHNOLOGY
(Indian Council of Agricultural Research)
Adenwala Road, Matunga, Mumbai 400 019

Telephone : 2412 7273/76, 2415 7238, 2418 4274/75 Fax : 022-2413 0835 / 2415 7239

E-mail : circot@vsnl.com Website : <http://circot.res.in>

Gram : TECHSEARCH Nearest Railway Station : DADAR

**Cover Theme : Ongoing
NAIP Projects at CIRCOT**

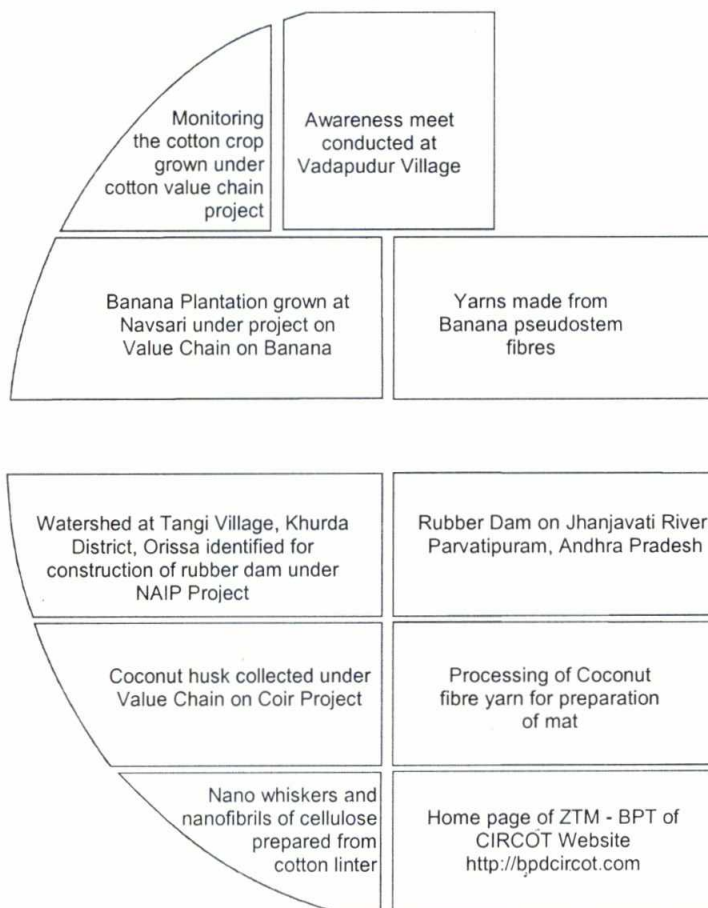

Edited & Published :

Dr. S. Sreenivasan, M.Sc., Ph.D., F.T.A., C.Text, F.T.I.
Director, CIRCOT, Mumbai

Compiled by :

Shri M. Mohan, Dr. C. D. Ravindran,
Shri Chitranayak and
Shri V. B. Suryanarayanan

Cover Design and Layout : **Shri V. B. Suryanarayanan** and **Dr. A. J. Shaikh**

Printer :

Unity Printers, Wadala, Mumbai 400 031

CONTENTS

Preface

Executive Summary i

सार संक्षेप i

1. INTRODUCTION 1

2. RESEARCH ACTIVITIES 11

3. TECHNOLOGY ASSESSED AND TRANSFERRED 47

4. EDUCATION AND TRAINING 49

5. LINKAGES AND COLLABORATION 51

6. PUBLICATIONS 56

7. LIST OF ON-GOING PROJECTS DURING 2007-2008 60

8. SRC, RAC AND MANAGEMENT COMMITTEE 64

9. PARTICIPATION OF SCIENTISTS IN CONFERENCES 69

10. WORKSHOPS, SEMINARS, SUMMER INSTITUTES 72

11. DISTINGUISHED VISITORS 84

12. INFRASTRUCTURAL FACILITIES 87

13. PERSONNEL 89

Preface

It is my proud privilege to present the eighty-fifth Annual Report of CIRCOT pertaining to the year 2008-09 to the distinguished readers. Yet another milestone has been crossed by this unique institution serving the cause of Indian cotton both at the national and international level.

Maintaining its second position in production after China, the Indian cotton output for 2008-09 is expected to be about 290 lakh bales from a cultivated area of about 94.06 lakh hectares, thereby realising a productivity of 525 kg/ha. The Bt cotton area during the current season has further climbed to reach about 80%. Since majority of the Bt cotton hybrids developed by the private sector and released by the Governmental channels belong to the long category, the wide staple indigenous base from the "shortest to the longest" once enjoyed by the Indian industry is no more there. In addition to erosion in "biodiversity" in the production system, the user industry now faces shortage in the short and medium category of cotton adding to the already existing shortfall in the extra-long staple.

Amidst the gloomy picture of erosion of staple base for Indian cotton, came the pleasant news of release of "Bikaneri Narma Bt" cotton variety by the Central Institute for Cotton Research, Nagpur. CIRCOT as a technology partner in this endeavor is proud of this historic achievement of the cotton production system under the ICAR. It is hoped that this Bt cotton variety would receive the

much expected patronage by the governmental seed producing agencies and also from the Indian farmers who now do not need to buy costly Bt seeds year after year.

A historic moment in the CIRCOT's proud legacy came about this year on November 1, 2008 when the foundation stone laying ceremony was performed for the "Yeshwantrao Chavan Building" at CIRCOT at the hands of the Honourable Union Agriculture Minister, Shri Sharad Pawar. All the members of staff of CIRCOT would like to gratefully acknowledge the contribution made by the Honourable AM, the Secretary, DARE and DG, ICAR in making this a reality. Hectic efforts are on at the Institute level with CPWD, Mumbai region to see that the construction work starts at the earliest.

The foundation stone laying ceremony was also performed for the construction of Type IV quarters at Mahim during the current year at the hands of Dr. Nawab Ali, the then Deputy Director General, Indian Council of Agricultural Research on November 25, 2008. Although the delay in obtaining municipal permission for this construction has been the reason behind this activity going beyond schedule, every effort is being made with all the seriousness at CIRCOT with CPWD to get this work started at the earliest. The newly renovated Committee room was also inaugurated by Dr. Nawab Ali. This Committee room was named after Dr. V. Sundaram, former Director, CIRCOT as a mark of respect and in recognition of Dr. Sundaram's epic

contribution to Indian cotton and to the growth of this institution.

The CFC, Netherlands funded project on "Utilisation of Cotton Byproduce for Value Added Products" currently in operation at CIRCOT has been progressing well and the supply chain mechanism for cleaned and chipped cotton stalks to the board industry through the involvement of rural agent has been further strengthened and demonstrated during the year. As a component of the technical programme for the extended period of the project, a market demand study has been organized with the involvement of a market research agency. In an effort to disseminate the project results, an international workshop has been proposed to be organized during November 2009 in which participation of researchers/entrepreneurs/ government officials from twenty-five cotton growing countries is being ensured.

CIRCOT has been identified to execute six sub projects under the World Bank funded National Agricultural Innovation Project (NAIP) of ICAR based on the project proposals submitted by the Institute, three as consortium leader and remaining three as partner. The project on Value Chain on Banana Pseudo Stem Fibre (Partner, component 2), Nano Cellulose Preparation and its Use in Biodegradable Polymers (Leader, component 4), Value Chain on Coconut Fibre (Partner, component 2) and Business Planning and Development Unit at CIRCOT (Leader, component 1) have been launched during the year and are progressing well as per the technical programme set for the year. The Zonal Technology Management Unit and the

Business Planning and Development activities have been able to attract the attention of the industry and entrepreneurs and it is hoped that in the near future a few of the technologies from CIRCOT would translate into business endeavour. This cell is also working out programmes to bring in awareness among the ICAR institutes in the region and preparing a catalogue of potential/ bankable technologies available in ICAR Institutes in the Western Zone.

The year 2009 has been proclaimed as the Year of Natural Fibres by the United Nations. As part of the annual programme and celebration of Natural Fibre Year, under the aegis of ICAR, the CIRCOT-based Indian Society for Cotton Improvement and Indian Fibre Society together are planning to organize an International Seminar on Production, Processing and Value Addition to Natural Fibres in Mumbai during April 2009. Also the Council is looking at the possibilities of organizing the natural fibre research under ICAR into a more cohesive network mode, facilitating inter institutional consultations and interactions. Hopefully the Scientists involved in the natural fibre group, dispersed among various ICAR institutes, would seize this opportunity and organize themselves and carry out research in coordination in a consultative approach to enable ICAR to project its research achievements more effectively to people at large during the International Year of Natural Fibres and beyond.

*S. Sreenivasan
Director*

Foundation Stone Laying Ceremony for the Yashwantrao Chavan Building of CIRCOT

The foundation stone laying ceremony for the Yashwantrao Chavan Building of CIRCOT was held on November 1, 2008. Shri Sharad Pawar, Union Minister of Agriculture, Consumer Affairs, Food and Public Distribution, Government of India performed this auspicious function in the presence of Dr. Mangala Rai, Secretary (DARE) and Director General, ICAR, Dr. Nawab Ali, Deputy Director General (Engg.), ICAR, Dr. S. Ayyappan, Deputy Director General (Fisheries), ICAR, Dr. Pitam Chandra, Assistant Director General (PE), ICAR and Dr. S. Sreenivasan, Director, CIRCOT. The ceremony was attended by a large number of representatives from the cotton trade & industry, Textile Ministry, Academic Institutions and media. The Honourable Minister was then taken round an exhibition depicting the research activities currently being carried out at CIRCOT.

A meeting was organised at the Jubilee Hall of CIRCOT following the function. Dr. Nawab Ali, DDG (Engg.) welcomed the Honourable Minister and all the invitees. Two publications viz. **Cotton Ginning-Technology, Troubleshooting and Maintenance** and **Handbook of Methods of Tests for Cotton Fibres, Yarns and Fabrics - Part 3** were released at the hands of the Honourable Minister. Dr. Mangala Rai, Secretary (DARE) and DG, ICAR while highlighting the cotton scenario and the Institute's contribution to the development of high quality cotton in the country, hoped that additional space to be made available at the Institute would go a long way in carrying out diversified activities in future.

Shri Sharad Pawar in his presidential address eulogistically referred to the contribution made by late Yashwantrao Chavan to the country's growth and development. While congratulating the Institute for achievements in quality cotton development and value addition to the biomass, the minister emphasised on the need to continuously develop technologies that benefit the farming community and the user industry.

Dr. S. Sreenivasan, Director presented the vote of thanks and the meeting ended with the singing of National Anthem.



Foundation Stone Laying Ceremony of Type IV Quarters

The foundation stone laying ceremony of Type IV Staff Quarters was held at the CIRCOT Staff Quarters Premises at Manmala Tank Road, Mahim on November 25, 2008. Dr. Nawab Ali, DDG (Engg.), ICAR laid the foundation stone in the presence of Dr. S. Sreenivasan, Director, CIRCOT, Dr. K.R. Krishna Iyer, Former Director, CIRCOT and staff members of CIRCOT and their family members. Dr. Nawab Ali congratulated the Director of CIRCOT for this new venture and hoped that the quarters will help needy staff members. Dr. Krishna Iyer expressed his happiness on the fulfillment of this long standing need of the staff members.



Inauguration of Dr. V. Sundaram Committee Room

As a mark of respect to Dr. V. Sundaram (Late), former Director of CIRCOT under whose stewardship (1966-88) the Institute grew into an Internationally acclaimed organization, the refurbished conference hall of the Institute was named as **Dr. V. Sundaram Committee Room**. A small function was held at the Institute in which Dr. Nawab Ali, Deputy Director General (ICAR) inaugurated the hall on November 25, 2009.



Salient Achievements at a Glance

Salient Research Achievements

- Cotton Bale Manager, a software for labeling cotton bales has been successfully tested. Using this software, it is possible to tag the bales with a unique ID indicating all the growth and quality related parameters.
- A cotton precleaner based on the principle of axial flow is designed and fabricated. The experimental setup is noted to be working satisfactorily.
- During the year 2008-09, 6687 cotton samples received under AICCIP has been tested and reported.
- Ninety-two trade and 54 standard cotton varieties received during the present year has been evaluated.
- A demand model to predict consumption of cotton fibre in the textile sector has been postulated.
- An instrument for measuring the electrical properties of textile materials has been fabricated with an accuracy of + 2% measurement. Several fabrics comprising different fibres have been tested using this instrument.
- A study on the structure-property relationships in friction spun yarns using the DREF system indicates that the properties of fibres like breaking strength, work of rupture and tenacity increase with the core ratio of the yarn.
- Standardization work on the Raspador installed at the Navsari Agricultural University for extracting fibres from banana pseudostem is completed. Extraction of the fibres has been satisfactory.
- A suitable latex component for increasing the strength of adhesion between the fabric and rubber has been identified. Also, a suitable fabric type for use in rubber dam has been identified.
- It was noted that the xylanase concentration could be improved four-fold by ultra filtration and acetone precipitation and that the specific activity could be increased by 3.3 fold.
- A 99% reduction in bacterial count could be achieved through chitosan treatment in cotton fabric.
- Nano-titania particles prepared by four different precursors have been characterised.
- There is a general reduction in oil content in the F2 generation of Bt. cotton hybrids although some contrary observations were noted. The nature of proteins present in Bt. cotton could be responsible for the contradictory behavior. Experiments are underway to confirm these results.
- A small scale trial of 1% propionic acid treatment for 100 kg cottonseed for preventing fungi growth was carried out.

Training, Consultancy and Technology Transfer Activities

- ✓ About 6084 cotton samples at the headquarters and 3862 at regional units under the paid test category were tested and around Rs. 21.6 lakh generated.
 - ✓ At the headquarters seventy-four sponsored personnel from cotton trade and industry underwent training in quality evaluation of fibres and use of HVI and AFIS and statistical interpretation of data. At the Ginning Training Centre, Nagpur, 119 gin fitters sponsored from various ginning industry underwent training in the operation of various machines and their maintenance. Revenue generation through training activity was around Rs. 9.8 lakhs.
 - ✓ During 2008-09, 796 CIRCOT calibration cotton containers were sold generating around Rs. 4.5 lakh. Significantly, 27 new HVI users purchased CIRCOT calibration cotton.
-

CIRCOT ANNUAL REPORT 2008-2009

- ✓ Nine consultancies were undertaken generating around Rs. 6 lakhs.
- ✓ Twelve new innovations were patented during the current year alone.

Awareness Programmes, Participation in Exhibitions and Organising Seminars/Workshops

- Awareness Workshop was conducted on Cotton Value Chain at Kothampaddi village near Attur in Salem District, Tamil Nadu on July 3, 2008 to increase the awareness for clean picking of cotton.
- The Fourth Review Meeting of the CFC funded project on Utilisation of Cotton Stalks for Value Added Products was held on August 30, 2008.
- Hindi Day/Fortnight Celebrations was organised during September 15-23, 2008.
- Farmers Awareness Meet was organised at Vadapudur village in Pollachi, Tamil Nadu, on September 26, 2008.
- Farmers Awareness Meet was held at Babhulgaon in Yeotmal District, Maharashtra on October 7, 2008.
- The Vigilance Awareness Week was celebrated at the headquarters from November 3-7, 2008.
- A Clean Cotton Picking workshop at Babhulgaon, Yeotmal District, Maharashtra was organised on November 18, 2008.
- Quami Ekta Week was celebrated at the Institute from November 19-25, 2008.
- Awareness Workshop on Clean Cotton picking at Vadapudur village in Pollachi, Tamil Nadu was conducted on December 2, 2008.
- Launch Workshop of the NAIP Project on Synthesis and Characterisation of Nano-Cellulose and its Application in Biodegradable Polymer Composites to Enhance their Performance was held on December 3, 2008.
- NAIP Launch Workshop on the Zonal Technology Management and BPD unit was inaugurated on January 24, 2009. Dr. Mruthunjaya, National Director, NAIP was the Chief Guest at the function.
- National Science Day was celebrated with a lecture by Shri B.B. Daundkar, Dy. Director, Forensic Laboratory, Mumbai on Recent Developments in Forensic Science.
- On the occasion of the International Women's Day on March 9, 2009, Kum. Najma, Advocate, Indian Centre for Human Rights and Law, Mumbai gave a talk on Women's Rights in Government Establishments.
- A six days training was imparted to the Supporting Staff from March 16-21, 2009 on matters pertaining to general administrative and accounts work.

The Institute participated in the following exhibitions

- ✓ Participated in the exhibition in **Pusa Krishi Vigyan Mela** organised by ICAR at IARI, New Delhi from February 23 – 26, 2009.

Accolades

- Shri Ashok Kumar Bharimalla, Scientist was deputed for training in **Cotton Processing for Superior Quality Yarn** to Egypt from April 12 to May 02, 2008.
- In the ICAR Inter-Institutional Western Zonal Sports Meet was held at CIFE, Mumbai from February 2-4, 2009, the Institute participated in different events and bagged various prizes in Table Tennis, Carom, Badminton, Discuss Throw, 100 x4 m Relay, and 100 m Race and a Special prize in Cycle race.
- The Institute has bagged the III prize in the form of a Shield for carrying out best work in Hindi by ASHIRWAD, a Literary-Socio-Cultural Organisation, Mumbai.

Budget Utilisation and Revenue Generation

- The Council sanctioned a grant of Rs. 4.70 crores for the Institute and it was utilized under the plan scheme.
- The revenue generation during the year stood at Rs. 56.14 lakhs.

Executive Summary

This is the Eighty-fifth Annual Report of CIRCOT and covers the activities of CIRCOT for the period from April 1, 2008 to March 31, 2009.

Introduction : CIRCOT was established as a Technological Laboratory under the Indian Central Cotton Committee (ICCC) in 1924. Indian Council of Agricultural Research (ICAR) took over the administrative control of the laboratory in 1966 when the ICCC was abolished along with other commodity committees. The laboratory was renamed as Cotton Technological Research Laboratory. To intensify research and reorient the activities in consonance with the research priorities of ICAR, new mandates were formulated. The laboratory was renamed as Central Institute for Research on Cotton technology on April 1, 1991.

CIRCOT continued to function as the coordinating centre for technology under the All India Coordinated Cotton Improvement Project and over 6,500 samples were evaluated for their fibre properties and spinning potential. More than 3,000 cotton samples from various breeding trials were assessed at the headquarters for fibre quality, while at the Regional Quality Evaluation Units more than 20,000 samples belonging to initial stages of breeding trials were evaluated.

The Library at CIRCOT has a total of 6857 books and 7846 bound volumes of Journals. The library subscribes to 29

Indian and 24 foreign journals. The library also subscribes to CDROM databases of Indian and ASTM Standards, AATCC, TAPPI and World Textile Abstracts. CIRCOT continued to be recognised as a post graduate institution affiliated to the Mumbai University.

During the year under review, twenty nine projects, including externally aided programmes were in operation under different core areas.

During the period under report one IRC, one RAC and one Institute Management Committee Meetings were held.

The following Seminars/Workshops were conducted during 2008-2009 :

- An awareness Workshop was conducted on clean cotton picking and on-farm storage under Cotton Value Chain project at Kothampaddi village near Attur in Salem District, Tamil Nadu, on July 3, 2008.
- The Fourth Review Meeting of the CFC funded project on Utilisation of Cotton Stalks for Value Added Products was held on August 30, 2008.
- Hindi Day/Fortnight Celebrations was organised during September 15 – 23, 2008.
- Farmers Awareness Meet was held at Vadapudur village in Pollachi, Tamil

- Nadu, on September 26, 2008 for promotion of clean cotton picking and on-farm storage.
- Farmers Awareness Meet was organised at Babhulgaon in Yeotmal District, Maharashtra on October 7, 2008 for promotion of clean cotton picking and plant byproduct utilisation.
 - The Vigilance Awareness Week was celebrated at CIRCOT, Mumbai from November 3 – 7, 2008.
 - A Clean Cotton Picking and Cotton Stalk Utilisation Workshop was held at Babhulgaon, Yeotmal District, Maharashtra on November 18, 2008.
 - Quami Ekta Week was celebrated at the Institute from November 19 – 25, 2009.
 - Another awareness workshop on Clean Cotton Picking was conducted on December 2, 2008 at Vadapudur village in Pollachi, Tamil Nadu.
 - Launch Workshop of the NAIP Project on Synthesis and Characterization of Nano-Cellulose and its Application in Biodegradable Polymer Composites to Enhance their Performance was held on December 3, 2008.
 - Launch Workshop of the NAIP project on Zonal Technology Management and BPD unit was held on January 24, 2009.
 - National Science Day was celebrated on February 28, 2009 with a lecture by Shri B.B. Daundkar, Dy. Director, Forensic Laboratory, Mumbai on Recent Developments in Forensic Science.
 - On the occasion of the International Women's Day on March 9, 2009 Kum. Najma, Advocate, Indian Centre for Human Rights and Law, Mumbai gave a talk on Womens' Rights in Government Establishments.
 - A six days training was imparted to the Supporting Staff from March 16-21, 2009 on matters pertaining to general administration and accounts.

Research Highlights : Under a study on Design and Development of Barcode Technology for Tagging Cotton Bales a computerised software namely 'Cotton Bale Manager' has been developed to perform two important functions viz. 1.) Design and generation of bale identification tag and 2) Computer interfacing of bale tags and management of bale database including the information about bale ID and its fibre quality parameters. The software generates an unique bar-coded customized label for every individual bale and is integrated with bale information along with its fibre properties. Also the user can edit, save, and print the specific labels along with search facility to access information on designed labels. The software can read the bale bar-coded ID with the help of a barcode scanner. 'Cotton Bale Manager' also includes an integrated database which is interfaced with the bale bar-coded ID's. The designed software will open the record for the bale if information has been already entered for that ID or the user can also enter records for new bale IDs. User can also browse and search the database using different criteria.

A Cotton pre-cleaner based on axial flow principle has been designed and fabricated. The single cylinder pre-cleaner

EXECUTIVE SUMMARY

has a capacity to clean 7-10 quintals of seed cotton per hour. The fabricated three cylinder system consists of assemblies of different cylinder diameters with different spike lengths and an adjustable semicircular grid having grid bars spaced at 10 and 12 mm for each half length of the cylinder. The top cover is provided with suitable inlets and outlets. The guide plates are designed to be mounted on the inside surface of the top cover to guide the movement of the seed cotton along the axis of the cylinder. The feeder assembly is also fabricated for controlled feeding of the seed cotton to the pre-cleaner. The drive to the cylinder is provided with 2 Hp motor and geared motor of 0.5 Hp is also made available for the feeder. The machine speed could be varied between 225 to 400 rpm with the help of a variable frequency drive. The preliminary testing of the machine has been satisfactory confirming that the principle of axial flow could be effectively used for pre-cleaning of seed cotton.

Under the All India Coordinated Cotton Improvement Project (AICCIP) 6687 samples were tested at Mumbai and all other Regional Units. The technological report for 2007-08 was presented at the Annual Workshop of AICCIP held in April 2008. Apart from these, a large number of samples belonging to various agricultural trials were also evaluated for the fibre quality attributes.

Fifty-four standard cotton varieties were received during the year from different agricultural universities. All the samples were analysed for their fibre, spinning and yarn properties and results issued by way of Technological Circulars.

During the year 73 trade varieties of Indian cottons were received from different locations for the 2008-09 season. The fibre, spinning and yarn tests are being carried out on all these samples.

While developing a demand model for the consumption of cotton fibre in textile sector it was observed that the demand for raw cotton is a derived one which depends mainly upon the demand for cotton yarn, which in turn depends upon that of the cotton fabric in domestic and international markets. The cotton yarn price is found to be a better indicator of demand for cotton yarn compared to the utilization capacity of spinning industries. The new model shows a better fit with R square value of 0.98 and the forecast stability of the model was better with Root Mean Squared Error (RMSE) value of 93.61 and the Thiel's inequality coefficient at around 0.019. The export demand for raw cotton was fitted as a function of domestic price of cotton, international price of cotton after adjusting for exchange rate variations, beginning stock, world cotton consumption and the domestic production to consumption ratio. This model showed a better fit with R square value of 0.91. The forecasted values for "out of sample period" was made using the model and compared with the actual consumption. The model based forecast was also compared with forecast using exponential smoothing technique and found to perform better.

The fabrication of an Instrument for Measurement of Electrical Properties of Textile Materials has been completed. The performance of this instrument was judged by testing different kinds of textile

samples. About 25 fabrics have been tested so far. For each test five readings at four varying voltages were taken. It was found that the control fabrics have the electrical resistance in the range of 10^9 to 11^{11} ohms with an accuracy of $\pm 2\%$ of the reading.

For a study on the structure-property relationship in friction spun yarns (DREF), 17 DREF yarn samples of various core (nylon6) and sheath (cotton) ratios ranging from 14 – 71% were produced by using the DREF-3000 machine. While preparing the first 9 yarn samples, different rates of sheath (inlet) were given, so that the effect of various inlets on tensile properties of a fixed count could be studied. The tensile properties of these yarn samples such as breaking strength, elongation %, work of rupture and tenacity were estimated. From the analysis of data no significant effect was noted for various inlets of sheath on the tensile properties of a fixed count DREF yarn. Tensile properties depended upon the core ratio of DREF yarns and increased with core ratio.

For Preparation and Marketing of CIRCOT Calibration Cotton Standards, one bale each of two cotton samples viz. Jayadhar and DCH.32 were purchased from Dharwad and Sindhanur in Karnataka and processed to prepare calibration cotton standards. Testing of these cottons for fibre properties was carried out. Inter Laboratory Test No.13 has been completed. Making use of the results of Inter Laboratory Tests and in-house test results, the standard values have been assigned and these samples have been introduced as new cotton standards viz. HM- 9 and HE- 8. During the year under

report, 796 containers of calibration cotton were sold and an amount of Rs. 4,45,321/- as revenue was generated. This year 27 new HVI units have joined the list of users of calibration standards of CIRCOT.

Under the NAIP funded project entitled "A Value Chain for Cotton Fibre, Seed and Stalk: An Innovation for Higher Economic Returns to Farmers and Allied Stake Holders" an ELS cotton hybrid RCHB.708 Bt. was grown in Vadapudur village in Coimbatore district, Tamil Nadu, and Bunny Bt. cotton at Babulgaon in Yeotmal district of Maharashtra. More than 130 farmers were associated in the project. Cultivation know-how and supervision has been provided by the Scientists from CICR. Importance of clean cotton picking, proper storage and transportation were highlighted to farmers by CIRCOT scientists. About 700 quintals of *kapas* procured at Coimbatore and about 350 quintals of *kapas* at Nagpur. were ginned at respective places. Sixty-seven bales have been pressed at Nagpur and 147 at Coimbatore. Almost no contamination is observed as a result of awareness created among farmers about clean cotton picking by CIRCOT and about 15% increase in *kapas* yield is reported by the participating farmers. Fibre samples from each bale were collected and evaluated for fibre parameters using the HVI. Bales at Nagpur have already been tagged with these fibre attributes. Cotton stalk in the farmers' fields at Nagpur have been cleaned of boll rinds. Chipping operation is in progress. Delinting of ginned seed using enzyme pre-treatment has been carried out on an experimental scale.

EXECUTIVE SUMMARY

CIRCOT is a consortium partner for a project on "A Value Chain on Banana Pseudostem for Fibres and Other Value Added Products". under component 2 of NAIP. The objectives of the project are to standardise a process for extracting textile grade fibres from pseudostem and prepare home furnishing, to standardise a process for pulp and paper making from pseudostem, fibres and waste both at hand made and industrial levels, to develop value added edible products from the central core, prepare and evaluate enriched sap and scutching waste vermi compost and develop linkage for marketing of pseudostem based products. A Raspador was installed at Navsari Agricultural University, Navsari. Standardization of machine parameters has been completed. Extraction trials were taken up successfully. The effect of microbial retting on softening of banana fibres as well as extraction of fibres from sheaths by a microbial treatment were carried out; preliminary trials were undertaken to treat ready-to-dye cotton fabric with sap as a mordant for application of natural dyes.

The project entitled "Design and Development of Rubber Dams for Watersheds" under NAIP Component 4, for which CIRCOT is a consortium partner aims at developing an indigenous rubber check dam to be installed in the watersheds. CIRCOT has been instrumental in developing a suitable fabric having optimum strength and flexibility to be bonded with the rubber component. An appropriate adhesive latex formulation has been developed and nine fabric samples were produced by using Nylon which provided a good peel strength.

Based on the various experiments, GSM and quantum of adhesive application have been optimized. Mock leno showed higher peel strength than other weaves with similar material, due to its more porous structure enabling better penetration of adhesive material. A fabric sample could be recreated based on the analysis done on fabric substrate separated from rubber pieces, which were collected from Janjavathi Rubber Dam site following reverse engineering principles. This activity demonstrated that it is possible to produce heavy duty fabric geo-membrane indigenously for use in large dams on rivers. Technical specifications of fabric reinforcement were arrived at and fixed for fabricating proto dams to be used in the watersheds.

For production of xylanase by *Aspergillus niger* sp. through solid state fermentation and its application to lignocellulosic materials, the xylanase produced was concentrated by ultrafiltration and acetone precipitation methods. The results showed that the enzyme concentration was increased by four fold while the specific activity (xylanase activity/mg protein) was enhanced by 3.3 fold. Various lignocellulosic materials viz. cotton stalks, wheat straw, rice straw, bajra straw were hydrolysed by cellulase and a mixture of cellulase and *A. niger* sp. xylanase for 24 h and a 48 h and production of reducing sugars was estimated. The results indicated that xylanase from *A. niger* sp. could hydrolyse hemicellulose present in the lignocellulosic materials. It was also observed that xylanase can degrade the lignocellulosic materials.

Under a study on DP Finishing of

Dyed Fabric, both dyed and treated fabrics were subjected to estimation of fabric handle and comfort properties. For samples treated with reactive blue and red dyes, it was observed that for each of the three different shades at a pH of 3.5 the fabrics gave the highest value for Koshi (stiffness). At the same time, the Numeri (Smoothness) was observed to decrease for fabrics treated at pH 3.5 as compared to pH 4.5. In the case of red dyed fabric, Fukurami (fullness and softness) was noted to decrease after treatment, while for the blue dyed fabric it showed an increase for the treatment at pH 3.5. The air-permeability was observed to increase for both blue and red dyed fabrics. The moisture transport for 1.5% dyed fabric showed an increase after treatment for both the dyed fabrics. On the other hand 3% dyed fabric showed a decrease in the moisture transport after treatment. Thermal insulation value for the red dyed fabric was noted to be higher than the blue dyed fabric for control as well as for treated samples. Scaling up trials were conducted to have durable press finish. Treatment with Polycarboxylic acid as cross linking agent was carried out both on dyed as well as printed fabrics. DP finished fabrics showed good colour strength, durable press, breaking strength and comfort properties as compared to control. The handle properties of treated fabrics showed better resiliency. In the case of both dyed and printed samples, the treated fabrics presented a much smoother surface compared to their control. The treated fabrics displayed reduced stiffness (koshi) and softness (Fukurami) values. The surface smoothness (Numeri) was seen to improve with treatment. The treatment

did not result in any deterioration in the fabric hand.

Woven and knitted fabrics prepared from organic cotton were evaluated initially for their physical properties without any treatment for a study on Ecofriendly Pre and Post Processing of Fabric Prepared from Organic Cotton and Finishing with Chitosan. Both woven and knitted fabric samples were scoured with pectinase and bleached with hydrogen peroxide. Simultaneously, the fabrics were also scoured by the kier boiled process and bleached with hydrogen peroxide. All the fabric samples were evaluated for various physical and mechanical properties. The results indicated that the absorbency was instantaneous in bioscoured as well as conventionally scoured fabric samples. Chitosan treatment was given to the bioscoured and bleached woven fabric sample and evaluated for antibacterial activity. A 99% reduction in bacterial count was observed. When woven and knitted fabrics scoured and bleached were dyed with chrysanthemum flowers, K/s value of enzymatically scoured and bleached fabric sample was slightly higher than that of the conventionally scoured and bleached fabric.

Under a study on development of protective clothing for pesticide spraying operation two medium weight plain weave 100% cotton grey fabrics were tested for pesticide repellency, retention and penetration against 5% pendimethalin solution. Repellency was not observed. Desizing reduced the pesticide penetration, perhaps due to increased absorbency but it was still much higher than the acceptable range of 5-40%. Five

EXECUTIVE SUMMARY

more grey 100% cotton fabrics of different construction and weight per square metre were procured and subjected to one and five hand washes as per AATCC 135-2004 standard procedure. Wetting time of washed samples determined by drop absorbency method ranged from 23 sec. to > 180 sec. for fabrics washed once and < 1 sec. to 35 sec. for fabrics washed five times. All washed samples were tested for percent pesticide penetration, retention and repellency against 5% pendimethalin solution. Pesticide penetration through samples washed once ranged from 22%-44% while it ranged from 17%-35% for samples washed five times which was within the acceptable range. As expected, heaviest fabric showed lowest pesticide penetration.

Titania nanoparticles have been synthesized by using two different precursors namely titanium isopropoxide and titanium IV chloride and starch as stabilizing agent for a study on production of titanium dioxide nanoparticles and their application in cotton textiles for antibacterial and self-cleansing properties. These materials were washed with water and calcined at 400°C to get crystalline titania. The product was characterized by X-ray diffraction, UV-visible spectrophotometer and spectrofluorimeter. Nano-titania showed blue shift in absorption spectrum due to increase in band gap at nanoscale. As the size decreased, the absorption maximum shifted towards the UV region (blue-shift). The size of the nano-titania was estimated by DLS (dynamic light scattering) particle size analyser and confirmed by using the transmission electron microscopy. Two different morphologies (rod and spherical)

of nano-titania were noticed in TEM images.

A project under Component 4 of NAIP on Synthesis and characterization of nano-cellulose and its application in biodegradable polymer composites to enhance their performance was undertaken with the objective of preparing nano-cellulose (nanowhiskers and nanofibrils) from cotton and cotton linters by novel microbial, enzymatic and chemo-mechanical processes and their characterization and also for preparing polymer nano-cellulose composites and to evaluate their mechanical, barrier and biodegradability attributes. Microcrystalline cellulose (MCC) was prepared from 'Bengal Desi' cotton fibres by conventional dilute acid hydrolysis (2.5N HCl; 100°C). When Fenton's chemistry was tried on MCC to loosen the surface chemical structure no enhancement in enzymatic activity was noticed with Fenton's reagent treated MCC up to the ratio of 10:1:30. In contrast, reduction in enzymatic activity was noticed that may be attributed to the inhibitory effect of 'Fe' element present on the surface of MCC. The fungus, *Trichoderma reesei* was used for the hydrolysis of MCC under submerged fermentation condition. Both the cellulase activity and particle size distribution were monitored up to 5 days. The formation of nano-cellulose was found after 24 h of fermentation. Very fine sized particles (<100 nm) were formed after 5 days of incubation. The fibrillation could be achieved only by the refining process. The average size of control fibre was around 25 microns while that of refined fibres was in the range of 63 - 642 nm. The yield of micro fibrils was 44 percent after 30

passes through lab disc refiner. Starch was modified by carboxy-methylation and gelatinized along with glycerol. This was casted on the Teflon coated glass plates and dried in vacuum oven for film formation. For nano composites films, the nano cellulose suspension was added along with starch slurry and the film was formed. Two different process conditions were tried for the formation of nano composites films. Mechanical properties like tensile strength and elongation at break were analyzed for both control and nano composites films. A tensile strength values of 99 and 103 Mpa and elongation at break of 24 and 26 % were recorded for control and nano composite films, respectively.

For determination and characterisation of oil and protein in Bt. cottonseeds, sixty Bt. Cotton seed samples pertaining to F1 and F2 generation were procured and evaluated for oil content. Eighteen samples were evaluated for protein content and fatty acid profile as well. Test results indicated a reduction in oil content in F2 generation seeds belonging to J.K. Seeds Co., while, a reverse trend was noticed in the seed samples of Cotton Research Station (Surat) and UAS, Dharwad. The oil content in F2 generation seeds of these samples was considerably higher as compared to F1 seeds. Further, it is worth noting that the oil content in the Bt. cotton seed samples of NAU, Navsari and UAS, Dharwad was unusually, but consistently higher. No specific trend was noticed in the protein content of F1 and F2 seeds except in a few F2 samples wherein a slight reduction in protein content was noticed. In general protein content of J. K. Seeds

and Cotton Research Station (Surat) was found to be on the lower side. Efforts are on to relate the gene/event profile and the seed oil content in Bt seed samples.

Cottonseeds of Bunny Bt. were procured and delinting and dehulling were carried out for preparing value added products from cottonseed meal by extrusion cooking. Cottonseed meal was taken and sieved into two fractions. Cottonseed cake samples were prepared from whole cottonseed kernels by passing through expeller for extraction of oil. These samples were taken and powdered and mixed with cassava flour in the ratios 20:80, 30:70 and 40:60. Moisture stabilization was done by adding water making the moisture content to 16%. The samples were passed through the extrusion cooker. The cooker temperature was kept at 85°C and the die temperature was varied from 150-180°C. The puffing was observed to be less with 40 % cottonseed and the colour grade was observed to be comparable. The 20:80 and 30:70 samples (Meal : Cassava flour) were observed to be comparable in terms of the colour grade and puffing.

Under the project entitled "Utilisation of Cotton Plant By-produce for Value Added Products" cotton stalk collection, chipping and transportation were entrusted to an identified private party at Nanded. A chipper and tractor were procured and installed in a place near Nanded and mobilised the cotton stalk supply. The stalks were chipped and transported to M/s. Godavari Particle Board Industry. About 500 tonnes of chips were supplied at a cost of Rs. 1500 per tonne. Awareness meets were conducted near Coimbatore and Nagpur

EXECUTIVE SUMMARY

to highlight the importance of cotton stalks to the farming community as an income providing raw material. In an effort to utilise all the available crop residues in the cotton belt, blending trials were undertaken using mulberry stalks and bagasse. The results indicated that boards of acceptable quality could be prepared.

For a study on commercial technology development for value addition to cotton plant by-produce under MM1 4.2 of TMC, trials were undertaken on the prevention of fungi elaborating aflatoxin during cottonseed storage and the results indicated that spraying seeds with 1% propionic acid inhibited the fungal growth for a period of six months. One hundred kg trial was extended to one tonne trial and samples withdrawn at monthly intervals indicated a significant reduction in the fungal population. Simultaneously, trials are also underway on spraying microbial consortium made to form propionic acid on vegetable wastes with other enzymes *viz.* pectinases.

The Indian Council of Agricultural Research under the National Agricultural Innovation Project scheme has recently set up a Zonal Technology Management and Business Planning & Development (BPD) unit at CIRCOT, Mumbai. Initially ZTM-BPD-CIRCOT will be concentrating on technologies available with CIRCOT and other ICAR Institutes in the western zone. In the near future, ZTM-BPD-CIRCOT will assist the incubatee's in creating

entrepreneurship based on his own idea.

Extension Activities : The Director and scientists of CIRCOT continued as members of various committees of BIS for cotton and textile testing, and in various panels of organisations like ATIRA, BTRA, SITRA, UICT, etc. Some of the key extension activities of CIRCOT during the period were (i) supply of accurate and reliable data on quality aspects of fibres, yarns and fabrics, (ii) consultancy services, (iii) publication of research results by way of scientific papers, leaflets and booklets for the benefit of the appropriate user groups and (iv) dissemination of technical information through training programmes.

The testing house received over 6084 samples of fibre, yarn and fabric for different kinds of tests while at the Regional centres about 3000 samples were tested. Training courses on cotton quality evaluation were conducted at the headquarters for about 74 persons engaged in textile trade and industry. This includes special courses on HVI and AFIS instruments organised for appropriate user groups. At GTC, Nagpur, around 119 sponsored personnel were trained on various aspects of cotton ginning. CIRCOT also participated in various exhibitions to popularise the technologies developed at the Institute. The resource generation at CIRCOT during 2008-09 by commercial sample testing, consultancy research, training and revolving fund activities was Rs. 65.71 lakhs.

सार संक्षेप

यह केन्द्रीय कपास प्रौद्योगिकी अनुसंधान संस्थान के कार्यकलापों की 1 अप्रैल, 2008 से 31 मार्च, 2009 तक की पचासीवीं (85वीं) वार्षिक रिपोर्ट है।

भूमिका

केन्द्रीय कपास प्रौद्योगिकी अनुसंधान संस्थान (सिरकॉट) की स्थापना भारतीय केन्द्रीय कपास समिति के अंतर्गत सन् 1924 में प्रौद्योगिक प्रयोगशाला के रूप में हुई। भारतीय कृषि अनुसंधान परिषद ने सन् 1966 में इस प्रयोगशाला को अपने प्रशासनिक नियंत्रण में ले लिया, जब भारतीय केन्द्रीय कपास समिति का अन्य व्यावसायिक समितियों के साथ समापन कर दिया गया। इस प्रयोगशाला का नाम बदलकर कपास प्रौद्योगिकी अनुसंधान प्रयोगशाला रखा गया। भारतीय कृषि अनुसंधान परिषद के अनुसंधान कार्यकलापों को प्रधानता व नया मोड़ देने एवं कृषि अनुसंधान कार्यों में तेजी लाने के लिए नए सिद्धांत व आज्ञापत्र बनाये गये। 1 अप्रैल, 1991 को इस संस्थान का नाम पुनः बदलकर केन्द्रीय कपास प्रौद्योगिकी अनुसंधान संस्थान रखा गया, जो संस्थान का वर्तमान नाम है।

केन्द्रीय कपास प्रौद्योगिकी अनुसंधान संस्थान ने अखिल भारतीय समन्वित कपास सुधार परियोजना (ए.आई.सी.सी.आइ.पी.) के अंतर्गत तकनीकी सहभागी के रूप में काम करते हुए इस वर्ष लगभग 6500 से अधिक कपास के नमूनों की गुणवत्ता परीक्षण एवं साथ ही कई नमूनों का कटाई परीक्षण भी किया।

वर्तमान वर्ष के दौरान देश के विभिन्न कपास प्रजनकों से प्राप्त 3000 से भी अधिक कपास के नमूनों का तन्तु परीक्षण मुख्यालय में किया गया, जबकि संस्थान के क्षेत्रीय गुणवत्ता मूल्यांकन इकाईयों में प्रयोग की प्रारंभिक अवस्थाओं से प्रजनित लगभग 20,000 से भी अधिक कपास के नमूनों की तन्तु गुणवत्ता का परीक्षण किया गया।

संस्थान के पुस्तकालय में कुल 6857 पुस्तकें एवं 7846 जिल्द लगे जर्नल हैं। संस्थान के पुस्तकालय को 29 भारतीय एवं 24 विदेशी जर्नल की सदस्यता प्राप्त है और ये सब जर्नल नियमित रूप से उपलब्ध हैं। साथ ही संस्थान के पुस्तकालय में भारतीय व ए.एस.टी.एम. मानक के सीडी रोम डाटाबेस एवं ए.ए.टी.सी.सी., टी.ए.पी.पी.आई व वर्ल्ड टेक्सटाइल सारांश भी उपलब्ध हैं। इस संस्थान को मुंबई विश्वविद्यालय के अधीन स्नातकोत्तर संस्थान के रूप में मान्यता प्राप्त है।

संस्थान में रिपोर्ट की अवधि के दौरान बाह्य निधि की मदद से चल रहे कार्यक्रमों को मिलाकर विभिन्न कोर क्षेत्रों में कुल उनतीस परियोजनाओं के तहत शोधकार्य जारी रहे।

रिपोर्ट की अवधि के दौरान संस्थान में एक आई.आर.सी., एक आर.ए.सी. तथा एक प्रबंधन समिति की बैठकों का आयोजन हुआ।

संस्थान में वर्ष 2008-2009 के दौरान निम्नलिखित

सम्मेलनों एवं कार्यशालाओं का आयोजन किया गया।

1. कॉटन वैल्यू चेन (एन.ए.आई.पी.) परियोजना के अंतर्गत अत्तूर के समीप ग्राम कोथमपडी, जिला - सलेम, तमिलनाडु में स्वच्छ कपास की चुनावी एवं खेतों में भंडारण विषय पर जागरुकता कार्यशाला दिनांक 3 जुलाई, 2008 को आयोजित की गई।
2. सी.एफ.सी. के अनुदान से कपास डंठलों के बेहतर मूल्य संवर्धित उत्पाद परियोजना की चौथी पुनरवलोकन बैठक का आयोजन दिनांक 30 अगस्त, 2008 को हुआ।
3. संस्थान में 15 से 23 सितंबर, 2008 के दौरान हिन्दी दिवस/पखवाड़ा मनाया गया।
4. तमिलनाडु में पोलाची के निकट वड़ापुदुर गाँव में स्वच्छ कपास की चुनावी एवं खेतों में इसके भंडारण को बढ़ावा देने के लिए किसानों की जागरुकता बैठक का आयोजन दिनांक 26 सितंबर, 2008 को किया गया।
5. महाराष्ट्र में यवतमाल जिले के बाभुलगाँव गाँव में स्वच्छ कपास की चुनावी एवं पौधों के उपोत्पादों के बेहतर उपयोग को बढ़ावा देने के लिए किसानों की जागरुकता बैठक दिनांक 7 अक्टूबर, 2008 को हुई।
6. संस्थान, मुंबई में 3 से 7 नवम्बर, 2008 के दौरान सतर्कता जागरुकता सप्ताह मनाया गया।
7. स्वच्छ कपास की चुनावी एवं कपास डंठलों के बेहतर उपयोगिता विषयों पर गाँव -बाभुलगाँव, जिला यवतमाल, महाराष्ट्र में दिनांक 18 नवम्बर, 2008 को कार्यशाला आयोजित की गई।
8. संस्थान में कौमी एकता (साम्प्रदायिक सद्भावना) सप्ताह 19-25 नवंबर, 2008 के दौरान मनाया गया।
9. पोलाची के समीप वड़ापुदुर गाँव, तमिलनाडु में स्वच्छ कपास की चुनावी पर दिनांक 2 दिसंबर, 2008 को एक और कार्यशाला आयोजित की गई।
10. “सिंथेसिस एवं कैरेक्टेराइजेशन ऑफ नॅनो-सेल्यूलोज एवं उनके निष्पादन बढ़ाने के लिए जैव-अपघटक पॉलिमर कम्पोजिट में प्रयोग” एन.ए.आई.पी. परियोजना की उद्घाटन कार्यशाला 3 दिसम्बर, 2008 को हुई।
11. “जोनल प्रौद्योगिकी प्रबंधन एवं बी.पी.डी. यूनिट” एन.ए.आई.पी. परियोजना की उद्घाटन कार्यशाला दिनांक 24 जनवरी, 2009 को आयोजित की गई।
12. श्री बी.बी. दौंडकर, उपनिदेशक, फोरेन्सिक लैबोरेटरी, मुंबई के व्याख्यान “फोरेन्सिक विज्ञान में नवीनतम विकास” के साथ राष्ट्रीय विज्ञान दिवस 28 फरवरी, 2009 को मनाया गया।
13. अंतर्राष्ट्रीय महिला दिवस 9 मार्च, 2009 के दिन कुमारी नजमा, वकील, मानवीय अधिकार एवं कानूनी भारतीय केन्द्र, मुंबई द्वारा “सरकारी स्थापनाओं में महिलाओं के अधिकार” विषय पर चर्चा के साथ मनाया गया।
14. संस्थान के सपोर्टिंग कर्मचारियों को सामान्य प्रशासनिक एवं वित्तीय विषयों की जानकारी के लिए मार्च 16-21, 2009 के दौरान छः दिनों का प्रशिक्षण दिया गया।

विशिष्ट शोधकार्य :

“कपास की गांठों के लेबल के लिए बार-कोड तकनीक की योजना एवं विकास” परियोजना के अंतर्गत “कॉटन बेल मैनेजर” नामक कम्प्यूटराइज सॉफ्टवेयर दो मुख्य कार्यों के निष्पादन के लिए विकसित किया गया - 1) गांठों के पहचान के लिए लेबल का निर्माण एवं 2) कपास के गांठों की पहचान एवं रेशों की गुणवत्ता के डाटाबेस के बेहतर प्रबंधन के लिए कम्प्यूटर - इन्टरफेसिंग। इस सॉफ्टवेयर के द्वारा अलग-अलग कपास की गांठों के लिए अलग-अलग बार-कोड द्वारा वर्गीकरण किया जा सकता है साथ ही उसमें तन्तु गुणवत्ता की सूचना भी उपलब्ध रहती है। इसमें इस्तेमाल करने वाले डाटा को एडिट, बचत एवं प्रिन्ट कर सकते हैं एवं सर्च की सुविधा के उपयोग द्वारा अपने जरूरत के गांठ की जानकारी भी प्राप्त कर सकते हैं। बार-कोड स्कैनर के द्वारा इस सॉफ्टवेयर में गांठ की बार-कोड की पहचान पढ़ी जा सकती है। ‘काटन बेल मैनेजर’ साफ्टवेयर में गांठ की बार-कोड पहचान उनमें निहित डाटाबेस के साथ जुड़ी हैं। यह विकसित सॉफ्टवेयर गांठों की बार-कोड पहचान भरने पर भी खुलता है एवं उपयोग करने वाले इसमें नये गांठों के लिए डाटा भर भी सकते हैं। इसके द्वारा कई तरीकों के इस्तेमाल से गांठों की जानकारी शामिल हो सकती है।

एक्सियल फ्लो (केन्द्रीय बहाव) सिद्धान्त पर आधारित एक नये कॉटन प्री-क्लीनर की योजना बनाकर विकसित किया गया। इस एकल-बेलन प्री-क्लीनर की क्षमता 7-10 क्विंटल सीड कॉटन प्रति घंटे है। तीन बेलनों वाले निर्मित सिस्टम में बेलनों के विभिन्न व्यास एवं उनमें लगे कांटों की लम्बाई भी विभिन्न होती है। इसमें व्यस्थित करने वाले अर्धवृत्तिय ग्रिड होते हैं जो

बेलन के प्रति आधी लंबाई पर 10 से 12 मिलीमीटर की दूरी पर अवस्थित होते हैं। इसके ऊपरी कवर पर इनलेट व आउटलेट बने होते हैं। कपास को बेलन की केन्द्र की ओर दिशा देने के लिए गाइड प्लेटों की योजना एवं उनका विकास किया गया। प्री-क्लीनर तक सुचारु व नियमित सीड-कॉटन उपलब्ध कराने के लिए फीडर-असेम्बली निर्मित की गई। सिलेन्डर को चलाने के लिए 2 एच.पी. (अश्व-शक्ति) का एवं फीडर-असेम्बली के लिए 0.5 एच.पी. का मोटर लगाया गया। परिवर्तनशील बारंबारता चालक के उपयोग द्वारा मशीन की गति 225 से 400 आर.पी.एम. (परिक्रमण प्रति मिनट) के बीच रखी गयी। मशीन की प्रारंभिक परीक्षणों के संतोषजनक परिणामों से ये साबित हुआ कि सीड-कॉटन की उत्तम प्री-क्लीनिंग के लिए केन्द्रीय - बहाव सिद्धान्त उपयोगी है।

अखिल भारतीय समन्वित कपास सुधार परियोजना (ए.आई.सी.सी.आई.पी.) के अंतर्गत सिरकॉट, मुंबई एवं इसकी क्षेत्रीय इकाइयों में कुल मिलाकर 6687 कपास के नमूनों का परीक्षण किया गया। वर्ष 2007-08 की तकनीकी वार्षिक रिपोर्ट अप्रैल, 2008 के दौरान वार्षिक कार्यशाला में प्रस्तुत की गयी। इसके अतिरिक्त विभिन्न एग्रीकल्चरल ट्रायल के अनेक कपास के नमूनों का गुणवत्ता परीक्षण किया गया। साल के दौरान चौवन मानक कपास प्रजातियों के नमूने विभिन्न कृषि विश्वविद्यालयों से प्राप्त हुए। इन सभी नमूनों के तंतु-परीक्षण, कताई एवं सूत-गुण परीक्षण किये गए एवं परिणाम तकनीकी परिपत्रों के माध्यम से जारी किये गये।

वर्ष 2008-2009 के दौरान भारतीय कपास की 73 व्यावसायिक प्रजातियाँ देश के विभिन्न केन्द्रों से प्राप्त हुईं। इन सभी कपास के नमूनों के रेशे, कताई व

सूत परीक्षण किये गये ।

टेक्सटाइल क्षेत्र में कपास रेशों की खपत का डिमांड-मॉडल विकसित करते वक्त यह पाया गया कि कपास के कच्चे माल की मांग मुख्यतः कपास के सूत की मांग पर निर्भर है और साथ ही घरेलू एवं वैश्विक बाजार में सूती वस्त्रों (100 प्रतिशत कॉटन) की मांग पर भी निर्भर है । कताई उद्योग की क्षमता की तुलना में कपास सूतों के मूल्य बाजार में कपास के सूतों की मांग का बेहतर निर्धारण करते हैं । नये मॉडल के अनुसार पाया गया कि ये आर के वर्ग मान 0.98 में सही बैठता है और भविष्यवाणी स्थिरता मॉडल वर्गमूल औसत वर्ग गल्ली (आर.एम.एस.ई.) के 93.61 मान एवं थियल के असमानता गुणांक के 0.019 मानों के लिए उपयुक्त है । कपास के कच्चे माल की निर्यात - मांग का निर्धारण कपास के घरेलू मूल्य, एक्सचेंज दर में बदलाव को ध्यान में रखते हुए कपास का वैश्विक मूल्य, प्रारंभिक स्टॉक, वैश्विक कपास खपत एवं घरेलू उत्पादन - खपत अनुपात के आधार पर किया गया । यह मॉडल आर के वर्ग मान 0.91 के लिए उपयुक्त पाया गया । इस मॉडल के द्वारा पूर्व निर्धारित मान नमूने समय से बाहर के लिए प्राप्त किए गए एवं वास्तविक खपत के साथ तुलना किये गए । मॉडल पर आधारित भविष्यवाणी की तुलना एक्सपोनेन्सियल समतलता तकनीक द्वारा भविष्यवाणी से की गयी और उत्तम पायी गई ।

टेक्सटाइल वस्तुओं के विद्युत गुणधर्म की माप के लिए एक यंत्र के निर्माण का कार्य पूरा हो गया । इस यंत्र की निष्पादन क्षमता जाँचने के लिए विभिन्न प्रकार के वस्त्रों के नमूनों के परीक्षण किए गए । अब तक लगभग 25 वस्त्रों के नमूनों का परीक्षण किया जा चुका है । इस वस्त्रों के नमूनों के लिए वोल्टेज बदल-बदल कर प्रत्येक परीक्षण के पाँच-पाँच मान निकाले गए ।

यह पाया गया कि बगैर उपचारित वस्त्रों का विद्युत प्रतिरोध मान + 2% की शुद्धता के साथ 10^9 से 10^{11} ओम के रेंज में है ।

ड्रेफ - 3000 मशीन द्वारा घर्षण विधि से कताई किये सूतों की संरचना-गुणों के अध्ययन के लिए 17 ड्रेफ सूत बनाए गये, जिनके विभिन्न कोर (नायलोन 6) एवं शीथ (कपास) 14-17% तक रेंज में प्रयोग किए गए । प्रारंभिक 9 सूत-नमूनों के निर्माण के दौरान शीथ (इनलेट) विभिन्न दरों से डाले गए, ताकि नियत-काउन्ट के लिए तन्यता गुणों का विभिन्न इनलेट के लिए अध्ययन किया जा सके । इन सूतों के नमूनों के तन्यता गुणों में टूटने की शक्ति, खिंचाव % , वर्क ऑफ रफ़र, एवं तन्यता आदि मापे गए । इन डाटाओं के विश्लेषण से नियत काउन्ट के ड्रेफ-सूतों की तन्यता गुणधर्मों में विभिन्न इनलेट का कोई विशेष प्रभाव नहीं पाया गया । यह पाया गया कि ड्रेफ सूतों के तन्यता गुण कोर-अनुपात पर निर्भर करते हैं और उनके बढ़ने पर बढ़ते हैं ।

सिरकॉट के अंशशोधन मानक कपास की मार्केटिंग एवं निर्माण के लिए एक-एक गांठ दो कपास के नमूने जयाधर एवं डी.सी.एच.32 कर्नाटक के धारवाड एवं सिंघनूर से खरीदे गए एवं इनके प्रक्रम के पश्चात अंशशोधन मानक कपास तैयार किये गए । इन कपासों के रेशा-गुणों का परीक्षण किया गया । इंटर लैबोरेटरी टेस्ट नं. 13 भी पूरा किया गया । इंटर लैबोरेटरी एवं इन-हाउस परीक्षण परिणामों के आधार पर मानक स्थापित किये गए एवं इन नमूनों को नये कपास के मानक एच.एम.9 एवं एच.ई.8 के रूप में प्रस्तावित किया गया । इस वर्ष के रिपोर्ट की अवधि के दौरान अंशशोधन मानक कपास (कैलिब्रेशन कॉटन) के 796 डब्बे बेचे गए जिनसे रुपये 4,45,321/- की राशि अर्जित हुई । इस वर्ष 27 नये एच.वी.आई.यूनिट

सिरकॉट अंशशोधन मानक कपास की उपभोक्ता सूची में जुड़ गए ।

एन.ए.आइ.पी. अनुदान की “कपास रेशे, बिनौले और डंठलों के लिए मूल्य कड़ी : किसानों एवं संबंधित (स्टेक होल्डर) साझेदारों के लिए उच्च आर्थिक लाभ का नवोन्मेष” नामक परियोजना के अंतर्गत अधिक तंतु लम्बाई (इ.एल.एस.) के संकर कपास की प्रजाति आर.सी.एच.बी. 708 बीटी ग्राम - वड़ापुदुर, जिला - कोयमबतूर, तमिलनाडु में एवं बन्नी बीटी कपास ग्राम - बाबुलगांव, जिला - यवतमाल, महाराष्ट्र में उपजाये गये । इस परियोजना में लगभग 130 से अधिक कृषक सहभागी बने । खेती के बारे में जानकारी एवं देख-भाल सी.आइ.सी.आर के वैज्ञानिकों द्वारा निष्पादित किए गए । किसानों को स्वच्छ कपास की चुनाई, उचित भंडारण एवं परिवहन आदि के बारे में सिरकॉट के वैज्ञानिकों द्वारा सुझाव व परामर्श दिए गए । लगभग 700 क्विंटल कपास कोयमबतूर से एवं लगभग 350 क्विंटल कपास नागपुर से खरीदे गये एवं उनको ओटाई के लिए भेजा गया । ओटाई प्रक्रिया के पश्चात संरसठ गांठ नागपुर में एवं एक सौ सैंतालिस गांठें कोयम्बतूर में तैयार की गई । सिरकॉट द्वारा किसानों में स्वच्छ कपास चुनाई की जागरुकता जगाने के परिणामस्वरूप कपास में न के बराबर अशुद्धियाँ पायी गईं एवं सहभागी कृषकों द्वारा कपास के उत्पादन में लगभग 15% वृद्धि भी दर्ज करायी गयी । एच.वी.आई. द्वारा प्रत्येक गांठों से एकत्र किये गये कपास के नमूनों का तंतु - परीक्षण किया गया । नागपुर के कपास की गांठों में रेशों के गुणधर्म दर्शाने वाले लेबल लगा दिये गये । नागपुर में कृषकों के खेतों से प्राप्त कपास के डंठलों से बीजकोष के छिलकों की सफाई की गई । कपास के डंठलों को तराशने का कार्य जारी है । ओटाई द्वारा प्राप्त बीजों

की एन्जाइम पूर्व - उपचारित प्रक्रिया द्वारा प्रायोगिक पैमाने पर वितंतुकीकरण किया गया ।

एन.ए.आइ.पी. के घटक 2 के अंतर्गत सिरकॉट “केला छद्मतना रेशा एवं अन्य मूल्य संवर्धित उत्पाद पर एक मूल्य कड़ी ” नामक परियोजना में कन्सोर्टियम पार्टनर है । इस परियोजना के उद्देश्य केले के तने से टेक्सटाइल के लिए उपयुक्त रेशा-निष्कर्षण की मानक प्रक्रिया स्थापित करना एवं घरेलू कपड़ों के निर्माण, केले के तने से गत्ते एवं कागज की लुगदी तैयार करने की मानक प्रक्रिया की स्थापना, हस्त-निर्मित एवं औद्योगिक निर्मित रेशे एवं अपशिष्ट तैयार करना, मध्य तने से मूल्य-संवर्धित खाद्य सामग्री का निर्माण, तनों के रस सहित वर्मी-कम्पोस्ट का मूल्यांकन एवं निर्माण एवं केले के तनों के उत्पादों के लिए मार्केट में सम्पर्क स्थापित करना है । नवसारी कृषि विश्वविद्यालय, नवसारी में एक रास्पाडोर स्थापित किया गया । यंत्र के मानकीकरण का कार्य संपादित कर लिया गया है । रेशों के निष्कर्षण के परीक्षण सफलतापूर्वक किये गये । केले के रेशों को जीवाण्विक रेटिंग प्रक्रिया द्वारा मुलायम करने एवं जीवाण्विक उपचार द्वारा छिलकों से रेशा निष्कर्षण करने के परीक्षणों के प्रभावों का अध्ययन किया गया । केले के रेशों को कपास के वस्त्रों की रंगाई के लिए प्राकृतिक रंजक के रूप में प्रयोग करने का प्रारंभिक परीक्षण भी किया गया ।

एन.ए.आइ.पी. के घटक 4 के अंतर्गत सिरकॉट “जलसंभरों (वाटरशेड) के लिए रबर डैम बनाने की योजना एवं विकास” नामक परियोजना में कन्सोर्टियम पार्टनर है एवं इस परियोजना का उद्देश्य जलसंभरों में देशी रबर डैम स्थापित करने का है । सिरकॉट ने इस परियोजना के तहत उपयुक्त मजबूती एवं फैलने व सिकुड़ने वाले वस्त्र विकसित किये हैं जो रबर के साथ

मजबूती से बंध बनाकर जुड़ जाएँ। एक उपयुक्त एडहेसिव लेटेक्स सूत्र का विकास किया गया एवं नायलोन का प्रयोग करके नौ उच्च पील-स्ट्रेन्थ वाले वस्त्र निर्मित किए गए, जिनके ग्राम प्रति वर्ग मीटर व एडहेसिव की मात्रा का अनुकूलन भी किया गया। मोक - लेनों में समान सामग्रियों के लिए अन्य बुनावटों से अधिक पील-स्ट्रेन्थ पाया गया क्योंकि इसकी अधिक छिद्रिल संरचना के कारण आसंजक (एडहेसिव) आसानी से आर-पार हो पाते हैं। उलट इंजिनियरिंग सिद्धांत के अंतर्गत मंमावती रबर डैम के रबर से वस्त्रों को पृथक कर विश्लेषित किया गया एवं पाया गया कि उसी आधार पर वस्त्र निर्मित किए जा सकते हैं। इस प्रक्रिया द्वारा यह सिद्ध हुआ कि नदियों के बड़े बांधों के लिए देशी तरीकों से हेवी-ड्यूटी फैब्रिक जियो-मेम्ब्रन निर्मित किए जा सकते हैं। वस्त्रों को सुदृढ़ बनाने की तकनीकी जानकारीयें प्राप्त हैं एवं जलविभाजकों के लिए आदिप्ररूप (प्रोटोटाईप) बांध के निर्माण में उपयोग हो रहे हैं।

“ठोस अवस्था कीणवन द्वारा एसपरजिलेस निगर स्प. से जायलेन्स के उत्पादन एवं लिग्नोसेल्यूलोजिक पदार्थों में उनके उपयोग” परियोजना के अंतर्गत सूक्ष्म छनन एवं एसीटोन अवक्षेपण विधि द्वारा जायलेन्स का उत्पादन किया गया। परिणाम में यह पाया गया कि कीणवक की सान्द्रता चार गुनी बढ़ी, जबकि विशिष्ट सक्रियता (जायलेन्स सक्रियता/मिली ग्राम प्रोटीन) में 3.3 गुना वृद्धि पायी गयी। अनेक लिग्नोसेल्यूलोजिक पदार्थ जैसे कपास के डंठल, गेहूँ का भूसा, धान का भूसा, बाजरा का भूसा आदि सेल्यूलोज एवं सेल्यूलोज व ए.निगर स्प. जायलेन्स के मिश्रण द्वारा 24 घंटे व 48 घंटों तक जल-अपघटित किये गए अपचायित शर्करा की मात्रा को मापा गया। परिणामों में यह पाया गया

कि ए.निगर स्प. के जायलेन्स लिग्नोसेल्यूलोजिक पदार्थों का निम्निकरण कर सकते हैं।

रंजित वस्त्रों के डी पी परिष्करण के अध्ययन में रंजित एवं उपचारित दोनों वस्त्रों के वस्त्र स्पर्शी माप एवं आरामदेयता गुणों को मापा गया। नीले एवं लाल रंजकों से उपचारित नमूनों में यह पाया गया कि पी.एच. के 3.5 मान पर प्रत्येक वस्त्रों के तीन विभिन्न रंगों (शेड) के उच्चतम कड़ापन (कोशी) मान हैं। साथ ही इन उपचारित वस्त्रों की समतलता (नूमेरी) मान पी.एच. 3.5 की तुलना में पी.एच. 4.5 पर कम हुए। लाल रंजित वस्त्रों में उपचार के पश्चात फुरुकामी (पूर्णा एवं मुलायमता) घट गए, जबकि नीले रंजित वस्त्रों में 3.5 पी.एच. मान पर वृद्धि हुई। नीले एवं लाल रंजित दोनों वस्त्रों की वायु-पारगम्यता गुणों में वृद्धि पायी गयी। दूसरी ओर 3% रंजित वस्त्रों में उपचार के पश्चात नमी - परिवहन गुण में वृद्धि पायी गयी। कन्ट्रोल एवं उपचारित दोनों वस्त्रों के ऊष्मीय - अवरोधन लाल रंजित वस्त्रों में नीले रंजित वस्त्रों की तुलना में अधिक पाए गये। स्थाई दाब परिष्करण के लिए मापक्रम परीक्षण किए गए। प्रिन्टेड एवं रंजित दोनों वस्त्रों को पॉलिकार्बो जैलिक अम्ल तिर्यक - बंधक के रूप में उपयोग कर उपचारित किया गया। डी पी उपचारित वस्त्रों के कलर - स्ट्रेन्थ, स्थाई दाब, ब्रेकिंग - स्ट्रेन्थ एवं आरामदेयता गुण कन्ट्रोल वस्त्रों से उत्तम पाये गए। उपचारित वस्त्रों के वस्त्र स्पर्शी माप से उनमें बेहतर लचीलापन पाया गया। रंजित एवं प्रिन्टेड दोनों वस्त्रों के लिए उपचारित वस्त्रों की समतलता कन्ट्रोल वस्त्रों की तुलना में बेहतर पायी गयी। उपचारित वस्त्रों ने कम लचीलापन (कोशी) एवं कोमलता (फुकुरामी) मान दर्शाये। पृष्ठ की समतलता में उपचार के बाद सुधार पाया गया। उपचार के परिणामस्वरूप वस्त्रों के गुणों में कोई कमी नहीं

पायी गयी ।

“जैविक कपास द्वारा निर्मित एवं काइटोजेन द्वारा परिष्कृत वस्त्रों के पूर्व एवं पश्च पर्यावरण - अनुकूल प्रक्रम” के अध्ययन के अंतर्गत जैविक कपास के बुने एवं निटेड वस्त्र तैयार किये गए और प्रारंभ में बिना किसी उपचार के उनके भौतिक गुणों का मूल्यांकन किया गया । निटेड एवं बुने दोनों वस्त्रों के नमूने पेक्टिनेज के द्वारा अभिमार्जित एवं हाइड्रोजन - पेरोक्साइड के द्वारा विरंजित किये गए । साथ ही वस्त्रों का कियर क्वथन प्रक्रिया द्वारा अभिमार्जित एवं हाइड्रोजन पेरोक्साइड द्वारा विरंजन किया गया । सभी के भौतिक एवं यांत्रिक गुणों का मापन किया गया । जैविक एवं परम्परागत दोनों अभिमार्जित के परिणामों द्वारा वस्त्रों के नमूनों में अवशोषण क्षमता क्षणिक पायी गयी । काइटोजेन उपचार जैव-अभिमार्जित एवं विरंजित बुने हुए वस्त्रों पर किए गए एवं उनकी प्रतिजीवाण्विक सक्रियता भी मापी गयी । जीवाण्विक गणना में 99% की कमी पायी गयी । जब बुने एवं निटेड अभिमार्जित एवं विरंजित वस्त्रों को गुलदाऊदी के फूलों से रंजित किया गया तो इंजाइम विधि द्वारा अभिमार्जित एवं विरंजित वस्त्रों के नमूनों के के/एस मान परम्परागत विधि द्वारा अभिमार्जित एवं विरंजित वस्त्रों से थोड़े अधिक पाए गए ।

“कीटनाशी छिड़काव के दौरान रक्षात्मक वस्त्रों का विकास” परियोजना के अंतर्गत दो मध्यम वजन एवं प्लेन बुनावट वाले 100% सूती भूरे वस्त्रों का 5% पेन्डिमेथालिन घोल के समक्ष कीटनाशी विकर्षण, प्रतिधारण एवं छेदन क्षमता का परीक्षण किया गया । विकर्षण नहीं पाया गया । अवशोषण बढ़ने के कारण शायद विचिक्कणन द्वारा कीटनाशी की छेदन-क्षमता घटी, फिर भी ये स्वीकार करने योग्य रेंज 5-40% से काफी अधिक रहा । पाँच और 100% सूती भूरे वस्त्र

विभिन्न संरचना एवं विभिन्न ग्राम प्रति वर्ग मीटर के खरीदे गए एवं उनकी ए.ए.टी.सी.सी. 135-2004 मानक पद्धति के अनुसार एक से पाँच बार हस्त-धुलाई की गई । धुले हुए वस्त्रों के आर्द्रक समय बूंद-अवशोषण पद्धति द्वारा मापे गए एवं एक बार धुले वस्त्रों के लिए 23 सेकेण्ड से >180 सेकेण्ड एवं पाँच बार धुले वस्त्रों के लिए <1 सेकेण्ड से 35 सेकेण्ड तक पाये गए । सभी धुले वस्त्रों का 5% पेन्डिमेथालिन घोल के समक्ष कीटनाशी छेदन की प्रतिशतता, प्रतिधारण एवं कीटनाशी विकर्षण गुणों को मापने के लिए परीक्षण किये गये । कीटनाशी छेदन की प्रतिशतता एक बार धुले वस्त्रों के लिए 22-24 जबकि पाँच बार धुले वस्त्रों के लिए 17-35 पायी गयी जो मान स्वीकार्य रेंज के अंदर है । उम्मीद के अनुसार सबसे भारी वस्त्रों की कीटनाशी छेदन क्षमता न्यूनतम पायी गयी ।

दो भिन्न प्रारंभिक टायटेनियम आइसोप्रोपोक्साइड एवं टायटेनियम टेट्रा-क्लोराइड व स्टार्च स्थायित्व कारक के रूप में प्रयोग करके टायटेनिया नैनो-कणों का संश्लेषण टायटेनियम डायआक्साइड नैनो-कणों के उत्पादन एवं वस्त्रों के प्रतिजीवाण्विक एवं स्वयं स्वच्छता क्षमता गुणों के अध्ययन के लिए किया गया । टायटेनिया के क्रिस्टल प्राप्त करने के लिए इन सभी पदार्थों को पानी से साफ किया गया एवं 400° सेन्टीग्रेड तापक्रम पर कैलसिन्ड किया गया । इन उत्पादों को एक्स-किरण डिफ्रेक्शन, पराबैंगनी-दृश्य स्पेक्ट्रोफोटोमीटर एवं स्पेक्ट्रो-फ्लोरीमीटर द्वारा अभिलक्षित किया गया । नैनो-टायटेनिया ने अवशोषण स्पेक्ट्रम में ब्लू-शिफ्ट बैंड-गैप में नैनो-स्तर की वृद्धि के कारण दर्शाया । आकार के घटने पर उच्चतम अवशोषण पराबैंगनी-क्षेत्र (ब्लू-शिफ्ट) की ओर स्थानांतरित हो गया । नैनो-टायटेनिया के आकार का

आकलन डी.एल.एस. (डायनामिक लाइट स्कैटरिंग) कण-आकार विश्लेषक द्वारा करने के उपरान्त ट्रान्समीशन इलेक्ट्रॉन माइक्रोस्कोपी द्वारा सुनिश्चित भी किया गया। टी.इ.एम. इमेज में नैनो-टायटेनिया के दो विभिन्न आकार (रॉड एवं गोलाकार) दिखे।

एन.ए.आई.पी. के घटक 4 के अंतर्गत “नैनो-सेल्यूलोज का संश्लेषण एवं अभिलक्षण और इनका जैव अपघटक पॉलीमर कम्पोजिट का निष्पादन बढ़ाने में प्रयोग” नामक परियोजना शुरू हुई जिनके उद्देश्य नवीन माइक्रोबियल, रासायनिक-यांत्रिक प्रक्रिया एवं एंजाइम विधि द्वारा कपास एवं कपास लिंटर से नैनो-सेल्यूलोज (नैनो व्हीस्कर एवं नैनो-फिब्रिल) बनाना, उनके अभिलक्षण तथा साथ ही पॉलिमर नैनो-सेल्यूलोज कम्पोजिट का निर्माण एवं उनके यांत्रिक, बैरियर व जैव अपघटकीय गुणों के मापन एवं मूल्यांकन थे। बंगाल देशी कपास के रेशे से पारंपरिक तनु-अम्ल जल-अपघटन (2.5 एन एच सी एल : 100 सेंटीग्रेड) करके माइक्रो-क्रिस्टलाइन सेल्यूलोज (एम.सी.सी.) तैयार किया। जब एम.सी.सी. की रासायनिक पृष्ठ संरचना को ढीला करने के लिए फेन्टॉन रासायन का प्रयोग किया गया तो एन्जाइम की क्रियाशीलता में कोई वृद्धि नहीं पायी गयी जबकि एम.सी.सी. को फेन्टॉन प्रतिकारक से 10:1:30 के अनुपात में उपचारित किया गया। इसके विपरीत, एन्जाइम क्रियाशीलता में कमी पायी गयी जो एम.सी.सी. की सतह पर लौह तत्वों की उपस्थिति के कारण हो सकती है। एम.सी.सी. का जल अपघटन के लिए ट्राइकोडरमा रीसी कवक का जलमग्न किण्वन अवस्था में प्रयोग किया गया। सेल्यूलोज की क्रियाशीलता एवं कणों के आकार का वितरण दोनों पाँच दिनों तक नोट किए गए। पाया गया कि किण्वन के 24 घंटों के पश्चात नैनो-सेल्यूलोज का

निर्माण हुआ। ऊष्मायन के पाँच दिनों के पश्चात बिलकुल छोटे आकार के कण (< 100 नैनोमीटर) बने। सिर्फ परिष्करण प्रक्रिया के द्वारा रेशकीयन प्राप्त किया जा सकता है। कन्ट्रोल रेशों के औसत आकार 25 माइक्रोमीटर जबकि परिष्कृत रेशे 63 से 642 नैनो मीटर के रेंज में पाये गए। माइक्रो-रेशक का उत्पादन लगभग 44 प्रतिशत लैब-डिस्क रिफाइनर में 30 पासेस के बाद हुआ। स्टार्च का रुपांतरण कार्बोसि-मेथालेशन एवं जिलेटिन द्वारा गिलिसिरोल के साथ किया गया। टेफ्लॉन विलेपित ग्लास प्लेट पर इसे डाला गया एवं निर्वात भट्ठी में फिल्म निर्माण के लिए सुखाया गया। नैनो-सम्मिश्र फिल्म के लिए नैनो-सेल्यूलोज सस्पेंशन को स्टार्च के गाढ़े घोल के साथ मिलाया गया और फिल्म का निर्माण हुआ। नैनो फिल्म के निर्माण के लिए दो विभिन्न प्रक्रियाओं द्वारा प्रयास किए गए। कन्ट्रोल एवं नैनो कम्पोजिट दोनों वस्त्रों के यांत्रिक गुण यथा, तन्यता शक्ति एवं टूटने के वक्त का खिंचाव का विश्लेषण किया गया। कन्ट्रोल फिल्म के लिए तन्यता शक्ति 99 एम.पीए. एवं टूटने के वक्त खिंचाव 24% एवं नैनो-कम्पोजिट फिल्म के लिए तन्यता शक्ति 103 एम.पीए. एवं टूटने के वक्त खिंचाव 26% पाये गए।

बीटी कपास के बिनौलों में प्रोटीन एवं तेल की मात्रा का निर्धारण एवं अभिलक्षण करने हेतु एफ 1 एवं एफ 2 वंश के साथ बीटी कपास के नमूने प्राप्त किए गए एवं बिनौले में तेल की मात्रा के लिए मूल्यांकन किया गया। अठारह नमूनों का वसीय अम्ल प्रोफाइल एवं तेल की मात्रा के लिए मूल्यांकन किया गया। परीक्षण के परिणामों में पाया गया कि जे.के.सीडस एवं कम्पनी के एफ 2 वंश के बीजों में तेल की मात्रा में कमी, जबकि कॉटन रिसर्च स्टेशन (सूरत) एवं कृषि विज्ञान विश्वविद्यालय धारवाड़ के बीजों के नमूनों में विपरीत

प्रवृत्ति पायी गयी। इन स्थानों से प्राप्त बीजों के नमूनों में एफ 2 वंश के बीजों में एफ 1 बीजों की तुलना में अधिक तेल की मात्रा पायी गयी। इसके पश्चात, यह भी ध्यान देने योग्य है कि नवसारी कृषि विश्वविद्यालय एवं कृषि विज्ञान विश्वविद्यालय, धारवाड़ से प्राप्त बीटी कपास के बीजों में तेल की मात्रा लगातार अच्छी पायी गयी। एफ 1 एवं एफ 2 बीजों के तेलों में प्रोटीन की मात्रा में कोई खास या महत्वपूर्ण बदलाव नहीं पाया गया, सिर्फ एफ 2 के कुछ नमूनों को छोड़कर जिनमें प्रोटीन की मात्रा में कुछ कमी हुई। साधारणतया जे.के.सीड्स एवं कॉटन रिसर्च स्टेशन (सूरत) के नमूनों में प्रोटीन की मात्रा थोड़ी कम पायी गयी। बीटी कपास के बीजों के नमूनों के लिए उनके वंश एवं उनके तेलों में प्रोटीन की मात्रा का प्रोफाइल तैयार किया जा रहा है।

बन्नी बीटी कपास के बीज प्राप्त करके उनका उत्सारण कुकिंग विधि द्वारा कॉटन सीड मील में मूल्य संवर्धित उत्पाद तैयार करते हेतु वितंतुकीरण एवं आवरण उतारा गया। कॉटन सीड मील को लेकर छाना गया व दो भागों में बांटा गया। पूर्ण कपास के बीज से एक्पेलर द्वारा तेल निष्कर्षित किया गया व खल्ली तैयार हुई। खल्ली के इन नमूनों का चूर्ण बनाया गया एवं कसावा आँटे के साथ 20 : 80, 30 : 70 एवं 40 : 60 के अनुपातों में मिश्रित किया गया। नमी की मात्रा 16% तक नियत रखने हेतु जल मिश्रित किया गया। इन नमूनों को उत्सारण कूकर में डाला गया। कूकर का तापक्रम 85° सेन्टीग्रेड एवं डाई का तापक्रम 150 से 1800° सेन्टीग्रेड तक बदला गया। 40% से कम कपास के बीज होने पर पर्फिंग देखा गया एवं कलर ग्रेड भी उत्तम पाया गया। कलर ग्रेड व उत्तम पर्फिंग के लिए कपास बीज के मील एवं कसावा आँटे का अनुपात 20:80 एवं 30:70 उपयुक्त पाया गया।

“मूल्य संवर्धित उत्पादों के लिए कपास के उपोत्पादों का प्रयोग” नामक परियोजना के अंतर्गत नांदेड़ के (प्राइवेट) निजी संस्थान की पहचान कर उनके द्वारा कपास डंठलों को इकट्ठा करके तराशने एवं उनकी दुलाई का काम कराया गया। एक नया ट्रैक्टर एवं तराशने की नई मशीन खरीदकर नांदेड़ के पास लगायी गयी एवं कपास के डंठलों की आपूर्ति बढ़ाने के लिए किसानों को उत्साहित किया गया। कपास के डंठलों को तराशकर मेसर्स गोदावरी पार्टिकल बोर्ड इंडस्ट्री में बोर्ड बनाने हेतु भेजा गया। पन्द्रह सौ रुपये प्रति टन की दर से लगभग 500 टन चिप्स (तराशे हुए कपास के डंठल) की आपूर्ति की गयी। कोयंबतूर एवं नागपुर के समीप किसानों को कपास के डंठलों का कच्चे माल के रूप में उपयोग कर अतिरिक्त आय-श्रोत बनाने हेतु जागरुकता बैठकें आयोजित की गईं। कपास के क्षेत्र में उपलब्ध फसलों के अवशिष्टों का बेहतर उपयोग करने हेतु शहतूत के डंठल एवं बगास मिश्रित कर परीक्षण किए गए। परिणामों ने दर्शाया कि इनसे उत्तम गुणवत्ता वाले बोर्ड तैयार किए जा सकते हैं।

प्रौद्योगिकी कपास मिशन एम.एम. 1 की “कपास उपोत्पादों के मूल्य संवर्धन व व्यावसायिक तकनीकी विकास एवं सुधार” नामक परियोजना के अंतर्गत कपास के बीजों के भंडारण के वक्त कवकी (फन्नाल) विस्तार एफ्लोटोक्सीन की रोकथाम के लिए परीक्षण किए गए एवं पाया गया कि 1% प्रोपायोनिक अम्ल का बीजों पर छिड़काव करने से लगभग छः महीने तक कवकी विस्तार की रोकथाम की जा सकती है। एक सौ किलोग्राम बीजों से शुरुआत करके एक टन बीजों पर परीक्षण किए गए और बीजों के नमूनों को हर माह बाहर निकालकर उनमें उपस्थित कवकी की संख्या जाँची गयी और उनमें कमी भी पायी गयी। साथ ही, सब्जियों

के अपशिष्टों पर छिड़काव हेतु माइक्रोबियल कन्सोर्टियम का निर्माण प्रोपायोनिक अम्ल के साथ अन्य एन्जाइम यथा पेक्टिनेज आदि के निर्माण हेतु परीक्षण भी जारी हैं।

राष्ट्रीय कृषि नवोन्मेषि परियोजना के अंतर्गत भारतीय कृषि अनुसंधान परिषद ने सिरकॉट, मुंबई में क्षेत्रीय प्रौद्योगिकी प्रबंधन एवं व्यवसाय योजना एवं विकास केन्द्रों की स्थापना की। प्रारंभ में जेड टी एम-बी पी डी सिरकॉट आइ सी ए आर के पश्चिमी क्षेत्र के संस्थानों एवं सिरकॉट के विकसित तकनीकों पर ध्यान रखेगी। भविष्य में जेड टी एम-बी पी डी सिरकॉट नये उद्योगों के नई-नई विकास योजना में मदद करेगी।

विस्तार कार्यकलाप

संस्थान, सिरकॉट के निदेशक एवं वैज्ञानिक कपास परीक्षण एवं कपास के मानक बी.आई.एस. जैसे संस्थाओं में समितियों के सदस्य बने रहे साथ ही ATIRA, BTRA, SITRA, UICT आदि संस्थानों के विभिन्न पैनलों में भी सम्मिलित हुए। इस वर्ष के दौरान संस्थान में विस्तार कार्यकलापों के विवरण इस प्रकार हैं - (i) कपास के रेशों, धागों व वस्त्रों की गुणवत्ता मूल्यांकन की सटीक एवं विश्वसनीय डाटा की आपूर्ति (ii) परामर्श सेवाएं, (iii) शोध परिणामों की वैज्ञानिक

पत्रों, परिचायिकाओं एवं पुस्तकों आदि के रूप में प्रकाशन, जिससे संबंधित लोग इससे लाभान्वित हो सकें एवं (iv) प्रशिक्षण कार्यक्रमों द्वारा तकनीकी सूचना का विस्तार।

वर्ष के दौरान संस्थान के परीक्षण हाउस में 6084 कपास के नमूने रेशे, सूत एवं वस्त्र परीक्षण के लिए त प्राप्त हुए एवं 3000 नमूने क्षेत्रीय केन्द्रों पर प्राप्त किए गए। सिरकॉट मुख्यालय में कपास की गुणवत्ता मूल्यांकन विषयों पर प्रशिक्षण कार्यक्रम आयोजित किए गए, जिनमें वस्त्र-उद्योग जगत के लगभग 74 प्रशिक्षणार्थियों ने भाग लिया। इन प्रशिक्षण कोर्स में एच.वी.आई. एवं ए.एफ.आई.एस. संयंत्रों की विस्तृत जानकारी व ट्रेनिंग कपास एवं वस्त्र-उद्योग से संबंधित लोगों को विशेष रूप से दी गई। जी.टी.सी. नागपुर में लगभग 199 प्रायोजित लोगों को ओटाई के विभिन्न पहलुओं पर प्रशिक्षण दिया गया। संस्थान में विकसित तकनीकों को लोकप्रिय बनाने के लिए सिरकॉट ने कई प्रदर्शनियों में भाग लेकर सिरकॉट के तकनीकों को प्रदर्शित किया। सिरकॉट ने संसाधन-उत्पात्ति के रूप में वर्ष 2008-2009 के दौरान व्यावसायिक नमूनों के परीक्षण, परामर्श सेवाएं, प्रशिक्षण एवं रिवोल्विंग फंड कार्यक्रमों द्वारा 65.71 लाख रुपये अर्जित किए।

1

Introduction

This Eighty-fifth Annual Report of the Central Institute for Research on Cotton Technology (CIRCOT) covers the period from April 1, 2008 to March 31, 2009.

CIRCOT was established in the year 1924 by the then **Indian Central Cotton Committee (ICCC)** under the name of **Technological Laboratory of ICCC**. At that juncture the objectives were to undertake spinning tests on various cotton strains received from agricultural departments in the country and to assess their spinning value. These activities were carried out by the Institute in close co-ordination with the Departments of Agriculture and Agricultural Universities located in major cotton producing tracts in the country. After the abolition of commodity committees including the ICCC, the administrative control was transferred to the Indian Council of Agricultural Research (ICAR) and the name of the Institute was changed to **Cotton Technological Research Laboratory (CTRL)**. Since then the research activities have been reoriented and strengthened towards increasing the production and quality of cotton in the country. Research on better utilisation of cotton and cotton agro-wastes was

recently accorded higher priority with a view to provide avenues for additional income to the grower and to promote self-employment opportunities for rural people.

Realising the phenomenal increase in the research component, the Quinquennial Review Team (QRT) recommended changing the name of CTRL to **Central Institute for Research on Cotton Technology (CIRCOT)** with effect from April 1, 1991.

Mandate

- To develop new technologies and machinery for better utilization of cotton and other textile fibres by carrying out basic, applied, strategic and anticipatory research in post harvest technology.
- To extend effective technological support for improvement of quality of Indian cottons and cotton products.
- To act as nodal centre for diversified utilisation of cotton plant by-products & processing waste and other crop residues.

- To provide services like training, education and consultancy to textile industry, Government and private agencies and to function as a referral laboratory for textile testing.

Achievements Made in the Recent Past

- In collaboration with VNIT (Visvesvaraya National Institute of Technology), Nagpur, the Institute has designed and developed a Laboratory Model Double Roller Gin. The salient features of this new gin, christened as Hipro D. R. Gin are that the capacity of this gin is 50 – 55 kg cotton per hour, works on single-phase electric supply and that the power requirement for this machine is 3 hp single-phase or 2 hp three-phase electric motor. This machine is suitable for use by cotton breeders, traders and also by farmers for their own sowing needs.
- In a project for assessing the processing cost in a modernised ginning factory, data on staff salary, expenditure on repair and maintenance, office expenditure, bagging and tie and electricity were collected for three different zones. The survey finding indicates that in the modernised ginning industries payment towards electricity was the single largest expenditure in any zone.
- In an evaluation on the different

types of seed cotton feeding systems used in a modern ginning industry, it was found that none of the feeding system was able to feed the gin without interruption with the required quantity of seed cotton. There was also no significant difference in the lint outturn of all component gins for a trolley system feeding 6 jumbo DR gins. Beyond this limit the output of the gin was affected when fed by a trolley system.

- In the case of mechanically picked cotton, when it was processed through cylinder cleaner → stick machine → saw cylinder cleaner → double roller gin → post cleaner the overall quality and lint grade improved.
- The roller-grooving machine currently designed and fabricated by CIRCOT was noted to minimize the time required for grooving and reduce the machine downtime. With the help of this machine grooves can be cut easily and labour involvement could be minimum.
- A detailed manual on do's and don'ts especially on trouble shooting and its redressal on the various problems faced by the ginners regarding ginning and maintenance of various machinery on a day-to-day basis has been prepared after a detailed on-the-spot study of several modernized

INTRODUCTION

ginneries in Maharashtra. The problems that crop at various stages were identified and analysed and remedial measures have been suggested. This manual is the first of its kind written keeping in view the problems faced by the field staff in the ginnery.

- In a study carried out to find out the processing loss of cotton in a modernized ginnery, it was noted that the processing loss varied with cotton ginned, condition of the cotton, the amount and nature of trash in the cotton, time of harvest, moisture content at the time of processing and types and condition of machinery used. The study provided a general understanding about the level of processing loss and also guidelines for the ginners to know the expected processing loss in their modernized ginneries and means to reduce the same.
- Effect of different automation systems on fibre quality in modernized ginneries indicated that no significant difference at 5% level was observed with the type of automation for 2.5% span length, uniformity ratio, fineness and short fibre content when tested by using the HVI. AFIS analysis of samples has shown significant difference for short fiber content although there was no significant difference in the IFC and Neps content.
- Under a collaborative project with M/s. Cottor Plants India Ltd., Mumbai, a prototype Variable Speed Saw Gin has been designed and fabricated. All the accessories required for the gin stand are also fabricated and installed along with the saw gin.
- In a collaborative project between CIRCOT and M/s. Millenium Rubber Technologies, Kerala a rubber and fabric based roller for double roller gin has been fabricated. The soft rubber layer of the self grooving rubber roller was modified so that it abraded faster and in the process a better groove was formed. The hardness and abrasive resistance of the roller were increased to enhance the life of the roller. The newly designed roller could circumvent the problem posed by the chromium contamination in lint.
- An user software based database has been created with which it is possible to keep track on various details like infrastructure, kapas, bale, seed, ginning, maintenance of various machinery, details about workers, financial and transaction account. Reports can be generated for any query from the database.
- Under the All India Coordinated Cotton Improvement Project (AICCIP), 6687 samples have been tested at the headquarters and various regional quality evaluation units for different fibre quality parameters. A large number of

samples received from various agricultural trials were also evaluated for fibre quality.

- During 2007-08, 92 trade and 54 standard cotton varieties were received from different locations and analysis of fibre properties completed.
- CIRCOT has developed a low cost sliver making machine named CIRCOT Mini Card suitable for producing sliver of about 1.8 kg/h. M/s. Varhad Seva Pratishtan, an NGO based in Akola has been making use of this machine for processing of cotton into slivers and further the sliver into yarn by a conventional method followed in the village. They have reported that the yarns produced from the sliver prepared by the Mini Card were better in quality than the one produced from sliver made by conventional method.
- CIRCOT has demonstrated the feasibility of blending cotton with ramie for producing woven fabrics. One hundred kg of decorticated ramie fibres received from CRIJAF, Barrackpore were subjected to biochemical degumming. The degummed and bleached fibres were sent to SITRA, Coimbatore for blending with cotton and also for yarn making and weaving. The fibres were stapled, blended with Shankar 6 cotton and spun. Blending trials indicated that 30% ramie with 70% cotton resulted in better yarn properties. Woven fabrics were converted into garments in addition to preparation of towels, table spreads, etc.
- In a study on the physico-chemical and structural characteristics of banana pseudostem fibre, it was found that the fibres exhibited a wide range of strength values from 60.8 g/tex to 3.2g/tex. The breaking strain values ranged from 1.7% to 3.7%. The tex value of the thicker fibres is seen to be almost double than that of the thinner fibres within a variety. A small modification has been made in Raspador fibre extractor to suit the extraction of fibres from banana pseudostem. Also, a cleaner has been developed to remove non-fibrous material from the extracted fibres. These two in combination give fibres, which are as good as hand-extracted material in terms of mechanical properties. However, hand extracted fibres possessed better whiteness index, soft silky feel with silvery appearance.
- Studies on the wear comfort of knitted fabrics showed that the air-permeability of fabrics with different loop lengths was found to rise with increasing loop length as well as in porosity.
- A statistical analysis of the fibre

INTRODUCTION

property profile of *G. arboreum* strain from the north zone spread over a period of 35 years from 1970 to 2005 was made in an effort to assess the performance of this cotton over a period of time from the release. The thirty-five year's period was divided into seven blocks of five years each and the performance was thus assessed for every five years since release. Three types of analysis were performed viz. performance of each block with that of the base-level block 1970-74, evaluating the performance of the test strains with respect to the check for each block and the performance of the test strains evaluated with reference to the check variety within each block. The results indicated that:

- The quality improvement over the successive blocks did not show any consistent pattern and was always less than the base-level block (1970-74), only the last block 2000-04 had comparable performance as 1970-74 block.
- Except the 1st block, in all the succeeding blocks, the test strains on an average, performed better than the check.
- The performance of strains effectively improved from 1990 onwards only and before this period, the performance of

strains was not satisfactory.

- For assessing the competitiveness of cotton Yarn Produced in India in the Global Textile Trade, the Nominal Protection Coefficient (NPC) was calculated taking the price of export quality cotton yarn produced in India and the unit value realization from the export of the cotton yarn to different countries. Though the NPC values are higher than those calculated using the price of domestic yarn but they are still less than 1 showing the comparative advantage that is enjoyed by the spinning industry in India. Analysis of the variation in the selling price and raw material cost of the domestic as well as export quality yarn showed that the variations between the selling price of the export quality yarn and the domestic yarn were persisting mainly for higher counts and they remain close to one another for the lower count group yarn. Similar trend prevails for the raw material cost of the cotton used for export quality yarn and the domestic yarn. Domestic Resource Cost ratio for cotton yarn computed by using the cost of production of the export quality yarn was less than one showing the foreign exchange earning capacity of

the sector. The cost of production of export quality yarn witnessed a drop in recent years due to significant reduction in the cost of the raw material, thereby improving the DRC ratio for the Cotton yarn.

- The conventional two stage processing viz. scouring followed by bleaching is a time and energy consuming process. To derive economic advantage, a new process was developed where both scouring and bleaching is carried out simultaneously in a single bath within a duration of 1 hr at the temperature of boiling water. This process has been tried out while preparing absorbent cotton upto 3 kg batch. A patent has been filed and granted for the single stage process.
- A large scale trial of enzymatic bioscouring of cotton fabrics with pectinase enzyme was made for the preparation of terry towel using yarn prepared from organic cotton procured from a private company. Yarn preparation and bioscouring treatments were also carried out in a private mill premises. Same conditions were used both in the laboratory as well as in the mill premises. Terry towels prepared using this method had comparable water holding capacity as that of those prepared by chemical scouring method. The advantage of this process lies in its "green" technology.
- Attempts have been made to evaluate the effect of various sugars, sodium salts and nitrogen sources on the production of xylanase by *Aspergillus niger* by solid state fermentation process. Among the sodium salts, sodium chloride was found to increase the xylanase production significantly. Among the nitrogen sources, sodium nitrate produced 30% more xylanase. The xylanase activity of the enzyme produced on sodium nitrate was 36.9 mg/g of wheat bran. Preliminary results indicated that it is possible to reduce the use of bleaching liquor if bagasse pulp is subjected to pretreatment with xylanase produced by solid state fermentation as described above.
- In a project on the preparation of zinc oxide nanoparticles from zinc nitrate and sodium hydroxide as precursors with soluble starch stabilizer, about 100 g of ZnO nanoparticles have been synthesised. Purification was done by repeated washing and centrifugation and characterised by using UV visible spectrum. Nanoparticles prepared were in the size of 30 to 40 nm. It was demonstrated that zinc oxide nanoparticle finished cotton fabrics exhibited good antibacterial activity. The technology of synthesis of ZnO nanomaterials has been transferred

INTRODUCTION

to M/s. ANABOND Ltd., Chennai.

- Trials were conducted for coating paper with Zinc Oxide at CPPRI, Saharanpur and at PAPRI, Orissa both in bulk and in the nano form to find out the suitability of each of the treatment for antifungal property, brightness, whiteness and print density. It was found that nano zinc oxide coated paper has superior properties compared to ordinary zinc oxide in respect of brightness, whiteness, paper smoothness, print density & uniformity, picking velocity and oil absorbency.
- Around 9946 commercial samples of fibre, yarn and fabric were tested as part of the commercial service at the Headquarters and at the Regional units during the year 2008-2009.
- The Institute conducts regular training courses on Cotton Quality Evaluation as well as specialized courses in the operation of High Volume Instrument (HVI) and Advanced Fibre Information System (AFIS) and interpretation of test results obtained from these state-of-the-art facilities at the Headquarters for the sponsored personnel from the cotton trade and industry. At the Ginning Training Centre of CIRCOT at Nagpur both theoretical and practical training skills are imparted on different aspects of ginning and maintenance

of ginning machines. During 2008-2009, 74 sponsored personnel underwent different types of training in six batches at the headquarters while 119 personnel were trained in eight batches at the Ginning Training Centre at Nagpur.

Patents Applied during the Current Year

- Microbiological pretreatment of polyester fabric to improve the moisture regain and wear comfort
- Biological softening of lignocellulosic material for preparing binderless board
- Microbial degumming of mulberry silk
- Roller type cotton stalk compacting machine
- Miniature lap preparation machine for microspinning
- A parallelised yarn bundle preparation machine for yarn strength test
- A new enzymatic process for the preparation of absorbent cotton from non-spinnable short staple cotton
- Process for dyeing textiles using solvent extracted marigold flower waste
- A biochemical process for preparation of absorbent cotton from non-spinnable cottons using

microbial consortium

- A bioenrichment of cattle feed for better digestability
- A method for production of cellulose powder from crop residues
- Degumming of decorticated ramie fibres by a biochemical method.

MoUs signed by Director, CIRCOT in the recent past

- M/s. Precision Tooling Engineers, Nagpur for manufacturing and marketing of Lilliput Gin for ginning small seed cotton samples.
- M/s. Trytex Machine Co., Coimbatore for manufacture of a Miniature Spinning System, the know-how for which was supplied by CIRCOT.
- M/s. Punjab Durrie Weavers, Chandigarh for working on the development and use of natural dyes in textiles.
- M/s. Precision Tooling Engineers, Nagpur for Hydraulic Cotton Plant

Stalk Compacting Machine

- M/s. Precision Tooling Engineers, Nagpur for commercial manufacture of HIPRO DR Gins.
- Government of Meghalaya, Shillong for Biological Degumming of Decorticated Ramie Fibres
- M/s. Renaissance Paper Mill Ltd., Nagaland for preparation of paper from bamboo and other biomass grown in the northeastern region of India

Revenue Generation :

The Institute generated Rs. 58.66 lakhs through commercial testing, training and consultancy during the current year.

Organisation : The Institute is headed by Director assisted by a team of scientists and technical Officers. An Administrative Officer and Finance and Accounts Officer assists him in matters of general administration and those connected with accounts and audit of the Institute respectively.

ORGANISATIONAL CHART

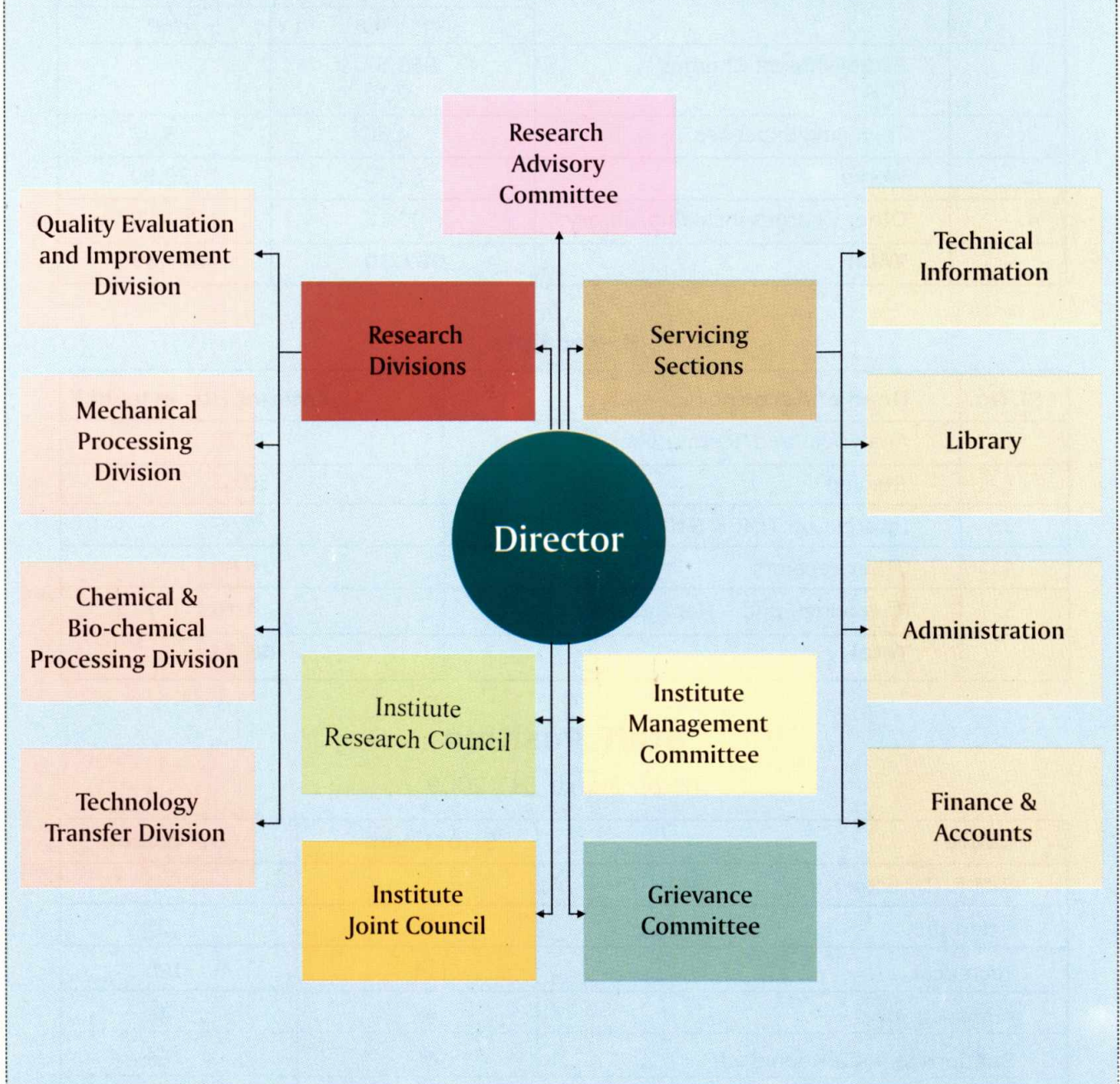

Financial Statement

Expenditure and Receipts of the Institute during 2008-2009

A. Expenditure

Sl. No.	Head of Account	Expenditure (Rs. in lakhs)	
		Non-Plan	Plan
1.	Establishment Charges OTA	858.57 0.15	- -
2.	Travelling Expenses	4.50	8.00
3.	Works	33.90	120.00
4.	Other Charges including Library	90.18	341.89
	Total	987.30	469.89

B. Receipts

Sl. No.	Head of Account	Amount (Rs. in lakhs)
1.	Analytical and Testing Fees	20.38
2.	Training	10.65
3.	Interest on TDR & STD	9.57
4.	Other receipts	20.96
5.	Revolving Fund – Net Receipts	4.15
	Total	65.71

Staff Position

As on March 31, 2009

Cadre	Sanctioned	In Position
R.M.P. (Director)	1	1
Scientific	50	27
Technical	114	100
Administrative	48	46
Supporting + Canteen Staff	66	56
Total	279	230

2

Research Achievements

A brief account of the Progress made in various research projects carried out during 2008–2009 both at the headquarters and at its various regional stations including the Ginning Training Centre, Nagpur is given below:

CORE AREA I : IMPROVEMENT IN GINNING OF COTTON

The Performance Evaluation of Cyclones used in Modern Ginneries

Cyclone separators are most popular and common device used in industries for cleaning of gas, for the low initial investment involved, low operation and maintenance cost, absence of any moving part, flexibility in extreme operating conditions, requirement of less space for operation and high reliability. The basic principle of cyclone separator is forcing trash laden gas into a cylindrical vortex where inertia and gravitation forces cause separation of trash particles from the main stream. The cyclone separator consists of a barrel, a conical component and a vortex finder tube for the escape of the gaseous material.

An experimental setup for an improved cyclone separator suitable for use in ginneries has been designed and

developed at GTC, Nagpur (Fig. 1 and 2). It consists of two cyclones (1D3D and 2D2D) of 300 mm diameter each, dust regulator, dust feeder, piping system and dust collector. Numerical modeling of continuous phase of 1D3D and 2D2D cyclones of 300 mm diameter each has been carried out. The models have been implemented in the general purpose unstructured finite volume code Fluent V6.2.

Gambit V2.2.30 environment was used as a preprocessing tool for generation of grid. The entire cyclone was divided in several blocks to mesh it properly and each block was meshed separately. Non-conformal mesh interfacing was implemented between tangential inlet portion and main body of cyclone to avoid skewness of cells. Cooper meshing facility was used to generate purely hexahedral/quadrilateral mesh for each block of cyclone. There were 63416 and 55319 hexahedral control volume cells for 1D3D and 2D2D cyclones, respectively.

The pressure drop in a cyclone was determined as difference in area weighted average of static pressure at cyclone inlet and overflow. The pressure drops in 1D3D and 2D2D cyclones were

found as 2000 Pa and 2078 Pa, respectively. The typical Rankine type vortex is found in case of tangential velocity and axial velocity is found directed downward near wall and upward in region near axis. The radial velocity is the smallest and directed inward almost everywhere.

The measured velocity profiles show that the central core region in the cyclone rotates like a solid body where the tangential velocity is increasing with an increasing radius. The maximum tangential velocity of approximately 2.0 times the inlet velocity is reached at a

radius of 30% from the centre of cyclone. Then, it starts decreasing and reaches zero at the wall.

The axial velocity profiles show a typical W structure, which is zero both at wall and at centre. The positive velocities are directed upward towards the outlet. There is an outer region close to the wall where the flow is directed downwards. The maximum velocity is found near the centre of cyclone. The radial velocity is also directed towards the centre of cyclones. It increases almost linearly from zero at the wall to the maximum at centre.

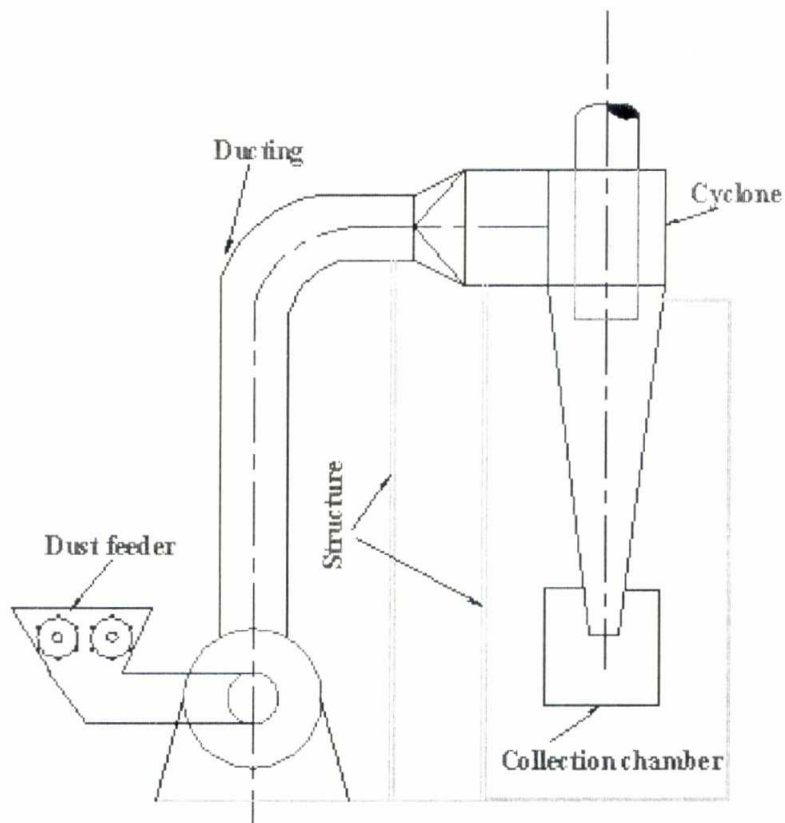

Fig. 1 : Experimental Setup of Cyclone Separator



Fig.2 : A Fabricated System of Cyclones at GTC, Nagpur

Design and Development of Barcode Technology for Tagging Cotton Bales

A computerised software namely **Cotton Bale Manager** has been developed to perform two important functions viz. 1) Design and generation of bale identification tag and 2) Computer interfacing of bale tags and management of bale database including the information about bale ID and its fibre quality parameters.

This software has been designed to generate an unique bar-coded customized label for every individual bale and is integrated with bale information

along with its fibre properties. The user can generate a sequence of customized labels with 16-bit bar-coded permanent bale ID (Fig. 3). Each bale label includes information on the factory name, the press mark number, year of production, bar-coded bale ID and bar code. Also the user can edit, save, and print the specific labels along with search facility to access information on designed labels. The software can read the bale bar-coded ID with the help of a barcode scanner. **Cotton Bale Manager** also includes an integrated database which is developed using VB programming language in a Microsoft Data Access. This database is interfaced with the bale

bar-coded ID's. The designed software will open the record for the bale if information has been already entered for that ID or the user can also enter records for new bale IDs. User can also browse and search the database using different criteria. Any user can search and query the database and generate report.

The software has been successfully tested to generate labels for the bales prepared under the NAIP cotton value chain project. Plastic stickers are used to prepare the bar-coded labels and are printed on the bar-code printer. The size of the label is kept as 100 x 75 mm. The bale database including its bale marking parameters and fibre quality parameters have been integrated with bale ID's.

GIMA Manufacturing Pvt Ltd.
Hinganghat



MS66720080005001

Press Mark No: MS667

Year of Production: 2008

Lot No: 0005

Fig. 3 : A Typical Barcode Label

Design and Development of an Axial Flow Cotton Pre-cleaner

A Cotton pre-cleaner based on axial flow principle has been designed and fabricated. The 3D drawings and 2D drafting's of the machine components,

subassemblies and whole machine were prepared in CATIYA software. Based on the design parameters, a single cylinder axial flow pre-cleaner has been fabricated. The single cylinder pre-cleaner of 1200 mm cylinder length and overall peripheral cylinder diameter of 443.4 mm has a capacity to clean 7-10 quintals of seed cotton per hour. The fabricated three cylinder system consists of assemblies of cylinder diameters of 203.2, 250.4 and 304.8 mm with spike lengths of 114.6, 89.2 and 63.8 mm respectively and an adjustable semicircular grid with radius of 242 mm having grid bars of 10 mm diameter spaced at 10 and 12 mm for each half length of the cylinder. The top cover assembly has a radius of 350 mm and is provided with suitable inlets and outlets. The guide plates are designed to be mounted on the inside surface of the top cover to guide the movement of the seed cotton along the axis of the cylinder. The feeder assembly is also fabricated for controlled feeding of the seed cotton to the pre-cleaner. The feeder length is kept as 300 mm. The mainframe of the machine is made of ISMC 100 x 50 channels. The drive to the cylinder is provided with 2 Hp motor and geared motor of 0.5 Hp is also made available for the feeder. The machine speed could be varied between 225 to 400 rpm with the help of a variable frequency drive. The preliminary testing of the machine has been satisfactory confirming that the principle of axial flow could be effectively used for pre-cleaning of seed cotton.



Fig. 4. Fabricated set-up of an Axial Flow Cotton Precleaner

CORE AREA II : IMPROVEMENT AND QUALITY EVALUATION OF FIBRE, YARN AND FABRIC

This core area encompasses three distinct facets of technological research:

- a) Evaluation of the quality of cotton samples received from agricultural trials and the All India Co-ordinated Cotton Improvement Project (AICCIP).
- b) Tests on Standard and Trade varieties of Indian cotton.
- c) Research work done on specific agricultural and technological aspects relevant to improvement of cotton attributes.

a) Evaluation of the Quality of Cotton Samples under the All India Co-ordinated Cotton Improvement Project

The All India Co-ordinated Cotton Improvement Project (AICCIP) was launched in April 1967 with a view to improve cotton productivity and quality through coordination of research efforts at various Institutes, Agricultural Universities, State Departments of Agriculture and other related agencies. CIRCOT is primarily involved in research pertaining to quality evaluation of cotton lint, its mechanical behaviour at various stages of processing upto spinning of yarn and evaluation of its characteristics.

The regional stations of CIRCOT in the cotton growing areas participate in quality evaluation of cotton strains developed and tested under the AICCIP. The initial breeding material, is tested for quality parameters at the regional units of CIRCOT, while most of the strains under National Trials are tested at regional unit Nagpur. Advanced trials are subjected to microspinning, full spinning and mill processing at Headquarters, Mumbai. For the last five years fibre samples pertaining to ICAR Bt cotton trials conducted under AICCIP are also tested at Headquarters, Mumbai. Further, monitoring of various quality parameters, collection of data and finalization of reports are exclusively carried out at CIRCOT Headquarters, Mumbai.

Breeding materials, Initial Evaluation Trials (IET) and Preliminary Varietal Trials (PVT) constitute the initial stages of cotton breeding programme under the AICCIP. Promising strains amongst these trials are drafted under Coordinated Varietal Trial (CVT) called Advanced Trials. The samples under IET or PVT are tested only for fibre quality parameters using the High Volume Instrument (HVI) whereas samples of CVT are evaluated for spinning tests besides fibre parameters. Finally, before releasing the cotton variety/hybrid for commercial cultivation, its full spinning potential is checked. This is to ensure its acceptance by textile industry once released and cultivated on a large scale in farmer's field.

Cotton cultivation in India is carried out under three prominent zones. These are as follows :

Zone	States
North	Punjab, Haryana, Rajasthan, Uttar Pradesh and New Delhi
Central	Madhya Pradesh, Maharashtra, Gujarat and Orissa
South	Andhra Pradesh, Karnataka and Tamil Nadu

A large number of cotton samples are received every year for quality evaluation from trials conducted under AICCIP by Agricultural Universities and private participants. The number of samples received during 2008-09 season for different tests from agricultural trials at the Headquarters, Mumbai is given in Table 1 and those tested at each of the regional units of CIRCOT are presented in Table 2. The number of cotton samples received from different states and tested at CIRCOT under AICCIP for various quality parameters is given in Table 3.

The following abstracts related to forty-second Annual Report, summaries the test results of 6721 cotton samples and their spinning potential including yarn quality analysis for 2007-2008 cotton season.

RESEARCH ACHIEVEMENTS

TABLE 1 : NUMBER OF COTTON SAMPLES RECEIVED AT CIRCOT HEADQUARTERS FROM AGRICULTURAL TRIALS DURING X AND XI PLAN

Types of Tests	Average for the last five years (2003-04 to 2007-08)	2008-09
Fibre and full spinning	59	6
Fibre and Microspinning	442	68
Fibre Test alone	3323	2132
Mill Test	8	1
Standard Cottons	47	57
Trade Varieties	42	92
Germplasm	913	458
Research	61	206
Consultancy project	-	114
Total	4895	3136

TABLE 2 : NUMBER OF COTTON SAMPLES TESTED AT THE REGIONAL QUALITY EVALUATION UNITS DURING 2008-2009

Regional Units	No. of Sample Tested
Nagpur	7005
Surat	10742
Sirsa	4187
Dharwad	1563
Coimbatore	5640
Guntur	9011

TABLE 3 : STATE-WISE NUMBER OF COTTON SAMPLES TESTED AT CIRCOT UNDER AICCIP DURING 2008-2009

State	Fibre and full spinning	Fibre and microspinning	HVI alone	Total
Punjab	-	5(1)	604 (30)	609 (31)
Haryana	-	-	415 (22)	415 (22)
Rajasthan	-	-	440 (23)	440 (23)
Uttar Pradesh	-	-	150 (8)	150 (8)
Gujarat	3(1)	-	685 (39)	688 (40)
Maharashtra	1(1)	11(1)	1287 (66)	1299 (68)
Madhya Pradesh	-	29 (3)	631 (33)	660 (36)
Orissa	-	-	151 (6)	151 (6)
Karnataka	1(1)	44 (4)	898 (42)	943 (47)
Andhra Pradesh	-	-	411 (17)	411 (17)
Tamil Nadu	2 (1)	-	919 (39)	921 (40)
Total	7 (4)	89 (9)	6591 (325)	6687 (338)

Note : The numbers in bracket shows the number of reports issued.

NORTH ZONE

1. *G.hirsutum* Trials

Preliminary Varietal Trial (PVT) Br.03 : The trials were conducted at seven locations. In general 2.5% span length was found to be around 25.5 mm and noted to be the same at all locations. The strains yielded very coarse fibres (Micronaire 4.7) at most of the locations except at Kanpur and Sriganaganagar where it was comparatively finer (Micronaire 4.1). The strength values were also around 21.5 g/t but it was marginally on the higher side (22.6 g/t) at Abohar and lower (20.4 g/t) at Ludhiana. On the basis of fibre quality norms the strains H.1300, Bihani 161, RS.2455, CSH.3114, H.1278, LH.2111 were noted to be promising with Bihani 161 possessing good quality at four locations.

Intra-hirsutum Hybrid Trial Br.05 : These trials were conducted at six locations. In general, the values of 2.5% span length (26.4 mm) and strength (21.8 g/t) were found to be nearly the same at all locations. However, the micronaire value varied from 3.7 at Kanpur to 4.9 at Batinda. The strains CSHG.1862, SVHH.139, HSHH.16 were found promising quality-wise at more than two locations.

2. *G.arboreum* Trials :

Co-ordinated Varietal Trial Br.24 : These trials were conducted at seven

locations. Most of the strains from all locations were very short in staple (19.5 mm) length, significantly coarser (7.0 Micronaire) and possessed very low strength around 16.0 g/t. As a result none of the strains was found promising. The strains from Ludhiana centre were subjected to spinning trials but without any success due to poor quality.

Desi Hybrid Trial Br.25 : These trials were conducted at five locations and their strains were tested for fibre quality. However, most of the strains from all locations were of short staple (20.0 mm), very coarse (7.0 Micronaire) and possessed very low strength of about 16.0 g/t and none satisfied the fibre quality norms.

3. ICAR *Bt. Cotton* Trials :

These trials were of two different types viz. one belonging to the first year and other from second year. The first year category had 37 strains whereas second year had 12 strains. Both these trials were conducted at six locations. The strains of first year category had an average value of 2.5% span length and strength as 28.0 mm and 22.0 g/t respectively and there was no locationwise variation. However, the Micronaire value varied from 3.9 (Ludhiana) to 5.1 (Faridkot). The strains with code Nos. 702, 703, 705, 706, 710, 711, 712, 718, 724, 726, 735, 720, 729, 733, 723, 731, 737, 719 were found to be promising. The strains of second year category also

gave the same results as that of first year in respect of quality. In this category only three strains viz. code No.752, 753, 760 satisfied the fibre quality norms. In general, the strains from Ludhiana were finer (3.9 Micronaire) whereas those from Faridkot were comparatively coarser (5.1 Micronaire).

4. Miscellaneous Trials :

The cotton research stations all over India conduct some trials which are not included in regular AICCIP technical programme. Such trials are considered as miscellaneous trials and a brief summary of these trials conducted at different stations are given below :

Kanpur : Two miscellaneous trial 1) Agro 111C and 2) hybrid were conducted at Kanpur. In all 34 samples were tested for fibre properties. On an average 2.5% span length, micronaire and strength values were found to be 25.0 mm, 3.8 and 20.0 g/t respectively.

Sirsa : Four different trials were conducted at Sirsa and totally 54 samples were evaluated for quality parameters. For two Bt trials, the strains were of the long staple type (29.0 mm), finer (4.4) possessing strength around 22.5 g/t. Seven samples from Bt. I trial and three from Bt. II trial were noted to be promising. Further in hybrid trial, MRC.6304, MRC.6029, NCS.913 and JKCH.1947 showed higher strength (23.0 g/t) values. Under demonstration

trial, six samples satisfied fibre quality norms.

CENTRAL ZONE

1. *G.hirsutum* Trials :

Preliminary Varietal Trial (PVT) Br.03 : These trials were conducted both in irrigated as well as rainfed areas. Under irrigated trial Br.03a, the samples were received from four locations whereas in rainfed trial Br.03b they were from seven locations. On an average the values of 2.5% span length, micronaire and strength were 27.0 mm, 4.5 and 22.0 g/t respectively for Br.03a trial and were nearly the same at all the four locations. The strain CCH 1834 was found to perform well at three locations. GSHV.152 and ARBH.813 were also noted to be promising. The strains of Rahuri Centre were found to be in the long category (29.0 mm), finer (3.7) but possessed low strength of about 19.5 g/t. The strains of Br.03b trial were of medium staple (27.0 mm), finer (3.8) possessing strength around 21.0 g/t. The strains HAGH.819, CPD.817, PH.1024, TSH.2005 were found to perform well at more than two locations. The strains from Indore centre gave higher value of strength (23.7 g/t) compared to those from other centres.

Co-ordinated Varietal Trial (CVT) Br.04: These trials were also conducted both under irrigated as well as rainfed conditions. The trials Br.04a as well as Br.04b were conducted at six locations

each. The 2.5% span length, micronaire and strength values were found to be 28.0 mm, 4.4 and 21.0 g/t respectively for Br.04a trial. Only two strains *viz.* P72-9-37 and GSHV 01/1338 were noted to satisfy fibre quality norms (from Banswara and Talod Centres). The fibres pertaining to strains from Khandwa did not give required CSP values for 30s count due to lower strength values. The strains of Br.04b trial were of medium long type (27.0 mm), finer (3.9) having strength around 22.0 g/t. The strains GTHV.0/35 and CCH.226 were found to be promising in performance at three locations. Other strains AKH.9912, KH.155, NH.630 also performed well. In this lot, strains from Bharuch and Bhavanipatna displayed a desirable combination of fibre properties.

Intra-hirsutum Hybrid Trial Br.05 : The samples from irrigated trial Br.05a were received from five locations whereas those pertaining to rainfed trial Br.05b were obtained only from three locations. The strains of Br.05a trial were of long staple type (30.0 mm), finer (4.2) but possessed low strength of 23.5 g/t. The strains GTHH.138, GTHH.119, GGCH.70 from Amminbhavi and Ratna, DHH.462 from Talod were found to satisfy the norms. The 2.5% span length, micronaire and strength values for Br.05b trial were 29.0 mm, 3.4 and 23.0 g/t respectively. The strains NHH.206, VBCH.2231, JKCH.1305, MLCH.318, DHH.66 from Akola and KCH.707, WGHH.311 from

Indore performed well. None of the strains from Nanded centre had satisfactory fibre quality.

2. *G.arboreum* Trials :

Co-ordinated Varietal Trials Br.24 : This trial was conducted only in rainfed areas at eight locations. Most of the strains had medium long fibres around 26.0 mm. However, the strains were very coarse (5.0) and possessed low strength of around 20.0 g/t. The strains from Khandwa were spun to 20s count and the strains JLA.1799, AKA.9703, DLSa.101 and PA.08 gave satisfactory CSP values at the specified count. Due to high micronaire value and low strength none of the strains from other locations were found to be noteworthy.

Desi Hybrid Trial Br.25 : These trials were conducted at 6 locations. In general, the strains produced fibres of medium long category (26.0 mm) at all locations. However, the micronaire values were very high (above 6.0) and strength values were comparatively lower (20.0 g/t). As a result none of the strains had satisfactory fibre quality. The strains of Khandwa centre were spun to 20s count and two strains *viz.* GGCH.81 and Mahabeej DH.903 gave required CSP values at that count.

3. *G.herbaceum* Trial :

Co-ordinated Varietal Trial Br-34-1 : This trial was conducted only at one location, Bharuch. The strains were found to be of short staple (23.0 mm)

type, medium coarse fibres (4.9) displayed lower strength of 19.5 g/t. The strains Ddha.102, GBhv.246, G.Shv.557 possessed satisfactory fibre quality.

4. Inter-specific Hybrid Trial Br.15:

This trial was conducted at three locations. In general, the strains from all the three locations were of extra-long staple (33.0 mm) type with very fine fibres (3.5) possessing strength above 25.0 g/t. The strains GSHB.876, USHB.25, AHB.901, JKCHB.214, PSCHB.901, MLCHB.6 from Anand centre gave good combination of fibre properties. The strains from Banswara gave high strength value but low micronaire whereas those strains from Aurangabad were poorer in fineness as well as strength.

5. ICAR Bt Cotton Trials :

Bt. cotton trials conducted in Central zone were of five different categories *viz.* first year A, first year B, second year, first year HxB, second year HxB. These trials were conducted at eight locations. The samples of first year A category were found to vary in all three fibre properties with respect to locations. While the 2.5% span length varied from 25.9 mm to 30.1 mm, micronaire varied from 2.7 to 4.6 and strength from 18.7 g/t to 23.0 g/t. The strains with code Nos.1017, 1018, 1024, 1025, 1026 from Akola and 1005 from Khandwa were noted to be performing well. Similarly, the values of 2.5% span length, micronaire and

strength varied from 25.7 mm to 29.8 mm, 3.0 to 4.5 and 19.5 g/t to 23.3 g/t respectively for samples from first year B category. Here samples with code Nos.1033, 1040, 1045, 1056, 1057, 1052, 1053, 1035, 1044, 1041, 1042, 1048 were found to possess satisfactory fibre quality as per norms. The samples of second year category were of longer staple 28.0 mm, finer (3.6) but possessed low strength of 21.0 g/t. Location-wise there was very minimal variation. Only two strains *viz.* code No.1061 from Akola and 1069 from Nagpur were found to have satisfactory performance. However, strength values were significantly lower. The strains of first year HxB category were extra long staple (35.0 mm) type, finer (3.2) but having very high strength of 29.8 g/t (for Banswara). Strains with code Nos.1081 to 1092 were found to be worth noting. However, the strains from Indore centre gave lower strength values around 26.0 g/t and only 4 strains *viz.* 1081, 1085, 1086, 1091 were found to be promising in quality. The strains of second year HxB category from Indore centre were of long staple (30.0 mm) type with very low micronaire value (2.9) and lower strength around 24.0 g/t. Only one strain with code 1102 was found to be worth mentioning.

6. Miscellaneous Trials :

Some of the miscellaneous trials conducted at cotton research stations in central zone are briefly presented below :

Akola : Five different agricultural trials were conducted and their samples (241) were evaluated for fibre properties. Agro IV C trial samples were belonging to short staple category (25.0 mm), very coarse fibres (5.3) possessing lower strength around 20.0 g/t. However, Agri IV b samples were better in quality having 2.5% span length 29.0 mm, micronaire 3.5 and strength around 22.0 g/t. The samples of Agro 16 were medium long type (28.6 mm) with finer fibres (4.5) and possessed strength around 22.0 g/t. Eight samples were noted to be promising in quality. Five samples of Agro 1a trial were also of good quality and satisfied fibre quality norms. However, the samples of Agro IV C trial were of very poor strength and none found promising.

Aurangabad : Ten cottons under a Bt trial were tested for fibre properties. Though they were good in length and fineness, most of them had lower strength values (20.0 g/t) and none was found promising. A variety Ajeet 177 was tested for fibre properties and spinning test at CIRCOT as well as at Mill. It performed well at 40s count at CIRCOT. Under mill condition at large scale also it gave a good CSP of 2524 at 30s count.

Banswara : A trial called SCVT-1 was conducted and its samples were tested for fibre quality. Six samples possessed satisfactory fibre quality.

Khandwa : Two trials, *G.hirsutum* and

G. arboreum were conducted and their samples were tested for fibre quality. The varieties JT.110, JT.156 from *G.arboreum* trial and KH.184, KH.81 from *G.hirsutum* trial were found to possess acceptable fibre quality.

Nagpur : Three different trials were conducted and samples were tested for fibre quality. In one of the trial, the samples with codes 702, 711 were found to have satisfactory fibre quality. In another trial the variety Jassi BG II was of long staple type (30.6 mm), finer (4.2) and possessed strength of 23.6 g/t. Similarly, the variety Ankur 8120 BG II also gave nearly same fibre properties at all locations. Thus both these Boll Guard Bt varieties gave stable values location wise.

Nanded : Organic cotton NH.615 was tried at Basmat location and it was found to be of medium long (26.5 mm) with finer fibres (4.0) having low strength of 19.0 g/t. In another trial, the fibre data indicated that normal sowing or delayed sowing did not have any influence on the fibre parameter for Bunny and RCH.2 varieties. Another trial on NH and PH varieties did not show any significant difference in fibre quality.

Surat : A pre-release variety GSHV.01338 was tested for fibre properties and also full spinning test. It performed very well at 40s count. In a trial for management of foliar disease, treatment T1 and T4 gave significantly better fibre quality. In biological control trial for foliar diseases all treatments

RESEARCH ACHIEVEMENTS

gave good results for strength. Similarly, application of biofertilizer was noted to have beneficial effect on fibre quality.

SOUTH ZONE

1. *G.hirsutum* Trials :

Preliminary Varietal Trial Br.03 : Samples under this trial were received from five locations and were tested for fibre properties by using the HVI. In general, the values of 2.5% span length, micronaire and strength were found to be 27.5 mm, 4.2 and 20.5 g/t respectively. However, the strength values were higher (24.0 g/t) at Siruguppa whereas micronaire was higher (5.0) for samples from Coimbatore centre. The strain H.1300 was noted to be promising based on data from three locations. The strains ARBH.813, CPD.812, CNHO.12 were also found to be noteworthy.

Co-ordinated Varietal Trial Br.04 : The samples received from five locations under this trial were tested for fibre properties and a few for spinning tests also. In general, the fibre properties were found to be similar at various locations. The values of 2.5% span length, micronaire and strength were 28.0 mm, 4.4 and 20.0 g/t respectively. However, the strains from Coimbatore centre were comparatively coarser (4.9). The strains of Arabhavi centre were spun to 30s count and most of them performed well at 30s count. The strains ADL.903, HAG.1055,

CPD.787, CCH.1831, GISV.103, GSHV.97/612, NDL.762 gave very good CSP values. The strain CCH.1831 was noted to perform well both at Adilabad and Siruguppa.

Intra-hirsutum Hybrid Trial Br.05 : The samples were received from four locations under Br.05a trial and from three locations pertaining to Br.05b. It was observed that the strains under irrigated trial Br.05a gave almost similar length values (30.0 mm) at all locations. However the micronaire values varied from 3.4 (Hyderabad) to 4.5 (Siruguppa) and strength from 20.1 g/t (Hyderabad) to 25.1 g/t (Siruguppa). The strains RAHH.246, ARCHH.9770, SSB.3, KDCHH.712, PSCHH.1037, JKCH.2245 had satisfactory fibre quality. The fibre quality was found to be acceptable also for strains from Dharwad under Br.05b trial. The strains BSSCH.29, PHCH.72, CAHH.225, VBCH.2510, NCMHH.79 performed very well at 30s count. The strains from Hyderabad and Kovillapatti centres were comparatively of poorer strength at 19.0 g/t.

2. *G.arboreum* Trials :

Co-ordinated Varietal Trial Br.24 : Samples were received from three locations under Br.24b trial. The strains from Dharwad centre were spun to 20s count and the strains DLSa. 102, ARBHA.34, MDL.2647, KWA.23 gave good CSP values at 20s count. The strains from Kovilpatti and Mudhol centres were comparatively

coarser (5.0) and possessed lower strength values around 19.5 g/t and hence not found to satisfy fibre quality norms.

Desi Hybrid Trial Br.25 : The samples were received from five locations under this trial. It was observed that most of the strains from all locations were of medium staple (25.0) category with, very coarse fibres (5.0) and possessed lower strength around 19.0 g/t. As a result none of the strains qualified for further consideration. However, the strain JKCDH.501 from Dharwad centre gave good CSP values at 20s count.

3. Inter-specific Hybrid Trial Br.15:

Out of the samples received from four locations under Br.15 trial, the strains from Attur were of extra long staple (34.7 mm) type, finer (3.2) and possessed lower strength of 24.4 g/t. Though none of the strains satisfied the fibre quality norms, strains like RAHB.170, JKCHB.214, JKCHB.215, PSCHB.901 gave higher strength about 26.0 g/t. The strains from Coimbatore centre gave slightly better fibre properties than those of Attur. The strains AHB 901, JKCKH 215, RAHB 188 gave higher strength values of about 28.0 g/t. The strains from Dharwad centre were spun to 40s count and JKCHB.215, MLCHB.6, JKCHB.214, LISHB.25, PSCHB.901 gave about 2600 CSP values for 40s count. The strains from Davengere centre also possessed higher strength value of 27.0 g/t.

4. ICAR Bt Cotton Trial :

There were five different types of trials conducted under this category in South Zone viz. First year A, First year B, Second year, First year HxB. Second year HxB. Samples received from six locations were assessed for fibre quality.

First Year A : In general, the samples belonged to long staple (30.0 mm) category with finer fibres (4.2) but possessed lower strength of 21.0 g/t. Only two strains with codes 1507, 1508 satisfied the fibre quality norms.

First Year B : The strains of this category also had similar fibre properties as that of 'A' type. Since strength values were lower compared to length, only one strain viz. code 1533 from Coimbatore was found worthy of consideration.

Second Year : Here also the samples fell in the long staple (30.5 mm) category with average fineness (4.5) and possessed lower strength of 21.5 g/t. Therefore, none of the samples from any location was worthy for further trials.

First Year HxB : The samples were found to be in the extra-long staple (34.0 mm) category with very good micronaire value around 3.6 and possessed lower strength around 25.5 g/t. The samples with code Nos. 1502, 1585, 1586, 1583, 1588, 1590, 1591 however had satisfactory fibre quality.

Second Year HxB : Of the trials

RESEARCH ACHIEVEMENTS

conducted at two locations *viz.* Coimbatore and Dharwad, the samples from Coimbatore centre were found to be long staple (32.4 mm) type with finer fibres (4.1) having lower strength of 22.6 g/t. Due to their intrinsic lower strength, none of the samples could be considered for further trials. The samples from Dharwad centre were of extra long staple (33.5 mm) type with very fine fibres (3.2) and possessed strength around 26.1 g/t. The samples with code Nos.1601, 1602, 1603, 1606 were found to perform well.

5. Miscellaneous Trials :

Some of the miscellaneous trials conducted at different centres in South Zone are briefly stated below:

Adilabad : Three different trials were conducted and in all, 152 samples were tested for fibre properties. In general, the samples of all the three trials were belonging to medium staple category (27.0 mm) with very fine fibres (3.4) possessing very low strength of 20.8 g/t. However, none of the samples satisfied the fibre quality norms.

Coimbatore : In all, seven miscellaneous trials were conducted. In one of the pre-release trial, the variety CCH 510-4 gave very good performance at 60s count. In other three trials, the samples were found to be in the long staple (29.0 mm) group with very coarse (4.8) fibres having very low strength around 20.0 g/t. In agronomy trial, the samples were noted to be extra-long (33.0 mm) type

with good micronaire value of 4.1 but possessed lower strength of 23.0 g/t. The samples of Bt cotton trials were also from the long staple (32.5 mm) category with average fineness (4.4) and very low strength of 21.0 g/t.

Dharwad : In all 252 samples were tested for fibre properties from eight different trials. The samples of private Bt cotton trials were in the long staple (29.5 mm) category with finer fibres (3.6) having very low strength of 21.2 g/t. Similarly the samples under agronomy trials were also found to belong to long staple category (31.0 mm) with finer (4.0) fibres but possessing lower strength of 21.0 g/t in general and thus none of the samples was worth promotion.

Hyderabad: Under a pre-release trial, the variety JKCH.1050 had good fibre quality and performed well at 40s count.

Mudhol: The samples of a miscellaneous trial conducted at Mudhol gave 2.5% span length, micronaire and strength values as 28.6 mm, 3.5 and 20.3 g/t respectively. Due to poorer strength value none of the samples could be considered for further trials.

National Trials:

Eleven trials were conducted. A brief summary about each trial is presented below and also in Table 4.

1. Initial Evaluation Trial Br.02a :

This trial contained 40 strains and

were conducted at seventeen locations. In general, the values of 2.5% span length, micronaire and strength were found to be 27.0 mm, 4.4 and 21.0 g/t respectively and the values of fibre parameters were nearly the same at all locations. In all 106 samples were found to satisfy the fibre quality norms. Amongst them, the strains RS.2513, TSH.2005, BS.277, CSH.3047, H.1316, GISV.218, LH.2107 were noted to perform well at more than four locations.

2. Initial Evaluation Trial Br.02b :

This trial involving thirty-four strains were conducted at eleven locations. In general, the values of 2.5% span length, micronaire and strength were around 26.5 mm, 3.8 and 20.0 g/t respectively. However, the values of fibre parameters for strains from Akola, Bhavanipatna, Adilabad, Bharuch were better (28.4 mm, 4.0, 22.2 g/t) as compared to those from Indore, Khandwa and Banswara. In all, twenty samples satisfied the fibre quality norms. Amongst them the strains IH.10, TSH.9974, GISV.206, P.21-15, GISV.218 were noted to perform well at more than two locations.

3. Intra-hirsutum Hybrid Trial Br.05a-1 :

This trial consisted of thirty-seven hybrid strains and was conducted at seventeen locations. On an average the values of 2.5% span length, micronaire

and strength were found to be 29.0 mm, 4.0 and 21.5 g/t respectively. However, the strength values were higher (23.6 g/t) for strains from Faridkot and Talod whereas it was on the lower side (20.0 g/t) for strains from Coimbatore, Rahuri and Hyderabad. Similarly the strains from Coimbatore, Hisar and Talod were coarser (4.7) whereas, those from Jalna, Sriganganagar, Warangal were comparatively finer (3.5). The 2.5% span length was nearly same at all locations except at Sriganganagar where it was only 25.4 mm. In all 60 samples from seventeen locations were noted to have satisfactory fibre quality norms. Amongst them, the strains VICH.121, Prateek 7, HSHH.18, ARCHH.7252, Indam 1020, RAJHH.729, CSHH.132 were found to perform satisfactorily at more than three locations.

4. Intra-hirsutum Hybrid Trial Br.05a-2 :

This trial contained sixteen entries and it was conducted at eleven locations. In general, the samples were found to be belonging to the long staple (28.5 mm) category with finer fibres (4.2) and possessed average strength of 22.0 g/t. The strains from Surat centre gave highest strength of 24.8 g/t but they were found to be comparatively coarser (4.8). Twenty samples satisfied the fibre quality norms from different locations under this trial. Amongst them the strains DMSHH.504, DMSHH.505, CSHG.2612, LMSH.214

had promising performance at more than two locations. The strain CSHG.3108 had better quality at five locations.

5. *Intra-hirsutum Hybrid Trial Br.05b-1 :*

This trial comprising twenty-two strains was conducted at eight locations. In general, the values of 2.5% span length, micronaire and strength were found to be 28.5 mm, 4.2 and 21.5 g/t respectively. It was observed that the 2.5% span length was nearly the same at all locations. However, the micronaire values varied from 3.3 at Akola and Indore to 4.6 at Bhavanipatna and Kovilpatti. Similarly, the strength also varied from 18.1 g/t at Kovilpatti to 23.5 g/t at Dharwad and Akola. In all 18 samples had satisfactory fibre quality and amongst them the strain GGCH.50 was noted to have better performance at four locations. The strains RAHH.231, GAGHH.133, SP.671, ARCHH.3028 were noted to be performing well at more than two locations.

6. *Intra-hirsutum Hybrid Trial Br.05b-2 :*

This trial contained ten entries and was tried at six locations. In general, it was observed that the 2.5% span length and strength values were 28.0 mm and 22.5 g/t respectively and were nearly the same at all locations. However, the micronaire values varied from 2.8 (Indore) to 4.4 (Amreli). The

strain RAM SHH7 was found to perform well at two locations. Other strains CAHH.232, DMSH.0771, DMSH.0772 were also found to satisfy fibre quality norms.

7. *Co-ordinated Varietal Trial Br.14 :*

This trial including eight entries and at four locations had samples in the extra-long staple (above 33.0 mm) category with finer fibres (3.7) possessing high strength around 28.0 g/t. However, the samples from Rahuri centre gave lower strength (24.0 g/t) and micronaire values (3.0). The strains CCB1, CCB.2, DCB.1, DCB.2, TCB.1 were found to have satisfactory performance at more than two locations.

8. *Inter-specific Hybrid Trial Br.15:*

This trial contained twenty hybrids and was conducted at six locations. In general, all the three fibre parameters were found to vary location wise. The 2.5% span length varied from 33.0 mm (Dharwad) to 37.4 mm (Talod) while, the micronaire varied from 3.0 (Dharwad) to 3.9 (Coimbatore). The strength values also had a variation from 26.0 g/t (Coimbatore) to 32.0 g/t (Talod). The strains GSHB.895, CCCHB.07-1, GGCH.90, RAHB.163, Sara 2, HAGHB.12, AACH.3466, CCHB.2628 had satisfactory fibre quality. The strain Sara 33 was the best performing at all the six locations.

9. *Initial Evaluation Trial Br.22 (a/b) :*

This trial contained thirty entries and was tried at seventeen locations. In general, most of the strains were of medium staple (25.0 mm) type, very coarse (5.6) in nature and possessed lower strength around 19.0 g/t. The strains RAC.24, CAN.1001, CINA.348, GAM.141, CISA.108 were nearly satisfying the fibre quality norms at more than three locations and stood out among the lot.

10. *Desi Hybrid Trial Br.25 :*

Under this trial fourteen entries were tried at thirteen locations. In general, most of the samples from all locations were of short staple (22.0

mm) type with very coarse (above 5.0) fibres and lower strength of 18.0 g/t. As a result no strain from any location was worthy of consideration. However, strain JKDCH.505 was found to nearly satisfy fibre quality norms at two locations.

11. *Co-ordinated Varietal Trial Br.34 :*

This trial consisting of twenty-six entries at one location only viz. Bharuch with two different plots had short staple fibres (23.0 mm) with very coarse (5.0) and lower strength of 19.5 g/t. The strains GBhv.253, Gshv.578/02, GVhv.544, RAHS.157, RBDV.17, GBhv.259, GBhv.262, GBhv.267, GVhv.531 were better among the lot in terms of fibre quality.

TABLE 4 : SUMMARY OF NATIONAL TRIALS

Trial	No. of Entries	No. of Locations	Range of Fibre Traits		
			2.5% SL (mm)	Micronaire	Bundle Tenacity (3.2 mm g/t)
Br.02a	40	17	25.8-28.9	3.7-4.8	19.9-23.3
Br.02b	34	11	24.7-28.9	3.4-4.4	19.1-22.8
Br.05a-1	37	17	25.3-30.2	3.3-4.8	19.9-23.9
Br.05a-2	16	11	25.7-29.7	3.9-4.8	20.6-24.8
Br.05b-1	22	8	27.1-30.5	3.2-4.6	18.1-23.5
Br.05b-2	10	6	27.3-28.8	2.8-4.4	21.6-23.1
Br.14	8	4	32.6-37.4	3.0-4.4	24.1-30.8
Br.15	20	6	32.9-37.4	3.0-3.9	25.9-32.0
Br.22 (a/b)	30	17	21.7-26.1	4.8-6.3	16.7-21.5
Br.25	14	13	20.6-24.8	5.5-6.8	17.2-21.0
Br.34	26	2	20.6-26.2	3.8-6.2	17.2-23.8

(b) Tests on Standard and Trade Varieties of Indian Cottons

Evaluation of Quality of Major Trade Varieties Grown in Different Parts of the Country

During this period from the 2007-08 season, 92 trade variety samples were received from different locations such as Haryana, Gujarat, Maharashtra, Karnataka, and Tamil Nadu. The fibre, spinning and yarn tests on 20 samples have been completed.

From 2008-09 season, 73 Trade variety cotton samples have been received from Punjab, Haryana, Rajasthan, Maharashtra and Andhra Pradesh.

Evaluation of Quality of Standard Varieties of Indian Cotton

From 2007-08 season, 54 cotton varieties grown under standard conditions received from different Agricultural Universities and their regional units were subjected to fibre, spinning and yarn tests and the test reports were issued in the form of Technological circulars.

(c) Research work done on specific agricultural and technological aspects relevant to improvement of cotton attributes

Demand Model for the Consumption of Cotton Fibre in Textile Sector

The demand for raw cotton is a derived one which depends mainly upon the demand for cotton yarn, which in turn depends upon that of the cotton fabric in domestic and international markets. The domestic demand for cotton is specified

as a function of domestic price of cotton, beginning stock of cotton and the cotton yarn price. The cotton yarn price is found to be a better indicator of demand for cotton yarn compared to the spinning industries utilization capacity. The new model shows a better fit with R square value of 0.98 and the forecast stability of the model was better with Root Mean Squared Error (RMSE) value of 93.61 and the thiel's inequality coefficient at around 0.019.

The export demand for raw cotton was fitted as a function of domestic price of cotton, international price of cotton after adjusting for exchange rate variations, beginning stock, world cotton consumption and the domestic production to consumption ratio. This model showed a better fit with R square value of 0.91. All the variables were found to be significant at 1% level except for international price and world cotton consumption which were significant at 10% level.

The forecast values for out of sample period was made using the model and compared with the actual consumption. The model based forecast was also compared with forecast using exponential smoothing technique and found to perform better (Table 5 and 6).

Fabrication and Evaluation of an Instrument for Measurement of Electrical Properties of Textile Materials

Fabrication of an instrument for

TABLE 5 : PROJECTION OF DEMAND FOR RAW COTTON

Year	Actual Value	Projection based on Model
2004	3222.35	3137.65
2005	3440.08	3450.70
2006	3646.92	3686.09
2007	3701.00	3619.15
2008	3601.00	3532.04

TABLE 6 : PROJECTION OF DEMAND FOR RAW COTTON EXPORTS

Year	Actual Value	Projection based on Model
2004	143.70	279.19
2005	707.61	735.45
2006	925.33	825.06
2007	1445.00	1205.73
2008	850.00	994.128

testing the electrical properties of textile materials has been completed (Fig. 5). The circuit diagram of the experimental set-up and cross section of the instrument are given in Fig. 6. The performance of this instrument was judged by testing different kinds of textile samples as given below in Table 7. About 25 fabrics have been tested so far. For each test five readings at four varying voltages were taken. It was found that the control fabrics have

the electrical resistance in the range of 10^9 to 11^{11} ohms with an accuracy of + 2% of the reading.

Structure-Property Relationship in Friction Spun Yarns (DREF)

During the reporting period of the project 17 DREF yarn samples of various core (nylon6) and sheath (cotton) ratios ranging from 14 – 71% were produced by using the DREF-3000

TABLE 7: ELECTRICAL RESISTANCE AND CONDUCTANCE MEASURED FOR DIFFERENT FABRICS

Type of samples	Electrical Resistance, R (Ohm)	Mean, R (Ohm)	Conductance, G (Mho)	Mean, G (Mho)
White cotton (100%) fabric	1.10×10^9 0.970×10^9 0.954×10^9	1.008×10^9	0.909×10^{-9} 1.030×10^{-9} 1.048×10^{-9}	0.995×10^{-9}
Cotton (Cotton-80% & Polyester-20%) Blended fabric	0.875×10^9 0.870×10^9 0.782×10^9	0.843×10^9	1.142×10^{-9} 1.149×10^{-9} 1.278×10^{-9}	1.189×10^{-9}
Control Synthetic Fabric	0.139×10^9 0.141×10^9 0.135×10^9	0.138×10^9	7.194×10^{-9} 7.092×10^{-9} 7.407×10^{-9}	7.231×10^{-9}

RESEARCH ACHIEVEMENTS

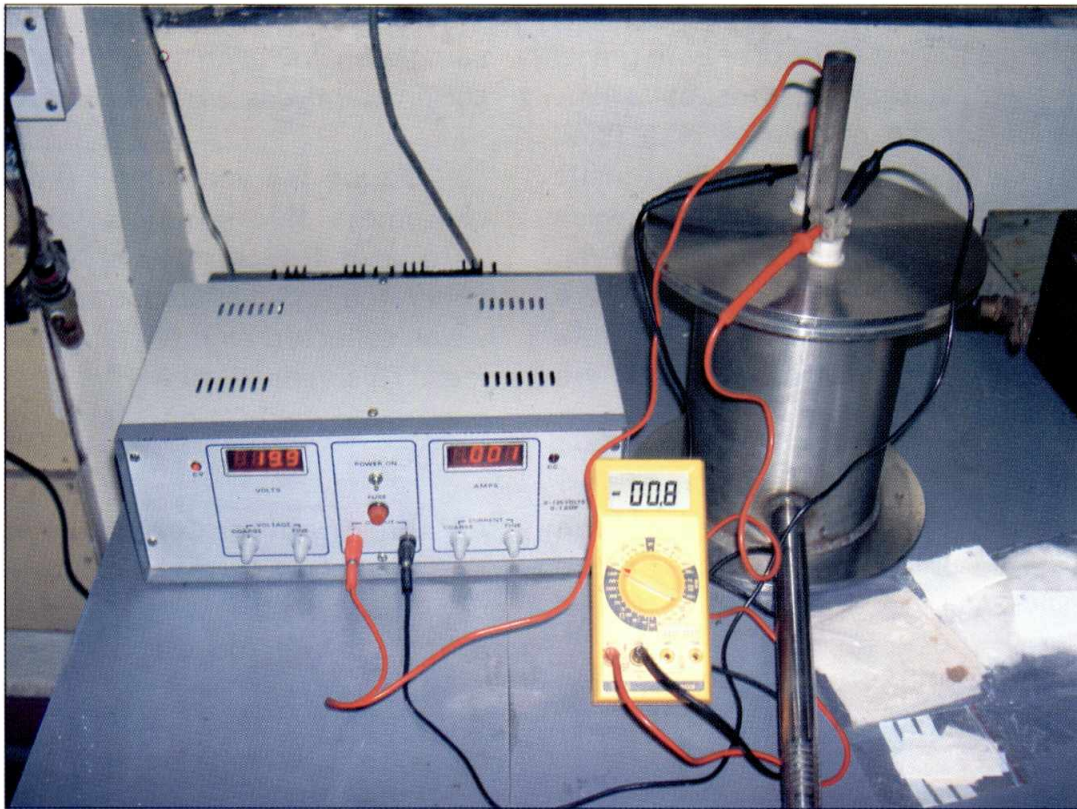

Fig. 5. Set-up for Measuring the Electrical Conductivity of Textile Material

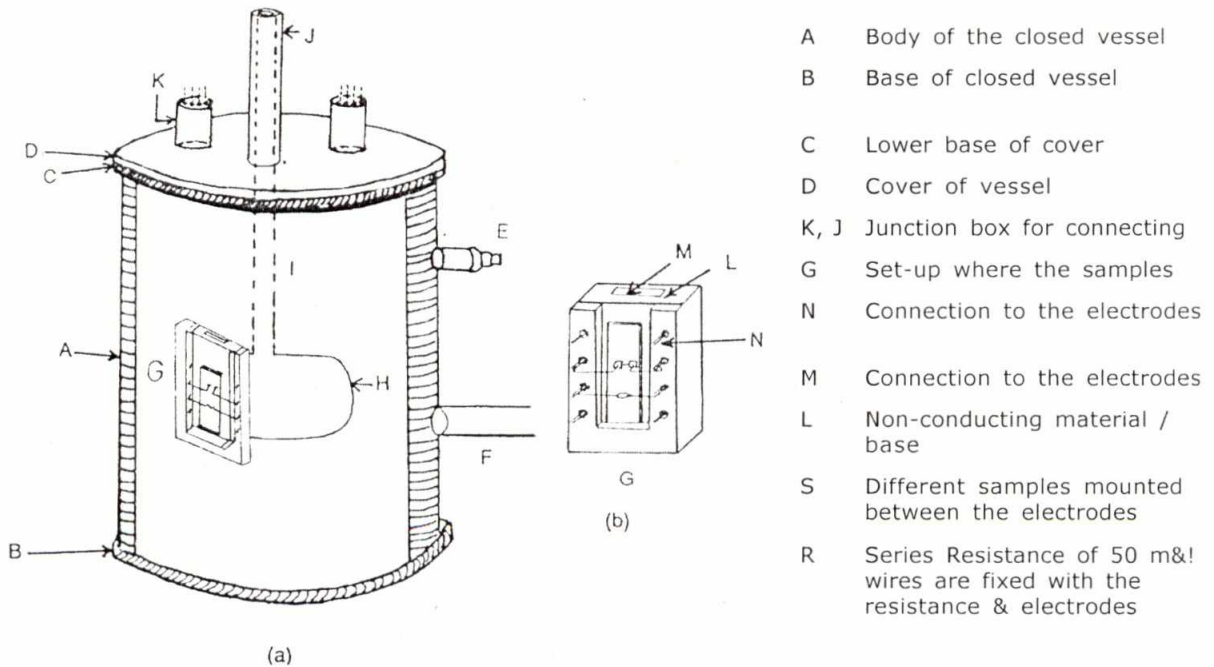

Fig. 6. Cross-section of the Experimental Set-up

machine. While preparing the first 9 yarn samples, different rates of sheath (inlet) were given, so that the effect of various inlets on tensile properties of a fixed count could be studied. The tensile properties of these yarn samples such as breaking strength, elongation %, work of rupture and tenacity were estimated. From the analysis of data following information could be gathered:

- (i) No significant effect was noted for various inlets of sheath on the tensile properties of a fixed count DREF yarn.
- (ii) Tensile properties depended upon the core ratio of DREF yarns.
- (iii) Tensile properties such as breaking strength, work of rupture and tenacity of DREF yarns increase with core ratio.

EXTERNALLY AIDED PROJECT

Preparation and Marketing of CIRCOT Calibration Cotton Standards

During the year under report, two cotton samples *viz.* Jayadhar and DCH.32 of one bale each were purchased from Dharwad and Sindhanur in Karnataka and processed to prepare standards. Testing of these cottons for fibre properties and Inter Laboratory Test No.13 has been completed. Making use of the results of Inter Laboratory Tests and in-house test results, the standard

values have been assigned and these samples have been introduced as new cotton standards *viz.* HM- 9 and HE- 8.

During the year under report, 796 containers of calibration cotton were sold and Rs. 4,45,321/- revenue generated. In addition to this Rs. 17000/- was collected as inter laboratory test fees. This year 27 new HVI users have purchased calibration standards from CIRCOT.

A Value Chain for Cotton Fibre, Seed and Stalk: An Innovation for Higher Economic Returns to Farmers and Allied Stake Holders

This is a project funded by National Agricultural Innovation Project (NAIP) with CIRCOT as a lead Institute and CICR, Nagpur and Super Spinning Mills, Coimbatore as Partners. The project aims to establish value chain in cotton crop for best utilization of lint, seed and other bio-mass for the benefit of farmers and other stakeholders.

Under this project, ELS cotton variety RCHB.708 Bt. was grown in Vadapudur (village), Kinathukadavu (Block), Pollachi (TK), Coimbatore district, Tamil Nadu, in about 130 acres of land and Bunny Bt. cotton at Babulgaon in Yeotmal district of Maharashtra. More than 130 farmers were associated in the project. Cultivation know-how and supervision has been provided by the Scientists from CICR. Importance of clean cotton picking, proper storage and

RESEARCH ACHIEVEMENTS

transportation were imparted to farmers by CIRCOT scientists. About 700 quintals of *kapas* was procured at Coimbatore and about 350 quintals of *kapas* at Nagpur. *Kapas* was ginned at respective places. Sixty-seven bales have been pressed at Nagpur and 147 at Coimbatore. The highlight of the programme is that almost no contamination is observed as a result of awareness created among farmers about clean cotton picking by CIRCOT.

Fibre samples from each bale were collected and evaluated for fibre parameters using the HVI. Bales at Nagpur have already been tagged with these fibre attributes. Some initial trials on bio scouring of yarn have been carried out. These yarns were then dyed with natural dye. Results are encouraging. Cotton stalk in the farmer's fields at Nagpur have been cleaned of boll rinds. Chipping operation is in progress. Delinting of ginned seed using enzyme pre-treatment has been carried out on an experimental scale. Results show about 15% increase in *kapas* yield as compared to control.

A Value Chain on Banana Pseudostem for Fibres and Other Value Added Products (Component 2)

India has a large area under banana cultivation which is estimated to yield more than 500 lakh tones of pseudostem annually. From this biomass more than 3.40 lakh tonnes of fibres can be extracted, the value of which works out to Rs. 1500 crores.

During the process of fibre extraction huge quantity of sap (liquid) would also be generated which is a rich source of Potassium (4% dry weight basis). Potassium worth of Rs. 46 crores could be obtained from the sap. In addition to these, fibre as well as scutching waste made available could be utilized for paper and board making. The scutching waste can also be used for preparing enriched vermicompost. Similarly, from the central core, the tender part of banana pseudostem, edible products could also be prepared. In order to explore the various products from banana and especially the fibre, a project was under taken under NAIP with Navsari Agricultural University as the Principal Leader and CIRCOT as its partner. The objectives of the project are as follows:

- ♦ Standardise a process for extracting textile grade fibres from pseudostem and prepare home furnishing
- ♦ Standardise a process for pulp and paper making from pseudostem, fibres and waste both at hand made and industrial levels.
- ♦ Develop value added edible products from the central core.
- ♦ Preparation and evaluation of enriched sap and scutching waste vermicompost.
- ♦ Develop linkage for marketing of pseudostem based products.

During the reporting period, the Raspador was installed at Navsari

Agricultural University, Navsari. Standardization of machine parameters has been completed. Extraction trials were taken up successfully.

The effect of microbial retting on softening of banana fibres as well as extraction of fibres from sheaths by a microbial treatment were carried out; preliminary trials were undertaken to treat ready-to-dye cotton fabric with sap as a mordant. Colour fastness properties are under study. During this period laboratory scale trials for the preparation of cellulose powder were completed.

Design and Development of Rubber Dams for Watersheds (NAIP Component 4)

India is largely an agriculture driven economy. Water/Rain harvesting and management is a major activity for reaping the benefits of agriculture. Many small and large watersheds or check dams spread all over the country contribute in a major way towards this objective of water management especially for small farmers with small land holdings. Construction and maintenance of concrete dams involve lot of physical, logistical and financial constraints. Hence the concept of collapsible (inflatable - deflatable) rubber dams to manage at least the medium and small sized watersheds and minimize rain water runoff has been mooted in this project. Such rubber dams installed for river water management are already success in

countries like Austria, Bangladesh, etc. In India, there is an Austrian make rubber dam installed on Janjavati river at Parvathipuram in Vijaynagar district of Andhra Pradesh.

This project aims at developing an indigenous rubber check dam to be installed in the watersheds. Rubber dams have an appropriately engineered fabric with adequate and optimum strength and flexibility. It is bonded with a suitable rubber component which forms the fabric - rubber reinforcement membrane. The rubber acts as waterproof to the fabric and prevents water seepage through the fabric barrier. Adhesion between the fabric and the rubber (e.g. peel strength) should be sufficiently high enough to withstand the rigor associated with such application during the life cycle of the dam. CIRCOT, as a partner in this project, is instrumental in developing suitable fabric having all the above qualities to be bonded with the rubber component.

1. Improvement of fabric to rubber adhesive strength:

For satisfactory binding of technical fabric with rubber an additional adhesive treatment is needed. In most cases, it is RFL (Resorcinol formaldehyde latex) adhesive formulation. For the initial nine fabric samples produced from Nylon 6 in this project, an appropriate adhesive latex formulation has been developed, which provided a good peel strength (the adhesion strength between fabric and rubber) ranging from 7.9 to

RESEARCH ACHIEVEMENTS

14.1kg/25mm. The maximum target set was 7.6 kg/25mm for better functional characteristics of rubber textile composite and for improved life of rubber dam (Fig. 7).

2. Selection of fabric type, GSM and Weave:

Based on the various experiments, which were analysed following DOE (Design of Experiment) method, Nylon 6 and fabric weave design, its GSM and quantum of adhesive application have been optimized.

Mock leno showed higher peel strength than other weaves with similar

material and GSM, due to its more porous structure enabling better penetration of adhesive material.

3. Reverse Engineering of Jhanjavati Dam Fabric :

Based on the analysis done on fabric substrate separated from rubber pieces, which were collected from Jhanjavati Rubber Dam site following reverse engineering, a fabric sample could be recreated with the active participation of M/s. Kusumgar Corporates. This activity demonstrated that it is possible to produce heavy duty fabric geo-membrane indigenously for construction of large dams on rivers.



Fig. 7. Adhesive Bonding of Textile Reinforcement

4. Fixation of tentative specifications of fabric Reinforcement:

The following technical specifications of fabric reinforcement were arrived at and fixed for fabricating proto dams to be used in the watersheds.

- Fabric breaking strength: 700 Kg/cm
- Peel (adhesion strength): 4 Kg/cm (10kg/25mm)
- Grey fabric thickness: 0.6 mm
- Finished fabric thickness: 10 mm

For the purpose, the following two fabric selections have been made in the present study as per the optimization trials.

Set No.	Fabric	GSM	Weave type
1	Nylon 6	450	Mock leno
2	Nylon 66	550	Mock leno

The rubber composite material will be constructed as per the following specifications:

- Fabric substrate – 2 layers with 1mm thickness for each layer.
- Rubber friction compound – 1 no. with thickness of 1mm.
- Rubber covers compound – 2 no. with 1.5 mm thickness of each.

Thus, the total thickness of the composite is 6 mm.

CORE AREA III : FINISHING AND DYEING OF COTTON WITH NATURAL AND ENVIRONMENT FRIENDLY AGENTS

Production of Xylanase by Aspergillus niger sp. through Solid State Fermentation and its Application to Lignocellulosic Materials

Xylanase is an enzyme which hydrolyses xylans, which are complex heteropolysaccharides. It is produced either by bacteria, fungi or other organisms. Most fungal cultures secrete cellulose more than xylanase. Hence, there is always a search for organisms which produce xylanase in large quantities compared to cellulose. It has been found that a culture of *Aspergillus niger v. Tieghem* (MTCC) produced more xylanase and less cellulose.

During the year under report, the xylanase produced by *Aspergillus niger sp.* was concentrated by ultrafiltration and acetone precipitation methods. The results showed that the enzyme concentration was increased by four fold while the specific activity (xylanase activity/mg protein) was enhanced by 3.3 fold.

Various lignocellulosic materials viz. cotton stalks, wheat straw, rice straw, bajra straw were hydrolysed by cellulase and a mixture of cellulase and *A. niger sp.* xylanase for 24 h and a 48 h and production of reducing sugars

RESEARCH ACHIEVEMENTS

was estimated. There was an increase in production of reducing sugars when the lignocellulosic materials were treated with a combination of cellulase and xylanase. Maximum reducing sugars were produced from bajra straw while cotton stalks yielded very low values. These results indicated that xylanase from *A. niger sp.* could hydrolyse hemicellulose present in the lignocellulosic materials considered above.

In another set of experiments, the lignocellulosic materials were separately treated with cellulase and xylanase. The results confirmed that xylanase can degrade the lignocellulosic materials. Further, xylanase could readily hydrolyse Bajra straw while its action on cotton stalks was very slow.

DP Finishing of Dyed Fabric

A project was undertaken to study the compatibility of dyeing with durable press finish as applied to cotton fabrics by employing PCA. During the reporting period dyed and treated fabrics were estimated for fabric handle and comfort properties.

For samples treated with reactive blue and red dyes, it was observed that for each of the three different shades at a pH of 3.5 gave the highest value for Koshi (stiffness) indicating that the cross-linking treatment is most effective at this pH (3.5) as compared to pH 4.5.

At the same time, the Numeri

(Smoothness) was observed to decrease for pH 3.5 as compared to pH 4.5. In the case of red dyed fabric, Fukurami (fullness and softness) was noted to decrease after treatment, while for the blue dyed fabric it showed an increase for the fabric treated at pH 3.5. The air-permeability was observed to increase for both blue and red dyed fabrics (Dyed fabric is not nailed or stretched). Moisture transport for 0.5% shade (both red and blue dyed) fabric did not show any significant change after treatment. The moisture transport for 1.5% dyed fabric showed an increase after treatment for both the dyed fabrics. On the other hand 3% dyed fabric showed a decrease in the moisture transport after treatment.

Thermal insulation value for the red dyed fabric was noted to be higher than the blue dyed fabric for control as well as for treated samples. For 0.5% dyed fabric, TIV showed no significant change after treatment for both red and blue dyed fabrics, whereas 1.5% and 3.0% dyed fabrics showed marginal decrease after treatment for both blue and red dyed fabrics.

Scaling up trials were conducted to have durable press finish. Treatment with Polycarboxylic acid as cross linking agent was carried out both on dyed as well as printed fabrics. DP finished fabrics showed good colour strength, durable press, breaking strength and comfort properties as compared to control.

The handle properties of treated

fabrics showed better resiliency which means that the fabrics tend to easily return to their original position and hence are less likely to form wrinkles.

In the case of both dyed and printed samples, the treated fabrics presented a much smoother surface compared to their control. The treated fabrics displayed reduced stiffness (koshi) and softness (Fukurami) values. The surface smoothness (Numeri) was seen to improve with treatment. The total hand value did not show any significant difference between the treated and control fabrics. In other words, the treatment did not result in any deterioration in the fabric hand.

Ecofriendly Pre and Post Processing of Fabric Prepared from Organic Cotton and Finishing with Chitosan

Woven and knitted fabrics prepared from organic cotton were evaluated initially for their physical properties without any treatment. Both woven and knitted fabric samples were treated with pectinase for scouring purpose and bleached with hydrogen peroxide. Simultaneously, the fabrics were also scoured by the kier boiled process and bleached with hydrogen peroxide. All the fabric samples (Fig. 8) were evaluated for various physical and mechanical properties. The results indicated that the absorbency was instantaneous in bioscoured as well as conventionally scoured fabric samples.

Chitosan treatment was given to the bioscoured and bleached woven fabric sample and evaluated for antibacterial activity. A 99% reduction in bacterial count was observed. Further work on effect of washing cycles on antibacterial properties of the fabric is in progress. Simultaneously, woven and knitted fabrics scoured and bleached were dyed with chrysanthemum flowers. K/s value of enzymatically scoured and bleached fabric samples was slightly higher than the conventionally scoured and bleached fabrics.

Development of Protective Clothing for Pesticide Spraying Operation

Two medium weight plain weave 100% cotton grey fabrics were tested for pesticide repellency, retention and penetration using ISO 22608 : 2004 method A (gravimetric method) against 5% pendimethalin (Prowl, BASF, USA) solution. Repellency was not observed and average pesticide penetration through these fabrics was ~ 79% for the denser fabric and 85% for the less dense fabric. Desizing reduced the pesticide penetration to 65% and 68% respectively perhaps by increasing the absorbency but it was still much higher than the acceptable range of 5-40%.

Five more grey 100% cotton fabrics of different construction and weight/m² were procured and subjected to one and five hand washes as per AATCC 135-2004 standard procedure. Wetting time of washed samples was

RESEARCH ACHIEVEMENTS



Fig. 8. Organically Produced Cotton Fabric after different finishing treatments

determined by drop absorbency method (IS 2349-1973) which ranged from 23 sec. to > 180 sec. for fabrics washed once and < 1 sec. to 35 sec. for fabrics washed five times. All washed samples were tested for percent pesticide penetration, retention and repellency against 5% pendimethalin (Stomp, BASF, India) solution using the ISO method. Percent pesticide penetration through samples washed once ranged from 22-44. Pesticide penetration through samples washed 5 times was lower and ranged from 17-35 which was within the acceptable range. Improvement in pesticide protection

here may be due to higher absorbency. Ironing these samples increased the pesticide penetration slightly. As expected, heaviest fabric showed lowest pesticide penetration.

Production of Titanium Dioxide Nanoparticles and their Application in Cotton Textiles for Antibacterial and Self-Cleansing Properties

Titania nanoparticles have been synthesized by using two different precursors namely titanium isopropoxide and titanium IV chloride; and starch as stabilizing agent. The

presence of starch may restrict the size of the titania particles formed during hydrolysis / condensation. These materials were washed with water and calcined at 400 °C to get crystalline titania. The product was characterized by X-ray diffraction, UV-visible spectrophotometer and spectrofluorimeter. Nano-titania showed blue shift in absorption spectrum due to its increase in band gap at nanoscale. The characteristics of prepared nano-titania by four different processes are given in Table 8.

As the size decreased, the absorption maximum shifted towards the UV region (blue-shift). This supports the quantum confinement effect of semiconductor materials. The size of the nano-titania was estimated by DLS (dynamic light scattering) particle size analyser and confirmed by Transmission Electron Microscopy. Two different morphologies (rod and spherical) of nano-titania were noticed in TEM images (Fig. 9). The 100% cotton fabrics (kierboiled & bleached) were dip coated with the nano-titania and analyzed for their antibacterial and

dye-degrading properties (self-cleaning). There was neither antibacterial nor dye-degradation activity in the coated fabric. The entire process is now being carried under UV-light (inside a photo stability chamber) so that photo catalytic nature of titania can be utilized to induce the functional properties.

EXTERNALLY AIDED PROJECT

Synthesis and Characterization of Nano-cellulose and its Application in Biodegradable Polymer Composites to Enhance their Performance (NAIP: Component IV)

Cellulose is the most abundant organic polymer occurring in plants, algae, few marine organisms and bacteria. Apart from available in various cellulose containing crop-residues, cellulosic fibres of plant origin can be grown in varied agro-climatic conditions. Value addition to cellulose is carried out by acid hydrolysis to yield microcrystalline cellulose (MCC) for various applications. However, the low aspect ratio and intervening amorphous

TABLE 8: CHARACTERISTICS OF NANO-TITANIA PREPARED BY VARIOUS PROCESSES

Process	Precursors	Stabilizer	pH	Size (nm) by DLS particle size analyzer	λ_{max} (nm)
A	Titanium Isopropoxide	Nil	2.2	133.1 ± 35.6	300
B	Titanium Isopropoxide	0.5 % Starch	7.0	128.9 ± 35.6	280
C	Titanium Isopropoxide	0.5 % Starch	2.2	150.1 ± 41.1	287
D	Titanium tetra chloride	0.5 % Starch	2.2	188.3 ± 45.1	305



Fig. 9. TEM Image of Nanoparticles of Titanium dioxide (Scale bar = 200 nm)

region make it unfit for use as fillers in composites. Hence, the preparation of nanocellulose and their use in various composites will be a value addition to non-spinnable cotton, cotton linters and other cellulosic biomass. The tensile strength of ramie, flax, jute, wood and cotton is well below 1.0 GPa while that of cellulose nano-crystals is 10 GPa and this explains the projected use of nanocellulose in composites.

Despite the availability of biodegradable polymers, lack of structural and functional stability prevents their commercial use as agricultural mulch films and food packaging films. Though there is a strong potential for low-cost starch and cellulose based polymers for commodity applications, high water vapour permeability and poor mechanical strength prevents their large scale exploitation. The use of nanocellulose as filler could improve the performance of these biodegradable

films due to its high crystallinity and better interfacial interaction.

With this background information, a four years project from July 2008 to March 2012 under funding from NAIP programme was undertaken with the active collaboration of the Institute of Chemical Technology, Mumbai. The project has a twin objective.

- ✓ To prepare nano-cellulose (nanowhiskers and nanofibrils) from cotton and cotton linters by novel microbial, enzymatic and chemo-mechanical processes and their characterization.
- ✓ To prepare the polymer nano-cellulose composites and to evaluate their mechanical, barrier and biodegradability attributes.

A brief summary of the progress made in the project under different objectives is presented below:

Objective 1: To Prepare nano-cellulose (nanowhiskers and nanofibrils) from cotton and cotton linters by novel microbial, enzymatic and chemo-mechanical processes and their characterization.

Activity 1. Identification of appropriate pretreatment for MCC prepared from cotton and linters to make it amenable for microbial and enzymatic processes.

During the period microcrystalline cellulose (MCC) was prepared from 'Bengal Desi' cotton fibres by

conventional dilute acid hydrolysis (2.5N HCl; 100°C). Fenton's chemistry was tried on MCC to loosen the surface chemical structure. No enhancement in enzymatic activity was noticed with Fenton's reagent treated MCC up to the ratio of 10:1:30 [MCC:FeSO₄:H₂O₂, wt. ratio]. In contrast, reduction in enzymatic activity was noticed that may be attributed to the inhibitory effect of 'Fe' element present on the surface of MCC.

Activity 2. Microbial process for preparation of cellulose nano-whiskers

The fungus, *Trichoderma reesei* (strain: MTCC - 164) was used for the hydrolysis of MCC under submerged fermentation condition. Both the cellulase activity and particle size distribution were monitored up to 5 days. The formation of nanocellulose was found after 24 h of fermentation that was indicated by the development of new peaks below 1000 nm in particle size analysis by dynamic light scattering process. Very fine sized particles (<100 nm) were formed after 5 days of incubation (Fig. 10). Traditional concentrated acid hydrolysis was carried out to prepare nanocellulose resulting in average diameter of 182.4 nm. This was used as a standard for comparison (Fig. 11).

Activity 3. Enzymatic process for preparation of cellulose nanowhiskers

For the enzymatic hydrolysis, commercially available cellulase

enzyme was used and the percent saccharification of the substrate (MCC) over a period of 5 days was monitored. As the substrate used was in excess, there was simultaneous formation of small sized particles from the MCC particles and so, at any point of time, the particles in the range of 10000 nm dominated the scattered light intensity in particle size analysis. So, linear trend in particle size reduction during incubation could not be noticed.



Fig. 10. SEM Image of Nanocellulose Prepared by the Fungus, *Trichoderma reesei* (Scale bar = 1 μm)

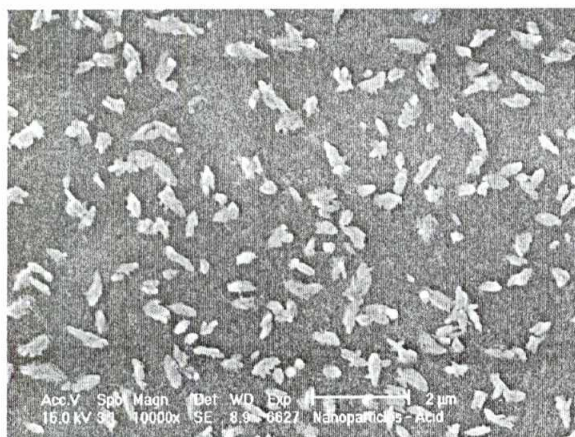

Fig. 11. SEM Image of Nanocellulose prepared by Acid Hydrolysis (Scale bar = 2 μm)

Activity 4. Chemo-mechanical preparation of cellulose nano-fibrils

Among the three processes tried viz., ball milling, pulverization and refining, the fibrillation could be achieved only by the refining process. The average size of control fibre was around 25 microns while that of refined fibres was in the range of 63 - 642 nm. The yield of micro fibrils was 44 percent after 30 passes through lab disc refiner. The total energy consumption was 82 kilowatt-hour per kilogram of cotton fibres for 30 passes. Further size reduction will be tried.

Objective 2: To prepare the polymer nano-cellulose composites and to evaluate their mechanical, barrier and biodegradability attributes.

Activity 1. Preparation of biodegradable polymer nano-cellulose composites

Starch was modified by carboxymethylation and gelatinized along with glycerol. This was casted on the Teflon coated glass plates and dried in vacuum oven for film formation. For nano composites films, the nano cellulose suspension was added along with starch slurry and the film was formed. Two different process conditions were tried for the formation of nano composites films.

Activity 2. Characterization of polymer nano-cellulose composites for mechanical, barrier and biodegradability attributes

Mechanical properties like tensile

strength and elongation at break were analyzed for both control and nano composites films. A tensile strength values of 99 and 103 Mpa and elongation at break of 24 and 26 % were recorded for control and nano composite films, respectively.

CORE AREA IV : UTILISATION OF COTTON PLANT RESIDUES FOR PRODUCTION OF VALUE ADDED PRODUCTS

Determination and Characterisation of Oil and Protein in Bt. Cottonseeds

Sixty Bt. Cotton seed samples pertaining to F1 and F2 generation were procured from J.K. Seeds Co. (Hyderabad), Cotton Research Station (Surat), U.A.S., Dharwad and CICR, Regional Station Coimbatore and evaluated for oil content. Eighteen samples were evaluated for protein content and fatty acid profile as well.

Test results indicated a reduction in oil content in F2 generation seeds belonging to J.K. Seeds Co., while, a reverse trend was noticed in the seed samples of Cotton Research Station (Surat) and UAS, Dharwad. The oil content in F2 generation seeds of these samples was considerably higher as compared to F1 seeds. Further, it is worth noting that the oil content in the Bt cotton seed samples of NAU, Navsari and UAS, Dharwad was unusually, but consistently higher.

No specific trend was noticed in the protein content of F1 and F2 seeds

except in a few F2 samples wherein a slight reduction in protein content was noticed. In general protein content of J. K. Seeds and Cotton Research Station (Surat) was found to be on the lower side. Efforts are being made to understand if the type of protein in Bt. seed has any influence on the oil content in F2 generation.

Externally Funded Project

Preparation of Value Added Products from Cottonseed Meal by Extrusion Cooking

Cottonseeds of Bunny Bt. were procured and delinting and dehulling were carried out. Cottonseed meal was taken and sieved into two fractions. The cottonseed cake samples were prepared from whole cottonseed kernels by passing through expeller for extraction of oil. To preserve the qualities of cottonseed cake only one pass through the expeller was made. These samples were taken and powdered and mixed with cassava flour in the ratios 20:80, 30:70 and 40:60. Moisture stabilization was done by adding water making the moisture content to 16%. The samples were passed through the extrusion cooker. The cooker temperature was kept at 85° C and the die temperature was varied from 150-180° C. The puffing was observed to be less with 40 % cottonseed and the colour grade was observed to be comparable. The 20:80 and 30:70 samples (Meal : Cassava flour) were observed to be comparable in terms of the colour grade and puffing.

Utilisation of Cotton Plant By-produce for Value Added Products (CFC/ICAC/20)

During the year under report cotton stalk collection, chipping and transportation was entrusted to an identified party at Nanded. As much as 500 tonnes of chips were made available to a factory near Nanded.

In an effort to utilise all the available crop residues in the cotton belt, blending trials were undertaken using mulberry stalks and bagasse. The results indicated that boards of acceptable quality could be prepared. Despite identifying rural entrepreneurs to procure cotton stalks from the farmers, chipping them and transporting to the identified board industry, the effort failed due to lack of chipper and tractor by them. In order to overcome this position, we procured them and installed it in a place near Nanded and mobilised the cotton stalk supply. The stalks were chipped and transported to M/s. Godavari Particle Board Industry. About 500 tonnes of chips were supplied at a cost of Rs. 1500/- tone. They needed 1000 tonnes of chips in the coming season. This exercise ensured Rs. 200/- to the farmers towards the biomass alone.

Awareness meets were conducted near Coimbatore and Nagpur to highlight the importance of cotton stalks to the farming community.

Commercial Technology Development for Value Addition to Cotton Plant By-produce (MM1 4.2 of TMC)

RESEARCH ACHIEVEMENTS



Fig. 12. Extruded Product at different Temperatures

Trials on the prevention of fungi elaborating aflatoxin during cottonseed storage indicated that spraying seeds with 1% propionic acid inhibited the fungal growth for a period of six months. One hundred kg trial was extended to one tonne trial and samples withdrawn at monthly intervals indicated a significant reduction in the fungal population. Simultaneously, trials are also underway on spraying microbial consortium made to form propionic acid on vegetable wastes with other enzymes *viz.* pectinases.

CORE AREA V : DEVELOPMENT OF ENTREPRENEURSHIP FOR UTILIZATION OF CIRCOT TECHNOLOGIES

Training, Commercial Testing, Transfer of technology and Consultancy are dealt under this core area. These activities are discussed in detail in Chapters 3, 4, and 5.

Externally Funded Project

Zonal Technology Management and BPD Unit at CIRCOT, Mumbai (National Agricultural Innovation Project, Component 1)

The Indian Council of Agricultural Research under the National Agricultural Innovation Project scheme has set up a Zonal Technology Management and Business Planning & Development (BPD) unit at CIRCOT, Mumbai. BPD is considered as an effective way for fostering the growth of sustainable business endeavour and is expected to provide a gamut of services ranging from incubation facilities such as research support and business planning to business services such as office space, access to information and communication technologies, advice on management, marketing, technical, legal, IPR and financial issues. The BPD

Units are also expected to promote entrepreneurial attitude and raise awareness about the opportunities that the entrepreneurship can bring into the local business environment. These units are intended to develop an institutional system to organise and promote the sharing of information among MSME.

ZTM-BPD-CIRCOT's focus is to create technology-oriented commercially successful business ventures. Initially ZTM-BPDCIRCOT will be concentrating on technologies available with CIRCOT and other ICAR Institutes in the western zone. In the near future, ZTM-BPD-CIRCOT will assist the incubatee's in creating entrepreneurship based on his own idea.

Early stage advice to entrepreneurs/incubatees will be offered as a free service. When ZTM-BPD-CIRCOT is satisfied with the incubatee, the promoter will enter into an agreement with ZTM-BPD-CIRCOT for availing its services on mutually agreed terms and conditions. The incubatees would benefit from the lower cost of resources in the early stage. The form of compensation and the payment mode would be tailored to specific needs and based on individual case.

ZTM-BPD-CIRCOT will be created at Mumbai with a provision to expand in the proposed new Laboratory building coming up in the same premises. ZTM-BPD-CIRCOT will function through off campus facilities both at Nagpur and Coimbatore to promote and utilize

CIRCOT technologies among the textile enterprises available around those regions. ZTM-BPD-CIRCOT will be promoted through various marketing channels like Trade shows, Technical symposia, Technology transfer conferences, Trade association meetings, Professional association contacts and web marketing.

As the ZTM-BPD-CIRCOT will play an important role in the regional development and economy, aggressive marketing efforts will be undertaken to popularize the business planning and development concept. The existing Zonal Institute's contacts and technology transfer channels would be utilized to promote ZTM-BPD-CIRCOT and its services vigorously. It is also proposed to arrange interactive business opportunity workshops with various entrepreneur development cells, Industrial associations, Industrial development/financial corporations, Universities and so on. BPD unit will also network with various technology promotion agencies in India.

ZTM-BPD-CIRCOT will participate in major agricultural exhibitions, workshops and symposia to promote its activities and services in India. A website will be launched exclusively for ZTM-BPD-CIRCOT for the promotion its services. This website would be an interactive type and would also be used for the web marketing of Zonal technologies.

3

Technology Assessed and Transferred

The prime objective of any research organization is to translate the benefits of the research findings to the needy end user. This has to percolate easily and in time without any obstruction.

Scientists at CIRCOT spend most of their time in developing newer technologies in the area of post harvest processing of cotton, eco-friendly finishing of textiles, better utilization of by-product of cotton cultivation; they strive hard to bring to the forefront and popularise them among the end users in many ways. There has been a continuous monitoring of the transferred technologies and processes and a regular upgrading of the already developed innovations so as to provide continued benefit to the users. The Institute maintains a constant liaison with private organizations and entrepreneurs so that their needs are met and at the same time the Institute also generates revenue. This chapter summarises the technologies developed and consultancies offered by the Institute during the reporting year. Attempts were made for popularisation and commercial adoption of viable technologies through Awareness Meets conducted periodically at various places.

Consultancies Undertaken :

- Evaluation of Water Samples for M/s. Hemmopharma Ltd., Mumbai
- Installation of Biogas Plant based on Cotton Dust for M/s. Rasi Tex (I) Pvt. Ltd., Salem, Tamil Nadu
- Evaluation of the Purification Efficacy of the equipment for M/s. Ion Exchange India Ltd.
- Evaluation of Limiting Oxygen Index on Treated Fabric Samples for M/s. Bannari Amman Institute for Technology
- Analysis of Bagasse fraction for M/s. Lignoil Technologies Pvt. Ltd., Mumbai
- Validation of Water Purification System for M/s. Hemmopharma Ltd., Mumbai
- Determination of mechanical properties of orthodontic wires for Dr. D.Y. Patil Dental College & Hospital, Nerul
- Analysis of cotton seed samples for M/s. Carver Technology & Equipment Pvt. Ltd.
- Consultancy in R&D for developing various ginning machines for M/s. Bajaj Steel Industries Ltd., Nagpur.

Patents Granted :

1. Microbial Pretreatment of Polyester Fabric to Improve the Moisture Regain and Wear Comfort
2. Biological Softening of Lignocellulosic Material for Preparing Binderless Board
3. Microbial Degumming of Mulberry Silk
4. Roller Type Cotton Stalk Compacting Machine
5. Miniature Lap Preparation Machine for Yarn Strength Test
6. A Parallelised Yarn Bundle Preparation Machine for Yarn Strength Test
7. A New Enzymatic Process for the Preparation of Absorbent Cotton from Non-spinnable Short Staple Cotton
8. Process for Dyeing of Textiles using Solvent Extracted from Marigold Flower Waste
9. A Biochemical Process for Preparation of Absorbent cotton from Non-spinnable Cottons using Microbial Consortium
10. A Bioenrichment of Cattle Feed for Better Digestibility
11. A Method for the Preparation of Cellulose Powder from Crop residues
12. Degumming of Decorticated Ramie Fibres by a Biochemical Method

Commercial Testing:

Nearly 9000 samples were tested during the year under report at the Headquarters Mumbai, GTC, Nagpur and other Regional stations at Coimbatore, Guntur, Sirsa, Surat and Dharwad (Table 9). The Total revenue generated through commercial testing was around Rs. 21.5 lakh.

TABLE 9 : NUMBER OF SAMPLES TESTED AND REVENUE GENERATED

Name	No. of samples	Amount (Rs.) in Lakhs
Headquarters (Mumbai)	6084	1441238
Coimbatore	310	50725
Guntur	1785	53550
Dharwad	380	79387
Surat	482	98750
GTC, Nagpur	630	54712
Sirsa	275	380507
Total	9946	21,58,869

4

Education and Training

Education

The Institute has been permanently recognized by the University of Mumbai for pursuing Post graduation in Physics, Physical Chemistry, Organic Chemistry, Bio Physics and Microbiology, Ph.D in Physics and Textile Manufacture, Biophysics and Microbiology under Section 88 of the Maharashtra Universities Act 1994 and amended by the Maharashtra Universities (amendment and continuance) Act 2000. The Institute has two guides for M.Sc. and four for Ph.D.

During the current year, two students enrolled for M.Sc. while one student has submitted thesis for Ph.D. Further, the Institute has been recognised as a guiding centre for M.Sc. and Ph.D. courses in Home Science (Textiles) of the SNDT Womens' University, Mumbai. At present, one student is availing this facility to pursue his work for the award of Ph.D degree.

Training

CIRCOT conducts regular training programmes on cotton quality evaluation for personnel drawn from cotton trade and industry. The Ginning Training Centre at Nagpur conducts training courses for fitters and other

workers in ginning industry on appropriate technologies in ginning for the production of clean quality cotton and on the maintenance aspects of ginning and allied machines.

The Institute organises special training courses on the operation of High Volume Instrument (HVI) and Advanced Fibre Information System (AFIS) and interpretation of test results obtained from these state-of-the-art facilities at the Headquarters. All training courses comprise informative lectures and a series of practical demonstrations along with visits to the Textile/ Ginning and Pressing industries to get practical knowledge on the respective subject. Course material in the form of a book containing details of test methods, statistical interpretations of results, etc. is provided to the trainees. The Institute also conducts special training programmes to personnel sponsored from industry on specified topics depending on demand.

(a) Training on Quality Evaluation of Textile Fibres for Personnel from Trade and Textile Industry

During the period under report, 74 sponsored personnel were trained under the following different categories.

Type of Training	No. of Trainees	No. of Batches
Training to Egyptians	4	1
HVI & AFIS course	11	1
One week course	26	1
SPL Two week course	06	1
Three Day Spl. course	27	1
Total	74	6

(b) Training on Ginning and Baling for Fitters, Operators and Managers from Ginning Industry

At the Ginning Training Centre at Nagpur, regular training programmes are conducted for the benefit of gin operators and management staff on various aspects of ginning and material handling. During the reporting period,

training was imparted to 119 persons in eight batches. At every training programme emphasis was given on the need to produce contaminant free clean cotton for use by the industry.

(c) One Week Refresher Course

A One Week refresher course on **Quality Testing of Cotton Textile, By-product and General Institutional Activities** was conducted from September 29 to October 4, 2008. Dr. R.P. Nachane, Principal Scientist & Head, QEID was the Convener and Shri Chitranayak, Scientist was the Course Co-ordinator. Ten Technical personnel and one Scientist underwent training. The participants were awarded certificates after successful completion of the course.



Dr. S. Sreenivasan, Director giving away certificate to Shri S.N. Hedau, one of the Technical Officers after completing the Refresher Course

5

Linkages and Collaboration

CIRCOT does not have an agricultural farm attached to it. However, the Regional Quality Evaluation units of CIRCOT located in major cotton growing areas and situated within the agricultural university premises serve as extension units for the Institute. Scientists of CIRCOT constantly interact with the scientists of agricultural universities and provide inputs on the technological aspects of cotton at different stages of crop development, post-harvest technology operations, etc. and thereby help in improving the quality of strains as per the requirement of the industry. The regional units of CIRCOT are used as windows for promoting CIRCOT technologies for efficient utilisation of cotton fibre, crop by-products and other agro-waste materials. The Institute has been providing technological support to breeders from private seed industry for development of Bt. cottons by providing data on the spinnability, fibre quality, oil content, etc. through contract/consultancy research. CIRCOT has established linkage with an NGO organisation *Varshad Vikas Seva Pratistan*, Akola to carry out field trials on the Low Cost Sliver Machine developed by the Institute and upgradation of this machine is also

underway. It has also established collaboration with the Indian Rubber Manufacturers' Research Association (IRMRA), Water Technology Centre for Eastern Region, (WTCER) (ICAR) and a reputed private manufacturer of technical textiles viz. M/s. Kusumgar Corporate under the National Agricultural Innovation Project (NAIP). Under the newly sanctioned NAIP project **Zonal Technology Management and BPD Unit at CIRCOT**, a website has also been designed to cater to the needs of the end users by showcasing the various technologies and processes developed by the Institute. This project is also expected to go a long way in assessing the market demand for various new innovations developed by the Institute.

Technology extension and out-reach activities are carried out through participation of the Institute in various exhibitions, *Kisan melas*, etc. conducted in different parts of the country. Besides, the Institute also undertakes collaborative research programmes with private sector, other research bodies connected with both state and central governments in post harvest technology and value addition to cotton and other natural fibres.

The Director and Scientists of CIRCOT serve as resource personnel in various committees constituted by the Bureau of Indian Standards for cotton and textiles and they participate in various seminars, symposia, conferences, etc. organised within the country that constitute a platform for the exchange of their knowledge and expertise in different fields of research. The Director and many scientists are members of advisory panels of institutions like ATIRA, BTRA, SITRA, CCI, ICMF, CAI, etc. Many of the Scientists also act as experts in several committees like Technology Development Board (TDB) under the Department of Science and Technology (DST) for assessment of proposals for setting up / expanding cotton processing industry.

Many scientists are invited to give lectures and to participate in discussions related to cotton in particular and natural fibres in general organised by other institutions. They also publish their research findings both in scientific and popular journals apart from participating in seminars, conferences and exhibitions displaying technologies and processes developed or improved by the Institute.

Publications of research findings in national and international journals constitute an important mode of extension activity. Publications in popular journals help to bring research closer to the user community.

The Institute conducts regular training courses on Cotton Quality Evaluation including elementary statistics applicable to textile testing for the sponsored personnel from the cotton trade and industry while at the Ginning Training Centre of CIRCOT at Nagpur both theoretical and practical training skills are imparted on different aspects of ginning and maintenance of ginning machines. A hostel with facilities to accommodate about 20 trainees is presently available at GTC, Nagpur.

Another important form of extension activity is supply of information in response to various queries received on cotton fibre, yarn and fabric, consultancy services, contract research and bringing out regular pamphlets on various processes developed and innovations brought about by the Institute for use by different stake holders.

Technical Queries: Queries from private organisations, semi-government, state and central government departments were received and replies sent promptly. Information on various technologies and devices developed by CIRCOT, instruments designed, methods of tests standardised for cotton fibre, yarn and fabric, quality levels of different cotton varieties, by-products and agro-waste utilisation, etc. were supplied to interested end users on numerous occasions.

LINKAGES AND COLLABORATION

Commercial Testing: The Test House at CIRCOT had received a number of samples of fibre, yarn, fabric and miscellaneous items for tests on payment basis from industries, textile and other educational institutes, and state government bodies.

The details of number of commercial samples tested at CIRCOT, Mumbai during the period 2008-09 together with samples tested in the recent past are presented in Table 10.

TABLE 10 : DETAILS ON SAMPLES TESTED AT CIRCOT

Sr. No.	Type of Tests	Average during X Plan (2002-03 to 2006-07)	XI Plan	
			2007-08	2008-09
1.	Ginning, Fibre, Trash Content and Spinning	8438	1961	5253
2.	Yarn	254	160	35
3.	Fabric	445	418	616
4.	Miscellaneous	516	332	180
	Total	9653	2871	6084

Besides routine tests, some special tests were also carried out on samples received from various organisations

against payment of fees. Highlights of these tests are given below in a tabular form.

Sr. No.	Party's Name	Test
1	M/s. Amardeep Udyog, Mumbai	Paper testing
2	M/s. Anabond Ltd., Chennai Activity	Anti Microbiological
3	M/s. Arch Pharma, Mumbai	X-Ray Diffraction Analysis
4	B.N. Borodkar College of Science, Thane Spectroscopy	Atomic Absorption
5	BARC, Mumbai Microscopy	Scanning Electron
6	M/s. Bombay Dyeing, Patalganga	Fibre to Fibre Friction
7	M/s. Cadilal Health Care, Thane Microscopy	Scanning Electron
8	M/s. Croda Chemicals, Navi Mumbai	Surface Tension
9	M/s. Delkon Textiles Pvt. Ltd. New Delhi	Limiting Oxygen Index
10	M/s. Fine Organic, Mumbai Microscopy	Scanning Electron

Sr. No.	Party's Name	Test
11	M/s. Indo Rama Synthetics (I) Ltd., Mumbai	Fibre to Fibre Friction
12	Institute of Science, Colaba, Mumbai Microscopy	Scanning Electron
13	M/s. Ion Exchange, Navi Mumbai	Limiting Oxygen Index
14	M/s. MEP Cotton, Gondal	Celulose Yield
15	Naval Research Lab, Ambernath	X-Ray Diffraction Analysis
16	M/s. Reliance, Mumbai	X-Ray Diffraction Analysis
17	M/s. Shraddha Analytical Services, Mumbai	X-Ray Diffraction Analysis
18	Textile and Engineering Institute, Ichalkarangi	Scanning Electron Microscopy
19	UICT, Mumbai	Scanning Electron Microscopy
20	UICT, Mumbai	Total Gravimetric Analysis
21	UICT, Mumbai	X-Ray Diffraction Analysis

Exhibition/Publicity :

CIRCOT participated in various exhibitions displaying the technologies developed and those available for commercialisation. Large number of entrepreneurs and farmers evinced keen interest in the technologies.

Exhibition :

- Arranged an exhibition at CIRCOT,

Mumbai during the visit of Shri Sharad Pawar, Hon'ble Union Minister of Agriculture, New Delhi on November 1, 2008.

- Participated in the exhibition in **Pusa Krishi Vigyan Mela** organized by ICAR at IARI, New Delhi from February 23-26, 2009.

LINKAGES AND COLLABORATION

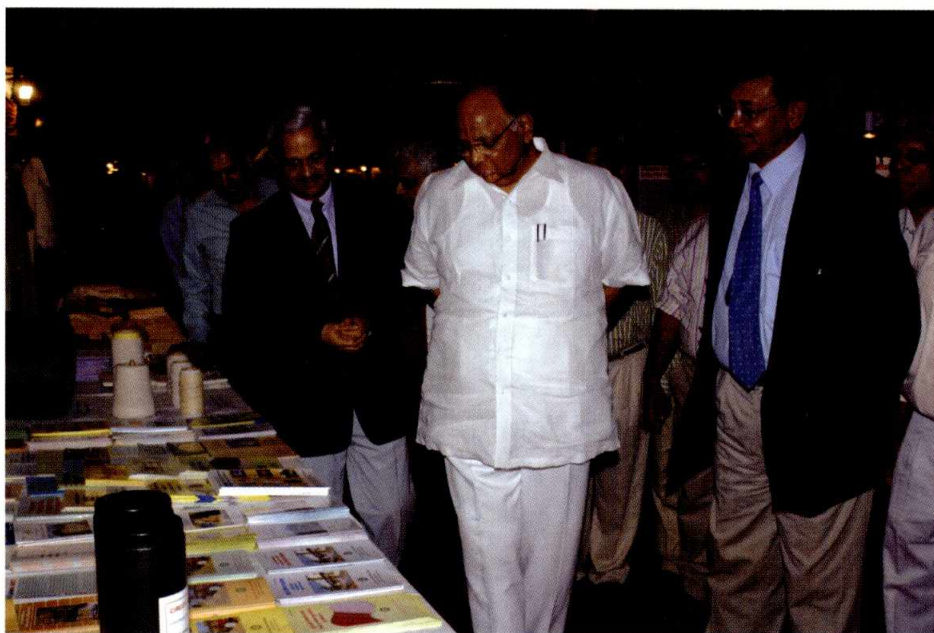

Shri Sharad Pawar, Hon. Union of Minister of Agriculture, Consumer Affairs, Food and Public Distribution along with Dr. Mangala Rai, Secretary, DARE and D.G., ICAR with Dr. S. Sreenivasan, Director, CIRCOT at the exhibition organised at the Institute on the occasion of the Foundation Stone Laying Ceremony of the Proposed Yaswanthrao Chavan Building at CIRCOT



Shri G.B. Hadge, Technical Officer T-6 explaining the various Technologies and Processes developed by the Institute and Shri Ashok Kumar Bharimalla, Scientist in the Stall at Pusa Krishi Vigyan Mela at New Delhi from February 23-26, 2009.

6

Publications

A. Annual Report

Annual Report of the Central Institute for Research on Cotton Technology for the year 2007-2008.

B. Research Publications (CIRCOT Publications – New Series)

1. Vigneshwaran, N. - *Nanotechnology in Extreme Environments* Nano-The Magazine for Small Science, Issue 9, pp. 32-33, December 2008.
2. Pathak, D., Gill, M.S., Parkash, R., Hasan, H. and Khosla, G. - *Genetic Divergence Analysis based on Fibre and Seed Characters in Desi Cotton (G. arboreum L.)*, *SKUAST J. Res.* Vol. 10, pp. 236-41, 2008.
3. Tuteja, O. P., Mehta, A. and Hasan, H. - *Impact of Plant Densities and Nitrogen Level on Seed Cotton Yield and Fibre Quality on Promising Hybrids of Gossypium hirsutum L.*, *J. Indian Soc. Cotton Improv.* Vol. 33, No. 1, pp. 54-56, 2008.
4. Sujatha R. Kawlekar, Usha Mukundan - *Dyeing Cotton with Natural Colourant – Marigold*, *Textile Trends*, Vol. LI, No. 11, pp. 33 – 38, 2009.
5. Meena, R.A., Monga, D., Kumar, R. and Hasan, H. - *Screening of American Cotton (Gossypium hirsutum L.) and Desi Cotton (Gossypium arboreum) for Fibre Quality Traits, Seed Cotton Yield and Important Yield Components* published in *Indian J. Plant Genet. Resources*, Vol. 19, No. 1, pp. 122-24. (Late Publication)

C. Popular Articles

1. Chitranayak – *Kapas Utpadan Mein BharatNe America Ko Pachhada*, *Kheti Duniya*, Vol. 21, P. 1, Hindi Ka Krishi Saptahik.
2. Chitranayak – *Mahatta Hindi Ki*, *Raj Bhasha Rashmi*, Vol. 1, January – March, pp. 20 – 22, Cotton Corporation of India, Kapas Bhavan, CBD Belapur, Navi Mumbai, 2008.

D. Other Publications

1. Vigneshwaran, N., Mhaske, S.T. - A Status Report on Nanocellulose and its Bio-nanocomposites
2. HPTLC Fingerprinting : A Technique for Characterisation of Natural Dyes.

PUBLICATIONS

3. CIRCOT News – Vol. 10 (1), October 2007 to March 2008 and Vol. 10 (2), April 2008 to September 2008.
4. CIRCOT Ginning Bulletin – Vol. 8 (2), October 2007 to March 2008 and Vol. 9(1), April 2008 to September 2008.
5. Shweth Sarinika, Vol. 24, January to March 2008 and Vol. 25, April – September 2008.
6. Handbook of Methods of Tests for Cotton Fibres, Yarn and Fabrics : Part 3 : Chemical Tests, Identification and Estimation of Fibres in Textile Materials, Biological Tests, Eco testing and Testing of Paper and Paper Boards (Ed.) V. Sundaram, K.R. Krishna Iyer, S. Sreenivasan, pp. 124., 2008.
7. Cotton Ginning – Technology, Trouble Shooting and Maintenance (Ed.) V.G. Arude, S.K. Shukla, T.S. Manojkumar, pp. 241, July 2008.
8. *Kendriya Kapas Prowdhyogiki Anusandhan Sansthan Mein Hindi Karyanvayan Ke Badhte Charan*
9. Vigneshwaran, N., Varadarajan, P.V. and Balasubramanya, R.H. - *Application of Metallic Nanoparticles in Textiles*, Chapter 14, pp. 541-558, in *Nanomaterials for the Life Sciences Vol. 1 : Metallic Nanomaterials* (Ed.) Challa S. S. R. Kumar, WILEY-VCH Verlag GmbH & Co. KGaA, Weinheim, 571 pp., 2009.

E. Papers Presented at Seminar / Conferences, etc.

The following papers were published at the International Conference on the Advances in Textiles, Machinery, Nonwoven & Technical Textiles ATNT 2008 organised by Avinashilingam University for Women, Coimbatore, India, and The Institute of Environmental and Human Health, Textile Tech University, USA held at Coimbatore from July 14 – 16, 2008.

1. Chattopadhyay, S.K. and Chaphekar A. K. - *Cotton Based Technical Yarns and their Manufacture for Diversified Applications.*
2. Mahangade, R.R., Verma, J.K., Varadarajan, P.V. and Bosco, H. - *New Dyeing Techniques for Enhancing Colour Strength and Fastness Properties of Cotton Fabric Dyed with Natural Dyes.*
3. Nachane, R.P., Nair, A.U. and Patwardhan, B. - *Comparative Study of Physical Properties of Some Cottons.*
4. Sreenivasan, S. - *Quality Profile of Indian Cotton for Diverse Applications.*
5. Chattopadhyay, S.K., Dey, S.K., Bindu, V. and Chaphekar, A. - *Value Added Knits from Ramie-Cotton Blended Yarns Spun using Short Staple (Cotton) Spinning System*

- presented at the International Conference on Flax and other Bast Plants organized by FAO / ESCORENA NETWORK held at Saskatoon, Canada, from July 21 to 24, 2008.
6. Chattopadhyay S. K., and Bharimalla A. K. – *Design Criteria in Developing Fabric Reinforcement for Geo (Rubber) Check Dam* presented in the 10th Annual General Body Meeting (AGM), organised by Indian Fibre Society (IFS), held at CIRCOT, Mumbai on September 27, 2008.
 7. Chattopadhyay S. K., and Sreenivasan S. - *Advances in Production Technology in Agrotextiles* presented at the Seminar on Agrotextiles; Emerging Opportunities, organized by Federation of Indian Chambers of Commerce and Industry (FICCI), and SASMIRA held on October 1, 2008 at Mumbai.
 8. Pathak, D., Gill, M.S., Hasan, H. and Parkash, R. – *Evaluation and Estimation of Genetic Parameters of Asiatic Cotton Germplasm for Fibre and Seed Characters*, presented at the National Symposium on New Biology in Agriculture held from November 7 to 8, 2008 at Chandigarh.
 9. Talukdar M. K., Chattopadhyay S. K. and Pal B. P. - *Design and Development of Fabric Substrate for Flexible Rubber Dams* presented at the International Conference on Technical Textiles and Nonwovens, organized by IIT Delhi from November 11 to 13, 2008 at New Delhi.
 10. Wani, P.S., Kambli, N.D. and Balasubramanya, R.H. - *Preparation of Absorbent Cotton from Short Staple Cotton using Microbial Consortium – An Eco-friendly Approach* presented at the 49th Annual Conference of the Association of Microbiologists of India held on November 18 – 20, 2008 at New Delhi.
 11. Wavhal, S.D. and Balasubramanya, R.H. - *Microbial Treatment of Polyester Fabrics for Enhancing the Moisture Regain and Improving the Wear Comfort Properties* presented at the 49th Annual Conference of the Association of Microbiologists of India held on November 18 – 20, 2008 at New Delhi.
 12. Sreenivasan, S. – *Fibre Quality Assessment by using the HVI and its Relevance to Cotton Trade and Industry* : Presented at the ISBA Trilateral Workshop, CICR, Nagpur, November 29, 2008.
 13. Sreenivasan, S. and Balasubramanya, R.H. – *Value addition to By-products in Plantation Crops* Presented at the PLACROSYM XVIII, NRCC, Puthur, December 12, 2008.

PUBLICATIONS

14. Chattopadhyay, S.K. – *Newer Developments in Production of Textile Reinforcements for Rubber* presented at the 20th Rubber Conference of the Indian Rubber Manufacturers Research Association (IRMRA) held at Thane from December 19 to 20, 2008.
15. Arude, V.G. and Manojkumar, T.S. – *Evaluation of Vibrations of Ginning and Pressing Machinery in Cotton Ginneries* presented at the International Ergonomics Conference 2008 HWWE held on December 22 – 24, 2008 at Pune.
16. Bharimalla A.K. and Chattopadhyay S.K. - *Design and Development of Geo-check Dam (Rubber Dam) for Watershed to Control Soil Erosion and Conservation of Soils of Hilly Region* in the 2nd National Convention of Agricultural Engineers (NCAE 2009), held at CSK HPKV, Palampur on January 20-21, 2009.
17. Vivekanandan, M.V., Sheela Raj, Sreenivasan, S. and Nachane, R.P. - *Parameters Affecting Warm-Cool Feeling in Denim Fabrics* presented at the 50th Joint Technological Conference held at ATIRA, Ahmedabad on March 4 and 5, 2009.
18. Jain, P., Gayal, S. G. – *Fluorescence Spectroscopic Study of Cellulase Enzyme as relevant to Catalytic Activity and Hydrolysis of Crystalline Cellulosic Substrate* presented at Florescence 2009 held at Tata Institute of Fundamental Research, Mumbai from March 16 to 19, 2009.

List of On-Going Projects During 2008-2009

CORE AREA I : IMPROVEMENT IN GINNING OF COTTON

Sl. No.	Name of the Project	Principal Investigator	Associates
1.	Development of techno-economically Viable Cottonseed Delinting Process to Recover Linters	Dr. P. G. Patil	Dr. K.M. Paralikar Dr. A.J. Shaikh
2.	Influence of Storing Conditions on Bale Quality	Dr. S.B. Jadhav	Dr. P.G. Patil Shri S.K. Shukla Dr. S.G. Gayal
3.	The Performance Evaluation of Cyclones used in Modern Ginneries	Shri S. K. Shukla	Shri V.G. Arude Dr. T.S. Manojkumar Smt. Jyoti Mintu Nath
4.	Design and Development of Barcode Technology for Tagging Cotton Bales	Smt. Jyoti Mintu Nath	Shri V.G. Arude Shri S. K. Shukla
5.	Design and Development of an Axial Flow Cotton Pre-cleaner	Shri V.G. Arude	Shri S.K. Shukla Dr. T.S. Manojkumar
6.	Design and Development of Pneumatic Loading System for Double Roller Gin	Shri A.K. Bharimalla	Dr. S.B. Jadhav Shri R.S. Prabhudesai

CORE AREA II : IMPROVEMENT AND QUALITY EVALUATION OF FIBRES, YARN AND FABRIC

Sl. No.	Name of the Project	Principal Investigator	Associates
1.	Evaluation of the Quality of Cotton Samples under the All India Co-ordinated Cotton Improvement Project	Director	Scientists and Technical Personnel
2.	Evaluation of Quality of Major Trade Varieties Grown in Different Parts of the Country	Director	Scientists and Technical Personnel
3.	Evaluation of Quality of Standard Varieties of Indian Cotton	Director	Scientists and Technical Personnel

Sl. No.	Name of the Project	Principal Investigator	Associates
4.	Demand Model for the Consumption of Cotton Fibre in Textile Sector	Shri C. Sundaramoorthy	Dr. S.K. Chattopadhyay Dr. C.D. Ravindran Dr. K.M. Paralikar
5.	Fabrication and Evaluation of an Instrument for Measuring Electrical Properties of Textile Materials	Shri Chitranayak	Dr. R.P. Nachane Dr. D.N. Makwana Shri Achchhelal Yadav Shri Virendra Prasad
6.	Structure-Property Relationships in DREF Friction Spun Yarns	Shri Achchhelal Yadav	Dr. S.K. Chattopadhyay Shri R.K. Jadhav
7.	Design and Development of Rotating Flat for CIRCOT Mini Card	Shri P.S. Deshmukh	Dr. S.K. Chattopadhyay Shri R.K. Jadhav Shri D.U. Kamble

**CORE AREA III : FINISHING AND DYEING OF COTTON WITH
NATURAL AND ENVIRONMENT FRIENDLY AGENTS**

Sl. No.	Name of the Project	Principal Investigator	Associates
1.	Production of Xylanase by <i>Aspergillus niger</i> sp. through solid State Fermentation and its Application to Lignocellulosic Materials	Dr. S.G. Gayal	Dr. R.H. Balasubramanya Kum. C.P.D' Souza
2.	DP Finishing of Dyed Fabric	Shri R.M. Gurjar	Shri V. Prasad Shri R.R. Chhagani Dr. (Smt.) Sheela Raj Shri S. Sekar
3.	Production of Titanium Dioxide Nanoparticles and their Application in Cotton Textiles for Antibacterial and Self Cleansing Properties	Shri Virendra Prasad	Dr. N. Vigneshwaran Dr. A.J. Shaikh Dr. Sujata Kawlekar
4.	Application of Zinc Oxide Nanoparticles for Imparting different Functional Finishes to Cotton Textiles	Dr. N. Vigneshwaran	Shri V. Prasad Shri Achchhelal Yadav Shri C. Sundaramoorthy
5.	Eco friendly Pre and Post Processing of Fabrics Prepared from Organic Cotton and Finishing with Chitosan	Dr. S.G. Gayal	Dr. (Smt.) Sujatha Saxena Dr. R.P. Nachane Kum. C.P.D'Souza
6.	Development of Protective Clothing for Agricultural Pesticide Spraying Operations	Dr. (Smt.) Sujatha Saxena	Dr. R.P. Nachane Dr. P.V. Varadarajan Shri Chitra Nayak

**CORE AREA IV : UTILISATION OF COTTON PLANT RESIDUES FOR
PRODUCTION OF VALUE ADDED PRODUCTS**

Sl. No.	Name of the Project	Principal Investigator	Associates
1.	Determination and Characterisation of Oil and Protein in Bt. Cottonseeds	Dr. A.J. Shaikh	Dr. R.H. Balasubramanya Smt. Prema Nair Dr. (Smt.) Sudha Tiwari Smt. N.M. Ashtaputre

EXTERNALLY FUNDED PROJECTS

Sl. No.	Name of the Project	Funding Agency	Principal Investigator	Associates
1.	Utilisation of Cotton Plant By-produce for Value added Products	CFC, Netherlands	Dr. R.H. Balasubramanya	Dr. A.J. Shaikh Dr. K.M. Paralikar Dr. P.V. Varadarajan Dr. R.M. Gurjar Dr. P.G. Patil Dr. Manoj Kumar Shri S.K. Shukla Shri V.G. Arude
2.	Quality Evaluation of Cotton Fibre	MMA 4.1 of TMC – MM1)	Dr. R.P. Nachane	-
3	Commercial Technology Development for Value Addition to Cotton Plant By-produce (MM1 4.2 of TMC)	MMF 4.2 of TMC – MM1)	Dr. R.H. Balasubramanya	Dr. R.M. Gurjar Dr. A.J. Shaikh Dr. P.V. Varadarajan
4.	A Value Chain for Cotton Fibres, Seed, Stalks: An Innovation for Higher Economic Returns to Farmers and Allied Stake Holders	National Agricultural Innovation Project (Component 2)	Dr. R.P. Nachane	Dr. K.M. Paralikar Dr. R.H. Balasubramanya Dr. P.V. Varadarajan Dr. A.J. Shaikh Dr. S.G. Gayal Shri R.M. Gurjar Dr. D.N. Makwana Shri D.V. Mhadgut Dr. P.G. Patil Dr. S. Venkatakrishnan Shri Ram Parkash
5.	Preparation of Value Added Products from Cottonseed Meal by Extrusion Cooking	Inter-Institutional Project between CIRCOT and CPCRI, Thiruvananthapuram	Dr. T.S. Manojkumar	Shri V.G. Arude Dr. (Smt.) A. Kathe Dr. (Smt.) Sudha Tiwari

LIST OF ON-GOING PROJECTS DURING 2008-2009

Sl. No.	Name of the Project	Funding Agency	Principal Investigator	Associates
6.	Design and Development of Rubber Dams for Watersheds	National Agricultural Innovation Project (Component 4)	Dr. S.K. Chattopadhyay	Dr. C.D. Ravindran Shri A.K. Bharimalla Shri A. Yadav
7.	A Value Chain on Banana Pseudostem for Fibres and other Value Added Products	National Agricultural Innovation Project (Component 2)	Dr. A.J. Shaikh	Dr. R.H. Balasubramanya Dr. R.P. Nachane Shri R. M. Gurjar
8.	A Value Chain for Coconut Fibre and its By-products : Manufacture of Diversified Products of Higher Value and Better Marketability to Enhance the Economic Returns of Farmers	National Agricultural Innovation Project (Component 4)	Dr. S.K. Chattopadhyay	Shri Ashok Kumar Bharimalla Shri C. Sundaramoorthy
9.	Synthesis and Characterisation of Nano-cellulose and its Application in Biodegradable Polymer Composites to Enhance their Performance	National Agricultural Innovation Project (Component 4)	Dr. N. Vigneswaran	Dr. R.H. Balasubramanya Dr. R.P. Nachane Dr. A.J. Shaikh Dr. S.G. Gayal Shri Ashok Kumar Bharimalla Shri Achchhelal Yadav
10.	Zonal Technology Management and BPD Unit at CIRCOT, Mumbai	National Agricultural Innovation Project (Component 1)	Dr. N. Shanmugam	Dr. P. V. Varadarajan Dr. T.S. Manojkumar Dr. S. Venkatakrisnan

8

SRC, RAC and Management Committee

Institute Research Council Meetings

The **One Hundred and Eighth Institute Research Council** meeting of CIRCOT was held at the Committee Room on May 2 and 3, 2008 to discuss in detail about the progress made in each of the different projects under various Core Areas during the period from April 2007 to March 2008. The following new proposals were approved in the two core areas mentioned below:

Core Area I : Improvement in Ginning of Cotton

1. Design and Development of an Axial

Flow Cotton Pre-cleaner

2. Preparation of Value Added Products from cottonseed Meal by Extrusion Cooking

Core Area III : Finishing and Dyeing of Cotton with Natural and Environment Friendly Agents

1. Ecofriendly Pre and Post Processing of Fabrics Prepared from Organic Cotton and Finishing with Chitosan
2. Development of Protective Clothing for Agricultural Spraying Operations



Discussion during the Institute Research Council Meeting on May 2, 2008

A Half-Yearly Institute Research Council Meeting was held on November 14 and 15, 2008 in which discussions were held on the progress of research projects carried out during April to September 2008. Dr. S. Sreenivasan, Director was in the Chair and all HODs and Scientists attended all the sessions. Technical Officers of respective divisions attended the sessions, relevant for each one of them.

The following new proposals were approved:

Core Area I : Improvement in Ginning of Cotton

1. Design and Development of Pneumatic Roller Loading System for Double Roller Gin

Research Advisory Committee Meeting

The Fourteenth and Fifteenth Meeting of RAC was held on April 15 – 16, 2008 and March 21, 2009 respectively. This meeting was presided by Dr. Anwar Alam, Chairman, RAC and Vice Chancellor, Sher-e-Kashmir University of Agricultural Sciences and Technology. The Heads of Divisions presented the progress of research in their respective divisions. This was followed by a detailed discussion and some of the suggestions made by the members are reproduced below meeting-wise:

Fourteenth Meeting:

- A project on quality evaluation of

fibres on the basis of demand and supply to the industry to be taken up.

- Analysis of the available fibre quality data on Trade and Standard varieties may be carried out to find out how the varieties fared over the years.
- Human subjective comfort characters may be analysed along with other objective quality parameters of fabric.
- Expected output of the project to be included in the progress report and presentation.
- A study on retting of banana fibres to improve the quality of fibres to be pursued vigorously and apparel fabrics to be attempted to.
- Economic viability of the products and processes to be highlighted.
- Efforts to develop specialised nano finishing on fabrics and paper may be carried out.
- Industrial partners to be identified in transferring the technologies developed.
- With the recent trend of organic farming, composting of cotton stalks may be tried.
- Efforts may be made to commercialise technologies developed in organic dyes.

- Natural dyes in nano form to be attempted.

Fifteenth Meeting :

- R&D activity in knitting and knit wear is not visible although fairly good infra-structure has been created in the Institute. After looking into the consumer preferences some research projects need to be initiated in this area.
- Research work on wool – cotton blending has to be strengthened.
- Work on comfort properties of apparel fabrics needs to be looked afresh.
- While developing Bt. cotton, breeders should take care that the quality of the cotton is not adversely affected.
- Seed cotton to be cleaned in the village itself, ginned and the lint transported to pressing industries. CIRCOT to take up work in this area.
- Reports presented need to give a little background information, objectives and techno-economic analysis of the project so that members can interact in a better manner.
- Modernisation of ginning industry in the country and the role played by the Institute in this regard needs to be highlighted.
- NAIP projects need to bring out clearly the innovations made and the likely benefits for farmers and other stake holders.
- Chitosan is an expensive raw material and not available commercially and hence its production is worth attempting.
- As the regulatory process for release of Bt. cottons does not seem to consider fibre quality as one of the criteria, CIRCOT should take a lead role in curbing the release of those Bt. varieties which do not satisfy fibre quality norms.
- An attempt should be made to ascertain the demand as well as the quality aspect of *desi* cottons preferred by the industry.
- Identify cotton varieties that yield high percentage of oil. Try to find out if any relationship exists between the protein, gossypol and oil content.
- CIRCOT should carry out research work in the area of moisture content in bales and should develop standards.
- Application of cotton for the preparation of technical textiles and non-wovens needs to be attempted.
- Attempts to be made for the

SRC, RAC AND MANAGEMENT COMMITTEE

preparation of multi count / multislab yarns.

- The institute should organize brain storming sessions to generate new ideas.
- As the institute has undertaken a lot of R&D work in microbiological applications, more microbiologists need to be recruited.
- In the light of Zonal Technology

Management and BPD Unit programmes under NAIP project, the role of Transfer of Technology division needs to be looked afresh. The division needs to be reorganised.

- Ginning Training Centre to be brought preferably under the Mechanical Processing Division to allow scientists in TT division to concentrate more on the transfer of technology.

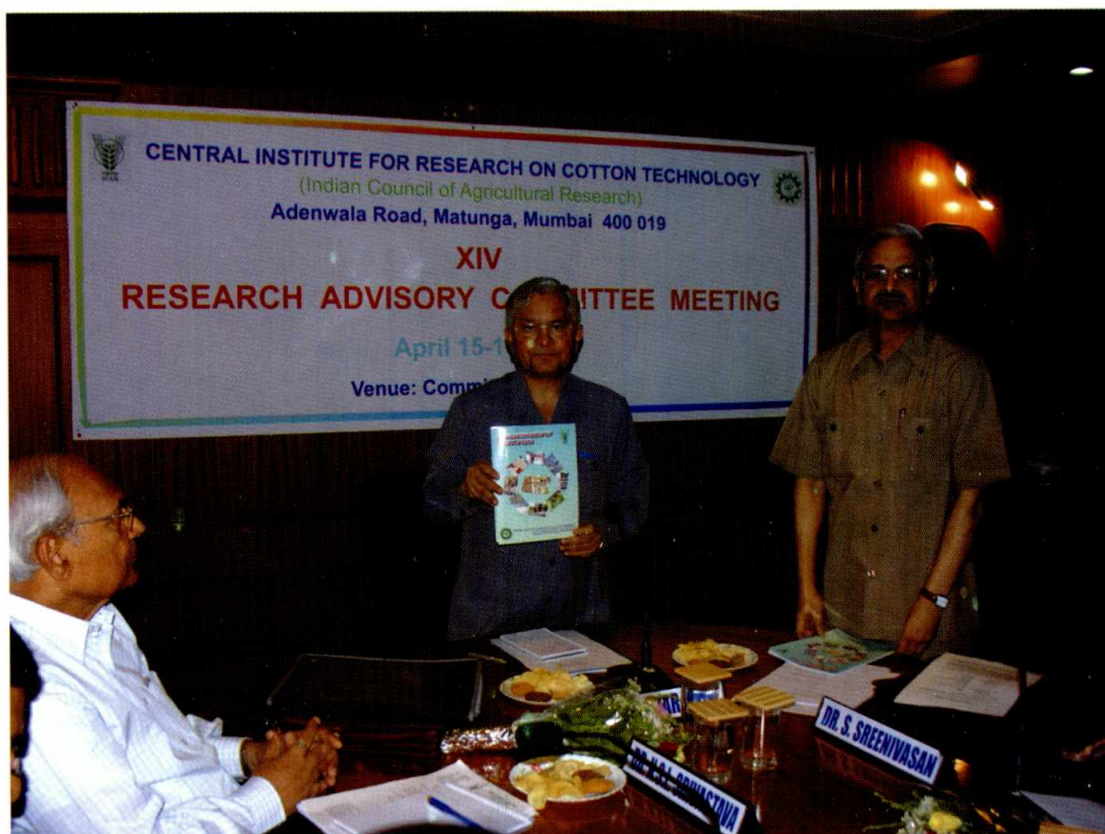

*Dr. Anwar Alam, Chairman, RAC releasing the book-let on **Achievements of the X Plan***

Management Committee Meeting

The Sixty-sixth meeting of the Institute Management Committee was held on March 3, 2009. Regular items like confirmation of minutes of the previous meeting, action taken on the recommendations of the previous meeting, progress of research works, report on Official Language

Implementation, filling up of vacant post of spinning operatives in Mechanical Processing Division, were discussed in the meeting. Another important point of discussion was on the QRT Report of the Institute submitted by Dr. V. Subramaniam, Chairman, QRT. IMC gave its inputs for incorporation in the report.



Sixty-sixth meeting of the Institute Management Committee in Progress

Participation of Scientists/Technical Personnel in Conferences, Meetings, Workshops, Symposia, etc.

Director, Scientists and Technical Personnel of CIRCOT participated in the following scientific and technical conferences besides meetings connected with the work of this Institute.

Sr. No.	Meetings / Conferences / Seminars / Symposia, etc.	Place	Date	Participants
1.	Intellectual Property Rights and World Trade Organisation Related Issues	Hyderabad	28-04-2008 to 02-05-2008	Dr.(Smt.)Sujatha Saxena
2.	FICCI Global Seminar on Technical Textiles	New Delhi	22-04-2008	Dr. A.J. Shaikh
3.	Seminar on Rajbhasha	Goa	02-05-2008 and 03-05-2008	Shri Chitranayak Smt. K.R. Joshi
4.	Web Innovation	Mumbai	08-05-2008	Shri D. Radha- krishnamurthy
5.	Management Development Programme	Hyderabad	16-06-2008 to 20-06-2008	Dr. D.N. Makwana
6.	Advances in Textiles, Machinery, Nonwoven & Technical Textiles ATNT 2008	Coimbatore	14-07-2008 to 16-07-2008	Dr. R.P. Nachane Dr. S.K. Chattopadhyay Dr. P.V. Varadarajan Dr. S. Venkatakrisnan Shri A.K. Chaphekar Shri R.R. Mahangade
7.	Uncertainty Measurements in Chemical Testing	Pune	31-07-2008 and 01-08-2008	Dr. (Smt). S.R. Kawlekar Shri R.S. Narkar
8.	National Seminar on Analytical Chemistry - Good Industrial and Laboratory Practices and Total Quality Management	Mumbai	22-08-2008 and 23-08-2008	Dr. Sujatha Saxena
9.	Management Development Programme on Performance Assessment of Agricultural Research Organisations	Hyderabad	16-09-2008 and 20-09-2008	Dr. S.K. Chattopadhyay Shri C. Sundaramoorthy
10.	International Summit on Rheology and Nanotechnology	Mumbai	17-09-2008	Shri Achchhelal Yadav

CIRCOT ANNUAL REPORT 2008-2009

Sr. No.	Meetings / Conferences / Seminars / Symposia, etc.	Place	Date	Participants
11.	National Seminar <i>cum</i> Exhibition on Developments in Pulp, Paper and Printing Technology	Mumbai	18-09-2008 to 21-09-2008	Shri Ashok Kumar Bharimalla
12.	Datamining using SPSS Celmentine 12.0	Hyderabad	27-09-2008 and 28-09-2008	Dr. C.D. Ravindran
13.	Agrotextiles Emerging Opportunities	Mumbai	01-10-2008	Dr. R.H. Balasubramanya Dr. R.P. Nachane Dr. A.J. Shaikh Shri Ashok Kumar Bharimalla
14.	Hindi Seminar and Workshop	Goa	23-10-2008	Shri P.G. Patel Shri M.B. Kubdekar
15.	All India Language Seminar	Mumbai	03-10-2008 to 05-10-2008	Smt. K.R. Joshi Smt. T.P. Mokal
16.	IBM Software Universe '08	Mumbai	11-11-2008 and 12-11-2008	Shri D. Radhakrishna-murthy
17.	49th Annual Conference of the Association of Microbiologists' of India : <i>International Symposium on Microbial Biotechnology : Diversity, Genomics and Metagenomics</i>	New Delhi	18-11-2008 to 20-11-2008	Dr. R.H. Balasubramanya
18.	62nd Annual Conference of Indian Society of Agricultural Statistics (ISAS)	Tirupati	24-11-2008 to 26-11-2008	Dr. C.D. Ravindran Shri D.V. Mhadgut
19.	Workshop on Making Profits through Carbon Credits Trading -Emerging Business Opportunities	Mumbai	13-12-2008	Dr. P.V. Varadarajan Shri C. Sundaramoorthy
20.	Indian Rubber Manufacturers Research Association (IRMRA) 20th Rubber Conference	Thane	19-12-2008 and 20-12-2008	Dr. S.K. Chattopadhyay Shri Ashok Kumar Bharimalla
21.	International Ergonomic Conference HWWE 2008	Pune	22-12-2008 and 24-12-2008	Shri V.G. Arude

PARTICIPATION IN CONFERENCES, MEETINGS, WORKSHOPS, SYMPOSIA

Sr. No.	Meetings / Conferences / Seminars / Symposia, etc.	Place	Date	Participants
22.	International Conference on Global Textile Opportunities Vision India	Mumbai	16-01-2009 and 17-01-2009	Dr. R.H. Balasubramanya Dr. R.P. Nachane Dr. S.G. Gayal Shri R.M. Gurjar Dr. A.J. Shaikh Shri D.V. Mhadgut
23.	Workshop on Translation	Mumbai	19-01-2009 and 23-01-2009	Smt. K.R. Joshi
24.	HPTLC – A Modern Versatile Analytical Tool	Mumbai	06-02-2009 and 07-02-2009	Dr.(Smt.)Sujatha Saxena
25.	Demystifying the New US Regulation – CPSIA & REACH	Mumbai	13-02-2009 and 14-02-2009	Dr.(Smt.)Sujatha Saxena
26.	11th Indian Agricultural Scientists and Farmers' Congress	Allahabad	14-02-2009 and 15-02-2009	Dr. R.P. Nachane
27.	Emerging Trends and Challenges for Textile Industry in Recent Times	Mumbai	27-02-2009 and 28-02-2009	Shri Achhelal Yadav Shri R.K. Jadhav Smt. Bindu Venugopal Shri Monish Tembhare
28.	Seminar on Technological Advances in Indian Pulp and Paper Industry	New Delhi	06-03-2009 and 07-03-2009	Dr. A.J. Shaikh
29.	Workshop on Entrepreneurship	Mumbai	24-03-2009	Dr. P.V. Varadarajan

10

Workshops, Seminars, Summer Institutes, Farmers' Day, etc. Organised by CIRCOT

Review Meeting of the CFC Funded Project on Utilisation of Cotton Stalks for Value Added Products

The Fourth Review Meeting of the CFC funded project on **Utilisation of Cotton Stalks for Value Added Products** was held on August 30, 2008 at CIRCOT, Mumbai. Dr. S. Sreenivasan, Director, CIRCOT and Chairman, Review Committee, welcomed the members and outlined the salient achievements made in the project and also the problems faced during the establishment of cotton stalk supply chain. Dr. R.H. Balasubramanya, P.I. of the project presented the progress report of the project along with the action taken report on the suggestions made during the Third Review Meeting. He also outlined the targets set for 2007-08, the findings and the problems encountered during implementation in addition to the targets for 2008-09. Some of the key suggestions/points that emerged out of the deliberations are as follows:

- There is a good scope for setting up more number of board industries in the coming years.
- Excise duty on the boards prepared from crop residues should be exempted in order to promote broad based utilisation of the agro materials.
- All available crop residues in a region should be put to use when an industry is set up.
- A common facility for chipping to be set up in rural areas and KVKs to act as collection centres for stalks.
- Days are not far ahead for the board industry to claim carbon credit from the government since the carbon gets locked in agro-residues to boards.
- The logistics of cotton stalk supply chain management is a crucial aspect and this remains even today fluid and rigorous attempts to be made during the current year.
- Bagasse is not to be compared with cotton stalks as it comes from an organised sector.

The meeting ended with a vote of thanks to the Chair.



Fourth Review Meeting of the CFC Funded Project (30.8.2009) on Utilisation of Cotton Stalks for Value Added Products in progress

Hindi Day/Fortnight Celebrations

Hindi Fortnight Celebration at CIRCOT was inaugurated by Shri P.N. Khanna, Writer and Poet on September 15, 2008. Shri Ratilal Shani, Satirist and Shri Kumar Shailendra, Writer were the Guests of Honour at the inaugural function. The programme was inaugurated by lighting of the lamp by Guest of Honour. *Aushbhashan* and *kavya pathan* competitions were held on the same day.

Various competitions like *Shudhalekhan*, *Nibandh lekhan*, *Alekhan tippan*, *Takniki vakyansh*, *Muhavara arth prayog*, *Kavita rachana*, *Varg paheli*, *Bees sawal*, *poster presentation*, *Antakshari* and *Vak pratiyogita* were organized during September 15 – 23, 2008. The subject for the poster presentation was ***Prakritik Resha aur unki Upayogita*** (Natural fibre and their utilization). On the concluding day a debate on ***Mobile phone shap ya vardan*** was organized. The Chief Guest



Dr. S. Sreenivasan, Director, CIRCOT looking at one of the posters organised during the Hindi Fortnight Celebration. Shri B. R. Pawar, Technical Officer, T-5 is seen along with him

for the concluding function Shri Chandrashekar Nair, former Director of Films Divisions and Film Producer presented the Certificates to the winners. During his speech the Chief Guest exhorted the audience by saying that promotion of regional languages would automatically promote Hindi.

The Trophies for the year 2007-2008 for carrying out maximum work in Hindi was given to Dr. R.H. Balasubramanya Head, CBPD and to

Shri V.M. Kasabe, Jr. Accounts Officer. Shri Sanwarmal Saini Technical Assistant T-1, Smt. V.V. Desai, Assistant, Smt. S.R. Shirsat, U.D.C., Smt. S.G. Parab and Shri A.R. Gujar L.D.C.s were awarded certificate and cash prizes under the incentive scheme for carrying out maximum work in Hindi during 2007-08. The concluding programme was telecast on Sahyadri channel of Doordarshan on September 27 and in Amchi Mumbai on September 28.



*Shri A.R. Gurjar, L.D.C. one of the staff member debating on the topic **Mobile phone shap ya vardan***



Shri V.M. Kasabe, Jr. Accounts Officer receiving the trophy on behalf of Accounts Section for carrying out maximum work in Hindi during 2007-2008

Vigilance Awareness Week Celebration

The Vigilance Awareness Week was celebrated at CIRCOT, Mumbai from November 3 to 7, 2008. Dr. S. Sreenivasan, Director, CIRCOT inaugurated the function. Staff members were administered oath on November 3. Talks by eminent persons connected with vigilance were held during the week.

On November 5, an essay competition was held on the topic **How Effective is our Current Vigilance Mechanism in a Government Research and Development Organisation?**. The competition was held in three languages viz. Hindi, Marathi and English. The following were the winners:

Hindi	I Prize	Smt. N.M. Deshmukh, U.D.C.
	II Prize	Shri Chitranayak, Scientist
Marathi	I Prize	Shri M.B. Gurve, Skilled Supporting Staff Gr. IV
	II Prize	Smt. H.G. Pednekar, Technical Assistant T-3
English	I Prize	Smt. V.V. Desai, Assistant

Shri S.K. Sharma, Sr. Deputy General Manager, Central Railway, CST, Mumbai and Shri Arun Mehta, Dy. C.V.O., delivered lectures on Vigilance Awareness. All the staff members attended these lectures on all days and were highly benefited by the deliberations.



Smt. N.M. Deshmukh, U.D.C. receiving the first prize from Shri S.K. Sharma, Sr. Deputy General Manager, Central Railway, CST, Mumbai

Quami Ekta Week

Quami Ekta Week was celebrated at the Institute during November 19 – 25, 2008. The staff were administered Oath on November 19 and on November 22, an essay competition on the topic **Is India Communal or Secular Country?** was conducted. Along with this, Flag day was observed on 24th November 2008 wherein all employees of the Institute contributed financially towards rehabilitation of physically handicapped children. The following were the winners in the essay competition:

Dr. Nawab Ali, DDG (Engg.), ICAR,

Hindi	I Prize	Smt. N.M. Deshmukh, U.D.C.
	II Prize	Shri N.D. Kambli, Technical Assistant T-3
Marathi	I Prize	S.N. Bandre L.D.C.
	II Prize	Shri M.B. Gurve, Skilled Supporting Staff Gr.IV
English	I Prize	Shri P.S. Deshmukh, Scientist

New Delhi and Dr. Dhananjay Vanjari, ACP, ATS, Mumbai) gave lectures on Communal Harmony during the celebrations.

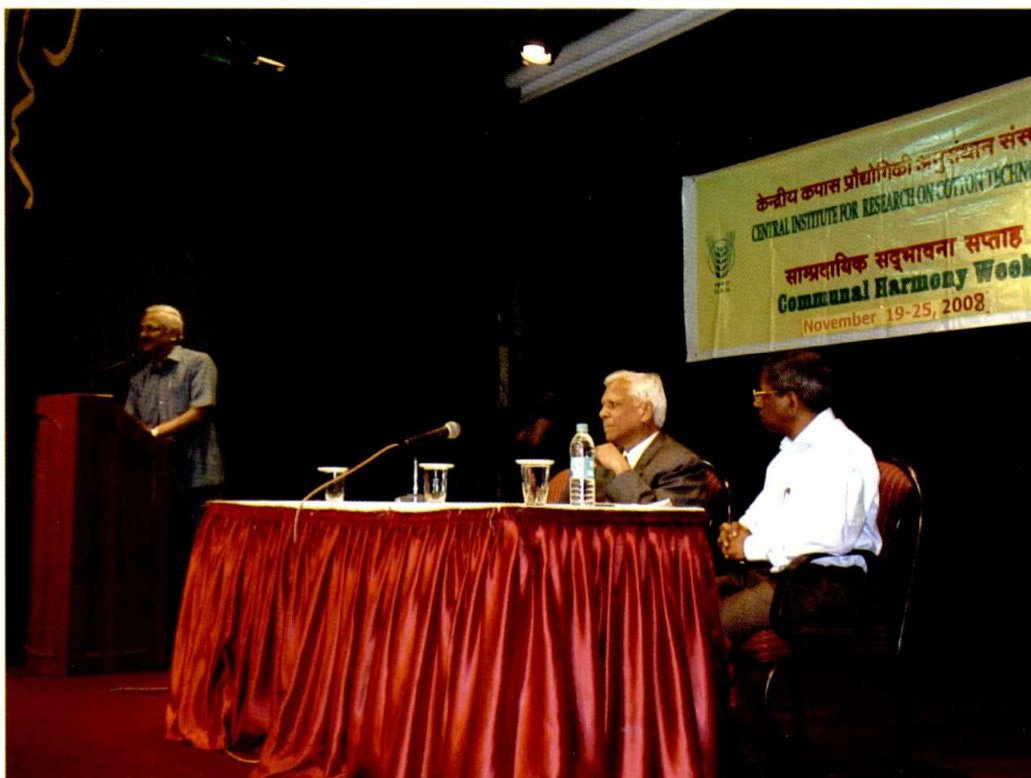

Dr. S. Sreenivasan, Director, CIRCOT in his welcome address on Communal Harmony Week Celebration. Seen in the dais are Dr. Nawab Ali, DDG (Engg.), ICAR, New Delhi and Dr. R.H. Balasubramanya, Head and Principal Scientist



Dr. Dhananjay Vanjari, (ACP, ATS, Mumbai) on Communal Harmony

Launch Workshop of the NAIP Project on Synthesis and Characterization of Nano-Cellulose and its Application in Biodegradable Polymer Composites to Enhance Their Performance

The Launch Workshop of the above project under component 4 of the National Agricultural Innovation Project (NAIP) was held on December 3, 2008. Prof. Dulal Panda, Head, School of Biosciences and Bioengineering, IITB, Mumbai was the Chief Guest. Dr. S.K. Tandon ADG (Engg), ICAR was the Guest of Honour. All the Scientists and faculty members both from CIRCOT and MUICT pertaining to the project attended the workshop. Dr. S. Sreenivasan, Director CIRCOT, welcomed all the members and introduced CIRCOT and its collaboration

with MUICT in this NAIP subproject. A booklet on **A Status Report on Nanocellulose and its Bio-nanocomposites** was released by Prof. Panda on this occasion.

Dr. A. Bandyopadhyay while welcoming the gathering briefly presented the highlights about NAIP and its fourth component. This was followed by a brief presentation about the subproject and its importance in the current scenario by Dr. Vigneshwaran, Consortium Principal Investigator. Dr. Tandon addressed the gathering bringing to fore the importance of nanotechnology and its application in agriculture. He also emphasised the need for collaborative research projects between biologists and engineers in such a multidisciplinary research field. Dr. Dulal Panda appreciated the efforts of

CIRCOT and MUICT in bringing this collaborative effort in a cutting edge research of nanotechnology.

Dr. Panda highlighted the effort being taken by IIT, Bombay in consolidation of its Nanotechnology research activities through the

formation of a Centre for Research in Nanotechnology & Science (CRNTS). He expressed interest in extending the facilities at IITB to provide support to carry out this subproject successfully. Dr. R.H. Balasubramanya, Head, Chemical and Biochemical Processing Division, proposed the Vote of Thanks.



Prof. Panda releasing the booklet on A Status Report on Nanocellulose and its Bio-nanocomposites

Awareness Meet

1. Awareness Workshop on Cotton Value Chain at Kothampaddi village near Attur in Salem District, Tamil Nadu, on July 3, 2008 to brief the farmers about the cotton value chain project and, their expected role. This meet was conducted for the farmers who were interested in joining the NAIP – CVC project.

This meeting was chaired by Dr. S. Sreenivasan, Director, CIRCOT.

2. Farmers Awareness Meet at Vadapudur village in Pollachi, Tamil Nadu, on September 26, 2008.
3. Farmers Awareness Meet at Babhulgaon in Yeotmal District, Maharashtra on October 7, 2008. In this meet Dr. R.P. Nachane,

Principal Investigator of the cotton value chain project explained the farmers about the project and their role. Expected output and benefits for the farmers were also explained by him. Their various queries were also answered.

4. Clean Cotton Picking workshop at Babhulgaon, Yeotmal District, Maharashtra on November 18, 2008. The farmers were explained about the practices of clean picking

of cotton and collection of cotton stalks.

5. Awareness workshop on Clean Cotton picking at Vadapudur village in Pollachi, Tamil Nadu, on December 2, 2008. The farmers were taught about the latest agricultural practices in cotton cultivation to get more yield, importance of reducing contamination in the lint and 'do's and 'dont's in cotton picking.



Dr. A.J. Shaikh, Head, TTD addressing the farmers at Vadapudur village in Pollachi, Tamil Nadu on September 26, 2008.

Dr. R.P. Nachane, Principal Scientist and Head, QEID giving bouquet to a farmer at the Farmers Awareness Meet at Babhulgaon in Yeotmal District, Maharashtra on 18-11-2008



Lectures

During the year the following lectures were arranged at the Institute on various topics by different experts. The following are the details:

1. Recruitment and Assessment of Scientists by Dr. A.K. Tyagi, Member, ASRB on April 8, 2008.
2. Agri Scenario in Temperate and Cold Arid Climate of Jammu and Kashmir by Prof. Anwar Alam, Vice Chancellor, Vice Chancellor, Sher-e-Kashmir University of Agricultural Science and Technology and Chairman, RAC on April 16, 2008.
3. Using the e-Resources in Agriculture on the Web by Dr. Maya Avasia, Education and Training Consultant, Informatics (India) Ltd. on September 8, 2008.
4. *CIRCOT Mein Raj Bhasha Karyanvan* by Shri Chitranayak, Scientist in ASHIRWAD's Hindi Seminar at Goregaon (W), Mumbai on September 10, 2008.
5. Catching with Time : Some Thoughts on Agricultural Research and Education System during the XI Five Year Period and Beyond by Dr. Mruthyunjaya, National Director, NAIP, New Delhi, on January 24, 2009.

NAIP Launch Workshop on the Zonal Technology Management and BPD unit at CIRCOT

Indian Council of Agricultural Research under National Agricultural Innovation Project scheme has set up a Zonal Technology Management and Business Planning & Development (BPD) unit at CIRCOT, Mumbai. The launch workshop of this unit was inaugurated by Dr. Mruthyunjaya, National Director, NAIP, New Delhi on January 24, 2009 at CIRCOT. Dr. S. Sreenivasan, Director, CIRCOT welcomed the audience. Dr. N.T. Yaduraju, National Coordinator, Component-I, NAIP, New Delhi gave a brief account of NAIP projects. In the Inaugural address Dr. Mruthyunjaya, mentioned that since the NAIP finding for research projects is new to India, it is a sort of an experiment and the entire world is watching as how the NAIP is going to be successful in India. He reminded that not all the technologies are viable. This has to be examined by a person with a business background who would liaison between the industry and the institute. Finally, he remarked that the technologies have to be protected but at the same time it has to fulfill all the objectives set in by the Institute. Dr. N. Shanmugam, Principal Investigator presented an account of the ZTM-BPD-CIRCOT proposal. This was followed by an interactive session with the stake holders. The meeting ended with a Vote of Thanks proposed by Dr. P.V. Varadarajan, Principal Scientist.



Dr. Mruthyunjaya, National Director, NAIP, New Delhi lighting the lamp to mark the Launch of the Workshop on the Zonal Technology Management and BPD unit at CIRCOT

National Science Day

To inculcate scientific temperament among the public, to popularize science, and to commemorate the discovery of Raman Effect by the Indian Physicist and Nobel Laureate Sir C.V. Raman, every

year February 28 is celebrated as the National Science Day as per the directives from the Government of India. On this day Shri B.B. Daundkar, Dy. Director, Forensic Laboratory, Mumbai gave a talk on **Recent Developments in Forensic Science.**

Shri B.B. Daundkar, Dy. Director, Forensic Laboratory, Mumbai making a point during the lecture on the occasion of National Science Day



International Women's Day

The International Women's Day was celebrated during the year on March 9, 2009. The theme for the year 2009 was **Women and Men United to End Violence against Women and**

Girls. On this occasion Kum. Najma, Advocate, Indian Centre for Human Rights and Law, Mumbai gave a talk on Women's Rights in Offices. During this function, winners of various events in the ICAR Zonal Sports meet held at CIFE, Mumbai were felicitated.



Smt. Kiran Joshi, Technical Assistant T-4 receiving a prize from Smt. Nagma, Advocate, Indian Centre for Human Rights and Law, Mumbai

Training for Supporting Staff

A six days training was imparted to the Supporting Staff from March 16-21, 2009 on matters pertaining to general administration and accounts. Day to day activities in various

administrative and accounts section were explained through lectures by various office personnel. This was organized in order to place them in the PB1 grade as per the recommendations of the VI Pay Commission.

Shri V. Murugan, one of the Supporting Staff receiving a Certificate from Shri K.W. Khamkar, A.A.O after Completing the Training



11

Distinguished Visitors

1. Shri Sharad Pawar, Hon. Union of Minister of Agriculture, Consumer Affairs, Food and Public Distribution, Govt. of India, New Delhi on November 1, 2008.
2. Dr. N.K. Tyagi, Chairman, Agricultural Scientists' Recruitment Board, Pusa, New Delhi on April 8, 2008.
3. Mr. B.A. Coutinho, IAS, Additional Secretary & Financial Advisor, DARE on July 22, 2008.
4. Fourth CFC Review Committee Members on August 30, 2008.
 - Dr. R.P. Kachru, former ADG (P.E.), ICAR, New Delhi
 - Dr. Pitam Chandra, ADG (P.E.), ICAR, New Delhi
 - Shri V.S. Raju
 - Shri Suresh Kotak, President, COTAP Research Foundation, Mumbai
 - Dr. C.N. Pandey, Director, Indian Plywood Industries Research and Training Institute, Bangalore
 - Dr. Anupam Barik, Director, Directorate of Cotton Development, Mumbai



Dr. S.K. Chattopadhyay, Head, MPD explaining the activities of his Division to Dr. N.K. Tyagi, Chairman, Agricultural Scientists Recruitment Board, ICAR, New Delhi



Mr. B.A. Coutinho, IAS, Additional Secretary & Financial Advisor, DARE in discussion with Dr. S. Sreenivasan, Director and Dr. R.H. Balasubramanya, Principal Scientist and Head, CPBD

DISTINGUISHED VISITORS

5. Eight delegates of ITMF delegation on October 17, 2008.

- Mr. Andrew Macdonald, Chairman, Spinners Committee (Brazil)
- Mr. Ziad Bashir, Member, Spinners Committee (Pakistan)
- Mr. Warner Bieri, Member, Spinners Committee (USA)
- Mr. B.K. Patodia, Member, Spinners Committee (India)
- Mr. Jung-Soo Kim, Member, Spinners Committee (Korea Rep.)
- Mr. Fritz Grobien, Special Invitee (Germany)
- Dr. Christian Schindler, Director General, ITMF (Switzerland)
- Mr. Suresh A. Kotak

6. Dr. Nawab Ali, Deputy Director General (Engg.), ICAR, New Delhi November 25, 2008.

7. Dr. H.P. Singh, DDG (Horticulture), ICAR, New Delhi on January 3, 2009.

8. Dr. Vazid Ali, Reader, Dept of Chemistry Chaudhary Devi Lal University, Sirsa (visit to Sirsa Q.E. Unit) on 24.2.2009

9. Dr. N. Gopalkrishnan, Project coordinator & Head, CICR, Coimbatore on March 3, 2009 (for Management Committee Meeting).



Dr. Nawab Ali, Deputy Director General (Engg.), ICAR inaugurating Dr. V. Sundaram Hall at the Institute on November 25, 2009.



Dr. S. Sreenivasan, Director, CIRCOT receiving Mr. Andrew Macdonald, Chairman, Spinners Committee (Brazil) along with other delegates as part of the visit of the ITMF delegation on October 17, 2008.

10. Dr. V. Subramaniam, Prof. and Head, Dept. of Textiles, Anna University, Chennai and Chairman, QRT

11. Dr. T.K.S. Gowda, Director, Instructions (PGS), UAS, GKVK Campus, Bangalore and Member, QRT

12. Dr. S. S. Narayanan, former Director, CICR, Nagpur and Member, QRT

13. Dr. H.V.S. Murthy, Prof. and Head, Dept. of Textiles, VJTI, Mumbai and Member, QRT

14. Members of the Fifteenth RAC Committee on March 21, 2009.

- Prof. Anwar Alam, Vice Chancellor, Sher-e-Kashmir University of Agricultural Science and Technology and Chairman, RAC
- Dr. N.S.L. Srivastava, Jt. Director, Sardar Patel Renewable Energy Research Institute, Gujarat and Member, RAC



Dr. H.P. Singh, DDG (Horticulture), ICAR, New Delhi in discussion with Dr. S. Sreenivasan, Director, CIRCOT

- Prof. C.D. Kane, Executive Director, DKTE College, Ichalkaranji, Maharashtra and Member, RAC
- Dr. B.M. Khadi, Former Director, Central Institute for Cotton Research, Nagpur and Member, RAC
- Prof. (Smt.) Niyati Bhattacharya, Retd. Professor, SNTD College, Mumbai and Member, RAC.

12

Infrastructural Facilities

Library : Besides the publications connected with cotton research, books of general interest have been constantly added to the library collection.

During 2008 – 2009, 122 new books were added to the library. This consisted of 28 books in Hindi and 94 books in English.

The total number of books by the end of March 2009 rose to 6857. With the addition of 100 bound volumes, the total number of journals stood at 7846. Out of 53 journals subscribed 29 were Indian publication and 24 foreign publications. Many journals were also received as complimentary or on exchange basis. The total financial outlay for the library during 2008 – 09 was Rs. 17 lakh. Five CDROM Database of ASTM and BIS standards, AATCC, World Textile Abstracts and TAPPI were subscribed on annual basis.

During the period 50 books dealing with IPR Patent copy Rights & Management, books on Agri-Business Management and IPR related books have been procured.

The facilities of the library are being utilized not only by the staff of the Institute but also by the students and

researchers from various colleges affiliated to Mumbai University, sister research institutions and personnel from the textile industry. Xerox service is provided to the visitors on request for a prescribed charge.

An On-line registration with Lexis Nexis, USA for **Total Patents** database under ITMU – IPR Fund was subscribed. With this, it is possible to access and retrieve data on any patent information worldwide. Apart from this, another database **India Patents** has been subscribed on yearly basis. This contains information from 1970 till date. This database is updated bi-monthly.

All the database services are available free of cost to any interested end-user.

During the reporting period the following major equipment were procured.

1. P.C. Server -2
2. Trash Separator
3. Bursting Strength Tester fully automatic digital model
4. Fabrication of Pneumatic Unit
5. Fabrication of UV Chamber for Photocablysis

- | | |
|---|--|
| 6. Spectrophotometer | 14. Moisture Management Tester |
| 7. Fabrication of Dish Device | 15. Vacuum Filtration Pump |
| 8. Rotary Digester | 16. Autoleveller Carding Machine |
| 9. Precision Air Conditioning Unit for Controlled Environment | 17. Autoleveller Draw frame |
| 10. High Energy Ball Mill for Production of Nano particles | 18. Digital Clamp on Power Meter & Digital Monometer |
| 11. Fluorescent Microscope with Digital Camera System | 19. Digital Moisture Meter |
| 12. Gas Chromatograph | 20. Image analyser |
| 13. High Resistance Meter | 21. Industrial Cleaner |
| | 22. IR Thermometer |

13

Personnel

Major events during 2008-2009 relating to CIRCCT personnel are listed below:

A. APPOINTMENTS

Sl. No.	Name	Grade to which Appointed	Date of Appointment
1.	Shri Mahesh C. Solanki	Supporting Staff Gr.I	21-2-2009

B. PROMOTIONS

Sl. No.	Name	Post to which Promoted	Effective Date of Promotion
Technical			
1.	Shri N.V. Bansode	Technical Officer T-6	14-2-2004
2.	Shri Gian Singh	Technical Assistant T-2	25-9-2005
3.	Smt. P.S. Nirali	Technical Officer T-5	20-11-2005
4.	Shri J.B. Dhodia	Technical Assistant T-1-3	23-11-2005
5.	Shri M.R. Nevrekar	Technical Assistant T-1-3	23-11-2005
6.	Shri T.S. Mhaske	Technical Assistant T-1-3	23-11-2005
7.	Shri B.K. Sawant	Technical Assistant T-1-3	16-12-2005
8.	Shri M.Y. Chandanshive	Technical Assistant T-1-3	17-12-2005
9.	Shri S.M. Sawant	Technical Assistant T-1-3	17-12-2005
10.	Shri R.K. Jadhav	Technical Officer T-6	18-12-2005
11.	Shri N.D. Kambli	Technical Assistant T-3	28-12-2005
12.	Shri R.R. Chhagani	Technical Officer T-6	5-8-2006
13.	Shri D.A. Salaskar	Technical Assistant T-1-3	29-6-2006

CIRCOT ANNUAL REPORT 2008-2009

Sl. No.	Name	Post to which Promoted	Effective Date of Promotion	
14.	Shri H.S. Koli	Technical Officer T-6	13-10-2006	
15.	Shri G.G. Mistry	Technical Officer T-6	1-1-2007	
16.	Shri D.N. Moon	Technical Officer T-6	1-1-2007	
17.	Shri R.R. Gosai	Technical Assistant T-2	23-4-2007	
18.	Shri D.M. Raje	Technical Assistant T-2	23-4-2007	
19.	Shri P.S. Panchbudhe	Technical Assistant T-2	2-5-2007	
20.	Dr. (Smt). S.R. Kawlekar	Technical Officer T-6	7-5-2007	
21.	Smt. C.D. Prabha	Technical Officer T-5	1-7-2007	
22.	Shri C.L. Mundale	Technical Assistant T-3	1-10-2007	
23.	Shri S.K. Parab	Technical Assistant T-1-3	1-10-2007	
24.	Dr. R.D. Nagarkar	Technical Officer T-(7-8)	1-1-2008	
25.	Shri N.K. Shaikh	Technical Assistant T-2	17-4-2008	
Advance Increment				
1.	Smt. K.R. Joshi	Sr. Technical Assistant T-4	Three Advance Increments	29-6-2006
2.	Shri M. Bhaskar	Sr. Technical Assistant T-4	„	21-9-2007
3.	Shri V.D. Kalsekar	Sr. Technical Assistant T-4	„	29-4-2007

C. UPGRADATION

Smt. S.R. Shirsat, Upper Division Clerk has been upgraded in the pay scale of Rs. 5500-175-9000 from June 28, 2008.

D. RETIREMENTS**Scientist**

Dr. K.M. Paralikar, Principal Scientist and Head, T.T.D. retired on 30-06-2008.

Technical

1. Smt. S.V. Sukhi, Technical Officer (T-8) retired on 31-05-2008.
2. Shri Ram Parkash, Technical Officer (T-9) retired on 31-08-2008.
3. Shri R.M. Modi, Technical Officer T-6 retired on 31-11-2008.

PERSONNEL

4. Shri M.R. Nevrekar, Technical Assistant T-(1-3) retired on 31-12-2008.
5. Shri H.S. Bhabar, Technician (T-1) retired on 10-01-2009.

Supporting

1. Shri L.R. Indurkar, Supporting Staff Gr. IV retired on 30-04-2008.

2. Shri V.M. Subramaniam, Supporting Staff Gr. IV retired on 30-09-2008.
3. Shri K.M. Rathod, Supporting Staff Gr.IV retired on 1-1-2009.

Resignation

1. Dr. P.G. Patil, Sr. Scientist resigned w.e.f. 24-12-2008.
2. Shri A.K. Chaphekar, Sr. Technical Assistant w.e.f. 31-7-2008.

E. TRAINING

Sl. No.	Name of the Training Programme	Period and Place	Participant(s)
1.	Disaster Management	April 1-17, 2008 Civil Defence College, Nagpur	Shri S.M. Chandanshive
2.	Graduate Course in IPR & Technology Transfer	April 13-16, 2008 Ooty, Tamil Nadu	Dr. R.P. Nachane
3.	Training on Intellectual Property Rights and World Trade Organisation Related Issues for Senior Scientists	April 28-May 2, 2008 New Delhi	Dr. (Smt.) Sujatha Saxena
4.	Technical and Administrative Support for Consortia based Research in Agriculture	May 21-27, 2008	Smt. V. Bindu
5.	Training Course on Technical & Administrative Support for Consortia based Research in Agriculture	May 21-27, 2008 NAARM, Hyderabad	Smt. M.V. Kamerkar Smt. S. Koshy
6.	Training <i>cum</i> Workshop on IP & Technology Management in ICAR System	June 10-12, 2008 CIFE, Mumbai	Shri Ashok Kumar Bharimalla Shri C. Sundaramoorthy Shri Achchhelal Yadav Shri Virendra Prasad Shri Chitranayak

CIRCOT ANNUAL REPORT 2008-2009

Sl. No.	Name of the Training Programme	Period and Place	Participant(s)
7.	Workshop on Upgradation of Communication Skills	July 14-19, 2008 Extension Education Institute, Anand, Gujarat	Shri R.K. Jadhav
8.	Training on Pay Fixation Rules	August 4 -6, 2008 ISTM, New Delhi	Smt. S.R. Shirsat Shri J.R. Mangale
9.	Management Development Programme on Performance Assessment of Agricultural Research Organisations	Sept. 16-20,2008 NAARM, Hyderabad	Dr. S.K. Chattopadhyay Shri C. Sundaramoorthy
10.	Refresher Course in Physics	October 3-23, 2008 Academic Staff College, University of Mumbai	Shri Achchhelal Yadav
11.	Refresher Course in Chemistry	October 6-25, 2008 Academic Staff College, University of Mumbai	Shri Virendra Prasad
12.	Training Programme on Price Trend and Market Integration	October 16-25, 2008 IASRI, New Delhi	Shri C. Sundaramoorthy
13.	Training on PME Support for Consortia based Research Projects in Agriculture	October 21-25, 2008 NAARM, Hyderabad	Dr. R.P. Nachane Dr. S. Venkatakrisnan
14.	3 rd Management Development Programme on Leadership Development	November 3-17, 2008 IIM, Lucknow	Dr. R.P. Nachane
15.	Training on Financial Management System under NAIP	November 20-21,2008 CIFE, Mumbai	Shri R.K. Singh Shri S.V. Kasabe Shri J.R. Mangale
16.	International Training Programme on Nanotechnology for Energy Applications	December 1-12, 2008 IIT, Mumbai	Dr. N. Vigneshwaran
17.	<i>Mastishk Manthan</i> Training Programme	December 2-3, 2008 NAARM, Hyderabad	Smt. T.P. Mokal

PERSONNEL

Sl. No.	Name of the Training Programme	Period and Place	Participant(s)
18.	Training Course on Technical & Administrative Support for Consortia based Research in Agriculture	December 8-17, 2008 NAARM, Hyderabad	Shri D.L. Upadhye Shri S.N. Salve
19.	National Level Training of Traders. Improvement of Cotton Quality under TMC (MM.2)	December 28-29, 2008 Rajkot	Dr. S.B. Jadhav
20.	Training on High Quality Services in Guest House	February 20-21, 2009 IIT, Mumbai	Shri S.V. Kokane
21.	Training Programme on Decision Support Tools & Techniques	March 2-6, 2009 ASCI, Hyderabad	Dr.(Smt.) Sujatha Saxena
22.	Training Programme on Harnessing Intellectual Property for Collaborative Advantage	March 2-6, 2009 IIM, Ahmedabad	Dr. N. Shanmugam
23.	Training Programme on Remote Sensing & GIS Application in Soil Level & Agriculture	Feb. 9-March 1, 2009 NBSS & LUP, Nagpur	Shri V.G. Arude
24.	Training Programme on IT based Decision Support System using Open Source Systems for e-learning	March 11-20, 2009	Shri D. Radha-krishnamurthy

E. ACCOLADES

Awards

The Institute has bagged the III prize in the form of a Shield for carrying out best work in Hindi by ASHIRWAD, a Literary-Socio-Cultural Organisation, Mumbai. Smt. Kiran Joshi, Sr. Technical Assistant T-4, received a Shield and a Certificate for carrying out best work in Hindi at the Institute.



Smt. Kiran Joshi, Sr. Technical Assistant T-4 with the Shield received for carrying out best work in Hindi at the Institute from ASHIRWAD

Dr. (Smt.) Sudha Tiwari, Technical Officer T-6 received I prize for her article entitled *Kuposhan ki Jung Binole Protein Ke Sang*; Shri Chitranayak, Scientist and Dr. (Smt.) Sudha Tiwari, Technical Officer T-6 were awarded II prize for their article entitled *Paryavaran Maitri*

Sambadh Vastra Utpadan in the 26th All India Scientific and Technical Article Competition organised by Kendriya Sachivalaya, Hindi Parashed at Teen Murti Bhawan, New Delhi on February 26, 2009.



Dr. (Smt.) Sudha Tiwari, Technical Officer T-6 and Shri Chitranayak, Scientist receiving Memento and Certificate from Shri Mahabir Prasad, Hon'ble Union Minister, Ministry of Union, Micro, Small and Medium Enterprises, Govt. of India for Best Technical article in Hindi



F. FOREIGN DEPUTATION

Shri Ashok Kumar Bharimalla, Scientist was deputed for training in **Cotton Processing for Superior Quality Yarn** under ICAR – ARC Egypt Work Plan for 2007-08 at Egypt from April 12 to May 02, 2008.

ICAR Inter-Institutional Sports Meet

ICAR Inter-Institutional Western Zonal

Sports Meet was held at CIFE, Mumbai from February 2-4, 2009. The contingent had 54 sports personnel representing CIRCOT with Shri P.S. Deshmukh, Scientist as *Chief-de-Mission* and Shri M.G. Ambare, Technical Assistant T-3, as Manager. The Institute actively participated in Chess, Carom, Volleyball, Kabbadi, Table Tennis, Badminton and 100 x 4 m relay.

In the team event for men, the Institute

PERSONNEL

won in Table Tennis and 100 x4 m relay. In individual event for men, Shri R.S. Prabudesai, Technical Officer T-6, won II prize in chess, Shri S.K. Parab, Technical Assistant T-1-3, I prize in carom; Shri N.V. Kamble, Upper Division Clerk came II in 100 m and III position in 200 m. Shri M.G. Ambare bagged III position in 400 m. Shri D.M. Raje, Technical Assistant T-2 received Special prize for his participation in Cycle Race in the general category.

Smt. S.P. Paiyala, Lower Division Clerk won I prize in Table Tennis single,

Doubles and II prize in Badminton single, Doubles and in Carom. Smt. P.S. Nirali, Technical Officer T-5 won I prize in Table Tennis doubles and II in Badminton doubles. Smt. T.T. D'Souza, Personal Assistant won II prize in discuss throw. Smt. Sandhya Parab, Lower Division Clerk won II prize in Table Tennis Single. Smt Hemangi Pednekar, Technical Assistant T-3 won III prize in 100 m race.

It is heartening to mention that the Institute became the Overall champion for the Western Zone amongst 18 participating Institutes.



CIRCOT Sport Contingent with Medals

**STAFF WORKING AT THE
CENTRAL INSTITUTE FOR RESEARCH ON COTTON TECHNOLOGY
AS ON 31-03-2009**

(List does not include vacant posts)

LIST OF STAFF AT THE HEADQUARTERS

Scientific Personnel

Director

Dr. S.Sreenivasan, M.Sc., Ph.D., F.T.A., C.Text, F.T.I.

Principal Scientist & ead of Division

- | | |
|---|---|
| 1. Dr. R. H. Balasubramanya, M.Sc.
(Agri.), Ph.D., F.T.A., C.Text. F.T.I | 2. Dr.R.P. Nachane, M.Sc., Ph.D. , F.T.A.,
C.Text., F.T.I. |
|---|---|

Principal Scientist

- | | |
|--|--|
| 1. Dr. S.K. Chattopadhyay,
B.Sc.Tech.(Text.),
M.Tech.(Text.Engg.), Ph.D. (Tech.),
F.T.A., C.Engg., F.I.E. | 2. Dr. S.G. Gayal, M.Sc., Ph.D.
3. Shri R.M. Gurjar, M.Sc.
4. Dr. A.J. Shaikh, M.Sc., Ph.D.
5. Dr. P.V. Varadarajan, M.Sc., Ph.D. |
|--|--|

Senior Scientist

- | | |
|---|--|
| 1. Dr. D.N. Makwana, M.Sc., Ph.D.
2. Dr. C.D. Ravindran, M.Sc., Ph.D.
3. Dr. (Smt.) Sujatha Saxena, M.Sc.,
Ph.D. | 4. Dr. S. B. Jadhav, M.Sc., Ph.D.
5. Shri D.V. Mhadgut, M.Sc. |
|---|--|

Scientist

- | | |
|--|---|
| 1. Shri Achchhelal Yadav, M.Sc.
2. Shri Ashok Kumar Bharimalla, M.Tech.
(Agril. Engg.)
3. Shri Chitranayak, AMIETE., M.Tech.
(Electronics)
4. Shri P. S. Deshmukh, M.Tech
(Agril. Engg.) | 5. Shri K.H. Sawakhande, M.Sc.
6. Dr. N. Shanmugam, M.Tech., MIE, D.T.T.,
C.Eng., Ph.D. (Tech)
7. Shri C. Sundaramoorthy, M.Sc.
8. Dr. N. Vigneshwaran, M.Sc. (Agri.),
Ph.D.
9. Shri Virendra Prasad, M.Sc. |
|--|---|

PERSONNEL

Technical Personnel

Technical Officer T (7-8)

1. Dr. S.J. Guhagarkar, M.Sc., Ph.D.
2. Dr. (Smt.) A.A. Kathe, M.Sc., Ph.D.
3. Shri P.K. Mandhyan, M.Sc., A.T.A.
4. Smt. N.D. Nachane, B.Sc.
5. Dr. R.D. Nagarkar, M.Sc., Ph.D.
6. Shri D. Radhakrishnamurthy, M.Sc., M.Phil.
7. Shri K.B. Rajagopal, B.Sc.
8. Shri S. Sekar, B.Sc.
9. Smt. R.K. Shahani, M.A., B.Lib.
10. Shri V.B. Suryanarayanan, B.Sc., D.F.L.(German)

Technical Officer T-6

1. Smt. N.M. Ashtaputre, M.Sc
2. Shri S. Banerjee, M.Sc.
3. Shri R.R. Chhagani, M.Sc.
4. Shri S.M. Gogate, B.Sc.
5. Shri G.B. Hadge, M.Sc.
6. Shri R.K. Jadhav, B.Sc.
7. Dr. (Smt). S.R. Kawlekar, M.Sc., P.I.M.R
8. Shri H.S. Koli, M.Sc., LL.B.
9. Dr. Matish Chandra, M.Sc., Ph.D.
10. Shri M. Mohan, M.Sc., Dip.J.
11. Shri D.N. Moon, B.Sc.
12. Shri C.M. More, M.Sc.
13. Dr. E.A. Pachpinde, M.Sc., Ph.D.
14. Shri R.S. Pathare, B.Sc.
15. Shri B.R. Pawar, M. Sc., LL.M.
16. Shri R.S. Prabhudesai, M.Sc., D.C.M.
17. Dr. (Smt.) Sheela Raj, M.Sc., Ph.D.
18. Dr. (Smt.) Sudha Tiwari, B.Sc., Ph.D.
19. Shri S. Vancheswaran, B.Sc.
20. Shri T. Venugopal, B.E.(Civil)
21. Shri M.V. Vivekanandan, M.Sc.

Technical Officer T-5

1. Smt. Bindu Venugopal, B.Sc.
2. Smt. Binu Sunil, M.Sc.
3. Shri B.B. Gaykar
4. Smt. K.K. Kale, B.A.
5. Shri D.U. Kamble, B.Sc.
6. Shri S.V. Kokane, B.A.
7. Shri R.R. Mahangade, M.Sc.
8. Smt. P.S. Nirali, M.Sc.
9. Smt. C.D. Prabha, M.Sc.
10. Shri P.N. Sahane, D.I.F.T.
11. Smt. N.A. Sonkusle, B.Sc.
12. Shri D.L. Upadhye, SSC (Tech.), D.M.E., N.C.T.V.T.(I.T.I.& C.T.I.)

Senior Technical Assistant T-4

1. Smt. P.R. Mhatre, B.Sc., M.Lib.
2. Kum. C.P. D' Souza, M.Sc.
3. Smt. K.R. Joshi, M.A. (Hindi Translator)
4. Shri V.D. Kalsekar, B.Sc.
5. Shri A.P. Modak, B.Text. (Textile Technology)
6. Shri R.S. Narkar, B.Sc., D.C.I.A.

Technical Assistant T-3

1. Shri M.G. Ambare, M.Sc.
2. Shri N.D. Kambli, B.Sc.
3. Smt. H.G. Pednekar, B.A.
4. Shri S. Patil, B.E. (Civil)

Category T-I-3

1. Shri A.R. Bane, Cert. Cot. Spin.
2. Shri M.B. Chandanshive, Cert.Cot.Spin.(Machinist/Fitter)
3. Shri M.Y. Chandanshive
4. Shri G.S. Deorukhkar, Cert. Cot. Spin.
5. Shri B.R. Jadhav
6. Shri T.S. Mhaske
7. Shri S.K. Parab, Cert. Cot. Spin.
8. Shri D.A. Salaskar
9. Shri B.K. Sawant
10. Shri S.M. Sawant
11. Shri C.V. Shivgan, H.S.C., Cert.Wireman, Cert.Electrician, Cert.Elec.Supr. (PWD),, Cert. M. & A.W.(Technician)
12. Shri S.A. Waghela
13. Shri G.G. Ambare

Technical Assistant T-2

1. Shri D.M. Correia, S.S.C., I.T.I., N.C.T.V.T. (Mechanic)
2. Shri R.R. Gosai
3. Shri R.P. Kadam, B.Sc.
4. Smt. M.P. Kamble, B.A., B.Lib.
5. Shri D.M. Raje
6. Shri M.K. Shaikh

Technical Assistant T-1

1. Shri M.M. Kadam
2. Shri S.G. Phalke
3. Shri Mahabir Singh

Auxiliary Personnel

Canteen staff

Smt. K.R. Khaire (Tea Maker & Dish Cleaner)

Administrative Personnel

Administrative Officer

Shri M.B. Khubdikar, B.A.

Finance and Accounts Officer

Shri R. K. Singh, M.Sc.

Jr. Accounts Officer

Shri S. V. Kasabe, B.Com., L.L.B.

PERSONNEL

Assistant Administrative Officer

1. Smt. M.V. Kamerkar, B.A.
2. Shri K. W. Khamkar, B.A.
3. Shri S. N. Salve
4. Smt. S. Koshy, B.Com.

Assistant

1. Shri B.D. Sawant
2. Shri A.B. Dalvi
3. Shri D.G. Kulkarni
4. Shri B.S. Bhenwal
5. Ms. S. Harrison
6. Smt. V.V. Desai
7. Smt. S.D. Ambre
8. Smt. T.P. Mokal, B.A.
9. Smt. S.M. Desai
10. Shri A.P. Natu
11. Smt. J.J. Karanjavkar
12. Shri K. Parleshwar
13. Smt. V.V. Janaskar, B.Com., M.A.

Private Secretary

Shri Venu Thanikal

Personal Assistant

1. Smt. S.D. Dudam, M.A.
2. Smt. T.T. Souza

Stenographer Gr. III

1. Smt. U.N. Bhandari
2. Smt. R.R. Tawde, B.Com.
3. Smt. Viniya Rajesh Naik, B.A.

Upper Division Clerk

1. Smt. S.R. Shirsat, B.A.
2. Shri N.V. Kambli
3. Smt. N.M. Deshmukh, M.A., LL.B.
4. Shri J.R. Mangale, B.Com.
5. Shri S.D. Ambolkar
6. Shri R.K. Pallewad, B.A.
7. Shri P.V. Jadhav

Lower Division Clerk

1. Smt. S.G. Parab, B.A.
2. Smt. S.P. Paiyala
3. Shri V.M. Sable
4. Smt. J.R. Chavkute
5. Smt. B.D. Kherodkar
6. Shri S.S. Angane
7. Shri A.R. Gujar
8. Shri T.D. Dhamange, B.Com.
9. Shri S.N. Bandre

Skilled Supporting Staff Gr.IV

- | | |
|---------------------|---------------------|
| 1. Shri M.Z. Rathi | 3. Shri R.B. Jadhav |
| 2. Shri N.J. Kharat | 4. Shri M.B. Gurve |

Skilled Supporting Staff Gr.III

- | | |
|-----------------------|----------------------|
| 1. Shri O.T. Thapa | 7. Smt. B.R. Piwal |
| 2. Shri B.R. Satam | 8. Shri D.B. Temgire |
| 3. Shri D.M. Chougule | 9. Shri C.S. Salvi |
| 4. Shri S.D. Gurav | 10. Shri K.T. Mahida |
| 5. Shri M.K. Ghadge | 11. Shri P.G. Gogale |
| 6. Smt. T.V. Bhowar | |

Skilled Supporting Staff Gr.II

- | | |
|-------------------------|--------------------------|
| 1. Shri M.M. Katpara | 10. Shri R.P. Karkate |
| 2. Shri M.A.A. Rashid | 11. Shri D.G. Gole |
| 3. Shri G.N. Mayawanshi | 12. Shri C.D. Acharekar |
| 4. Shri H.B. Vesmiya | 13. Shri M.K. Prabhulkar |
| 5. Shri M.J. Sumra | 14. Shri J.D. Sakpal |
| 6. Shri C.P. Solanki | 15. Shri V. Murugan |
| 7. Shri S.K. Bobate | 16. Shri S.B. Worlikar |
| 8. Shri P.P. Patil | 17. Shri S.D. Magar |
| 9. Shri R.G. Tak | 18. Shri S.R. Tondse |

Skilled Supporting Staff Gr.I

- | | |
|----------------------|---------------------------|
| 1. Shri V.B. Poojari | 6. Shri D.R. Gawde |
| 2. Shri S.P. Naik | 7. Shri S.S. Surkule |
| 3. Shri M.N. Kamble | 8. Smt. V.N. Walzade |
| 4. Smt. K.B. Thapa | 9. Shri S.M. Chandanshive |
| 5. Shri D.K. Kasar | 10. Shri P.E. Gurav |

PERSONNEL

LIST OF STAFF AT THE QUALITY EVALUATION UNITS

COIMBATORE

<i>Technical Officer T-6</i>	: Dr. S. Venkatakrishnan, MSc., Ph.D., A.T.A.
<i>Technical Officer T-6</i>	: Shri K. Thiagarajan, M.Sc.
<i>Sr. Technical Assistant T-4</i>	: Shri M. Bhaskar, Dip. Ref. & Air-Cond.

DHARWAD

<i>Technical Officer T-5</i>	: Shri K. Narayanan, B.Sc.
<i>Technician T-3</i>	: Kum. V.G. Udikeri, B.Sc.
<i>Skilled Supporting Staff Gr.III</i>	: Shri C.J. Bagalkoti
<i>Skilled Supporting Staff Gr.II</i>	: Shri A.F. Gudadur

GUNTUR

<i>Technical Officer T-6</i>	: Shri S. Mukundan, M.Sc.
<i>Skilled Supporting Staff Gr.I</i>	: Shri V. Subbaiah

NAGPUR

<i>Scientist</i>	: Smt. Jyoti M. Nath, M.Sc. : Dr. T.S. Manojkumar, M.E. (Agril.), Ph.D. (Agril. Processing) : Shri Sujeet Kumar Shukla, M.Tech (Mech. Engg.) : Shri Vishnu Govind Arude, M.Tech.
<i>Technical Officer T-7</i>	: Shri V.M. Kulmethe, B.Sc.
<i>Technical Officer T-6</i>	: Shri N.V. Bansode, B.Sc.
<i>Technical Officer T-5</i>	: Shri S.L. Bhanuse, B.Sc. : Shri U.D. Devikar, B.Sc. : Shri R. G. Dhakate, B.Sc. : Shri S.N. Hedau, B.Sc. : Shri V.L. Rangari, B.Sc.
<i>Technician T-3</i>	: Shri B.V. Shirsath, B.A., I.T.I. : Shri C.L. Mundale

CIRCOT ANNUAL REPORT 2008-2009

<i>Technician T-1-3</i>	: Shri B.H. Umredkar
<i>Technician T-2</i>	: Shri P.S. Panchbudhe, B.A.
<i>Technician T-1</i>	: Shri H.S. Bhabar : Shri S.V. Kokane
<i>Stenographer (Gr. III)</i>	: Shri R.D. Shambharkar, M.A.
<i>Senior Clerk</i>	: Shri B.D. Dhengale : Shri S.A. Telpande, M.Com.
<i>Skilled Supporting Staff Gr.III</i>	: Shri M.P. Tohokar
<i>Skilled Supporting Staff Gr.II</i>	: Shri A.R. Chutale : Shri J.P. Patel : Shri R.B. Kautkar : Shri R.G. Matel : Shri R.C. Rokde
<i>Skilled Supporting Staff Gr.I</i>	: Shri M.G. Bhandakkar : Shri R.S. Umare

SIRSA

<i>Technical Officer T-6</i>	: Dr. Hamid Hasan, M.Sc., Ph.D. : Dr. Jal Singh, M.Sc., Ph.D.
<i>Technician T-2</i>	: Shri Gian Singh
<i>Technician T-1</i>	: Shri Sanwarmal Saini
<i>Supporting Staff Gr.III</i>	: Shri Satyanarayan Gope

SURAT

<i>Technical Officer T-5</i>	: Shri G.G. Mistry, B.Sc. : Shri M.B. Patel, B.Sc., L.L.B.
<i>Technician T-2</i>	: Shri J.B. Dhodia
<i>Senior Clerk</i>	: Shri J.I. Parmar, B.Com.
<i>Skilled Supporting Staff Gr.IV</i>	: Shri K.M. Rathod
<i>Skilled Supporting Staff Gr.II</i>	: Shri M.G. Sosa